

HIGH-SIDE AND LOW-SIDE GATE DRIVERS IN SO-16
Description

The DGD2110 and DGD2113 are high-voltage/high-speed MOSFET and IGBT drivers with independent high-side and low-side outputs. The high-side driver features floating supply for operation at up to 500V/600V. The 10ns (max)/20ns (max) propagation delay matching between the high- and the low side drivers allows high-frequency operation.

The DGD2110 and DGD2113 logic inputs are compatible with standard CMOS levels (as low as 3.3V) while driver outputs feature high-pulse current buffers designed for minimum driver cross conduction.

The DGD2110 and DGD2113 are offered in a SO-16 package. They operate over an extended -40°C to +125°C temperature range.

Applications

- DC-DC Converters
- DC-AC Inverters
- AC-DC Power Supplies
- Motor Controls
- Class D Power Amplifiers

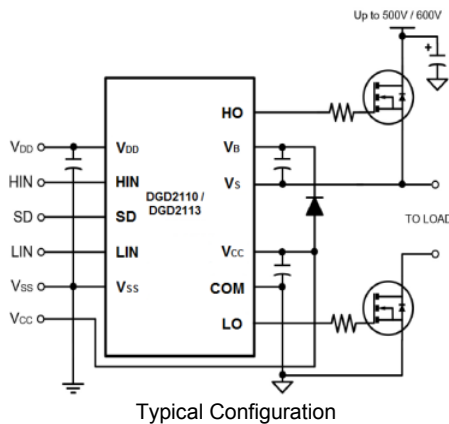

Typical Configuration

Features

- Drives two N-Channel MOSFETs or IGBTs in High-Side/Low-Side Configuration
- Floating High-Side Operates to 600V
- 2.5A Sink/2.5A Source Typical Output Currents
- Outputs Tolerant To Negative Transients
- Wide Gate Driver Supply Voltage Range: 10V to 20V
- Wide Logic Input Supply Voltage Range: 3.3V to 20V
- Wide Logic Supply Offset Voltage Range: -5V to 5V
- 15ns (typ) Rise/13ns (typ) Fall Times with 1000pF load
- 105ns (typ) Turn-On/94ns (typ) Turn-Off Delay Times
- Cycle-by-Cycle Edge-Triggered Shutdown Circuitry
- Extended Temperature Range: -40°C to +125°C
- **Totally Lead-Free & Fully RoHS Compliant (Notes 1 & 2)**
- **Halogen and Antimony free. "Green" Device (Note 3)**
- **For automotive applications requiring specific change control (i.e. parts qualified to AEC-Q100/101/200, PPAP capable, and manufactured in IATF 16949 certified facilities), please [contact us](mailto:contact@diodes.com) or your local Diodes representative. <https://www.diodes.com/quality/product-definitions/>**

Mechanical Data

- Case: SO-16 (Type TH)
- Case Material: Molded Plastic. "Green" Molding Compound.
- UL Flammability Classification Rating 94V-0
- Moisture Sensitivity: Level 3 per J-STD-020
- Terminals: Finish—Matte Tin Plated Leads, Solderable per MIL-STD-202, Method 208 (E3)
- Weight: 0.130 grams (Approximate)

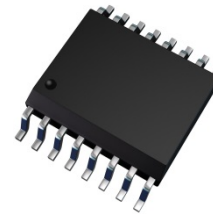
 SO-16
Top View

Ordering Information (Note 4)

Product	Marking	Reel size (inches)	Tape width (mm)	Quantity per reel
DGD2110S16-13	DGD2110	13	16	1500
DGD2113S16-13	DGD2113	13	16	1500

- Notes:
1. No purposely added lead. Fully EU Directive 2002/95/EC (RoHS), 2011/65/EU (RoHS 2) & 2015/863/EU (RoHS 3) compliant.
 2. See <https://www.diodes.com/quality/lead-free/> for more information about Diodes Incorporated's definitions of Halogen- and Antimony-free, "Green" and Lead-free.
 3. Halogen- and Antimony-free "Green" products are defined as those which contain <900ppm bromine, <900ppm chlorine (<1500ppm total Br + Cl) and <1000ppm antimony compounds.
 4. For packaging details, go to our website at <http://www.diodes.com/products/packages.html>.

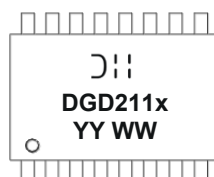
Marking Information

= Manufacturer's Marking
 DGD211x = Product Type Marking Code (See Table Above)
 YY = Year (ex: 19 = 2019)
 WW = Week (01 - 53)

Pin Diagrams

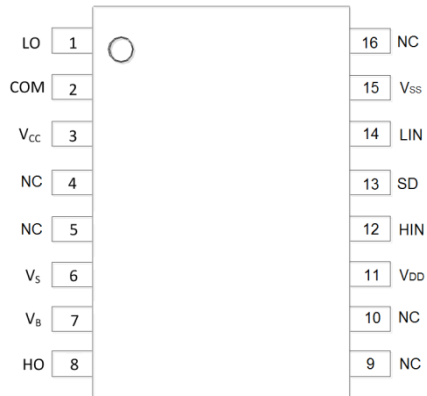

Top view: SO-16

Pin Descriptions

Pin Number	Pin Name	Function
1	LO	Low-side gate driver output pin
2	COM	Low-side gate driver power supply return pin
3	VCC	Low-side gate driver power supply pin
4,5,9,10,16	NC	No connect pin (No Internal Connection)
6	VS	High-side gate driver floating power supply return pin
7	VB	High-side gate driver floating power supply pin
8	HO	High-side gate drive output pin
11	VDD	Logic power supply pin
12	HIN	Logic input pin for high-side gate driver output. HIN and HO are in phase
13	SD	Logic input shutdown pin
14	LIN	Logic input pin for low-side gate driver output. LIN and LO are in phase
15	VSS	Logic ground pin

Functional Block Diagram

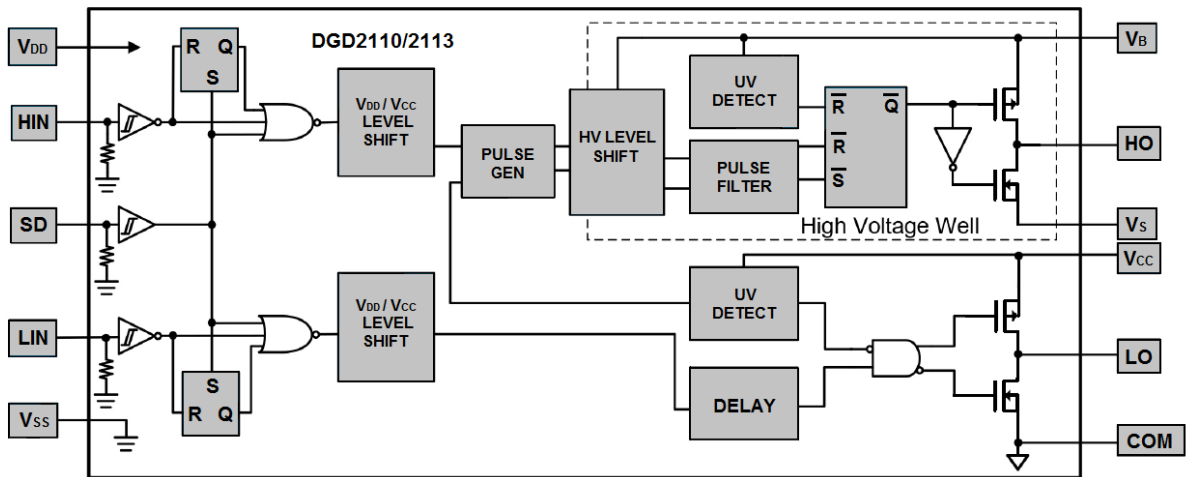

Absolute Maximum Ratings (@ $T_A = +25^\circ\text{C}$, unless otherwise specified.)

Characteristic	Symbol	Value	Unit
High-Side Floating Supply Voltage (DGD2110)	V_B	-0.3 to +524	V
High-Side Floating Supply Voltage (DGD2113)	V_B	-0.3 to +624	V
High-Side Floating Supply Offset Voltage	V_S	$V_B - 24$ to $V_B + 0.3$	V
High-Side Floating Output Voltage	V_{HO}	$V_S - 0.3$ to $V_S + 0.3$	V
Offset Supply Voltage Transient	dV_S / dt	50	V/ns
Low-Side Fixed Supply Voltage	V_{CC}	-0.3 to +24	V
Low-Side Output Voltage	V_{LO}	-0.3 to $V_{CC} + 0.3$	V
Logic Supply Voltage	V_{DD}	-0.3 to $V_{SS} + 24$	V
Logic Supply Offset Voltage	V_{SS}	$V_{CC} - 24$ to $V_{CC} + 0.3$	V
Logic Input Voltage (HIN, LIN, and SD)	V_{IN}	$V_{SS} - 0.3$ to $V_{DD} + 0.3$	V

Thermal Characteristics (@ $T_A = +25^\circ\text{C}$, unless otherwise specified.)

Characteristic	Symbol	Value	Unit
Power Dissipation Linear Derating Factor (Note 5)	P_D	1.25	W
Thermal Resistance, Junction to Ambient (Note 5)	$R_{\theta JA}$	90	$^\circ\text{C/W}$
Thermal Resistance, Junction to Case (Note 5)	$R_{\theta JC}$	45	$^\circ\text{C/W}$
Operating Temperature	T_J	+150	$^\circ\text{C}$
Lead Temperature (Soldering, 10 seconds)	T_L	+300	
Storage Temperature Range	T_{STG}	-55 to +150	

Note: 5. When mounted on a standard JEDEC 2-layer FR-4 board.

Recommended Operating Conditions

Parameter	Symbol	Min	Max	Unit
High-Side Floating Supply Absolute Voltage	V_B	$V_S + 10$	$V_S + 20$	V
High-Side Floating Supply Offset Voltage	V_S	(Note 6)	500	V
High-Side Floating Supply Offset Voltage	V_S	(Note 6)	600	V
High-Side Floating Output Voltage	V_{HO}	V_S	V_B	V
Low-Side Fixed Supply Voltage	V_{CC}	10	20	V
Low-Side Output Voltage	V_{LO}	0	V_{CC}	V
Logic Supply Voltage	V_{DD}	$V_{SS} + 3$	$V_{SS} + 20$	V
Logic Supply Offset Voltage	V_{SS}	-5 (Note 7)	5	V
Logic Input Voltage (HIN, LIN, and SD)	V_{IN}	V_{SS}	V_{DD}	V
Ambient Temperature	T_A	-40	+125	$^\circ\text{C}$

Notes: 6. Logic operation for $V_S = -4\text{V}$ to +500V.

7. When $V_{DD} < 5\text{V}$, the minimum V_{SS} offset is limited to $-V_{DD}$.

DC Electrical Characteristics (V_{BIAS} (V_{CC} , V_{BS} , V_{DD}) = 15V, V_{SS} = COM, @ T_A = +25°C unless otherwise specified.) (Note 8)

Parameter	Symbol	Min	Typ	Max	Unit	Conditions
Logic "1" Input Voltage (Note 9)	V_{IH}	9.5	—	—	V	—
Logic "0" Input Voltage (Note 9)	V_{IL}	—	—	6.0	V	—
High Level Output Voltage, $V_{BIAS} - V_O$	V_{OH}	—	—	1.4	V	$I_O = 0\text{mA}$
Low Level Output Voltage, V_O	V_{OL}	—	—	0.15	V	$I_O = 20\text{mA}$
Offset Supply Leakage Current	I_{LK}	—	—	50	μA	$V_B = V_S = 500\text{V}/600\text{V}$
Quiescent V_{BS} Supply Current	I_{BSQ}	—	55	230	μA	$V_{IN} = 0\text{V}$ or V_{DD}
Quiescent V_{CC} Supply Current	I_{CCQ}	—	56	340	μA	$V_{IN} = 0\text{V}$ or V_{DD}
Quiescent V_{DD} Supply Current	I_{DDQ}	—	0.6	30	μA	$V_{IN} = 0\text{V}$ or V_{DD}
Logic "1" Input Bias Current	I_{IN+}	—	20	40	μA	$V_{IN} = V_{DD}$
Logic "0" Input Bias Current	I_{IN-}	—	—	5.0	μA	$V_{IN} = 0\text{V}$
V_{BS} Supply Undervoltage Positive Going Threshold	V_{BSUV+}	7.5	8.6	9.7	V	—
V_{BS} Supply Undervoltage Negative Going Threshold	V_{BSUV-}	7.0	8.2	9.4	V	—
V_{CC} Supply Undervoltage Positive Going Threshold	V_{CCUV+}	7.4	8.5	9.6	V	—
V_{CC} Supply Undervoltage Negative Going Threshold	V_{CCUV-}	7.0	8.2	9.4	V	—
Output High Short Circuit Pulsed Current	I_{O+}	2.0	2.5	—	A	$V_O = 0\text{V}$, $V_{IN} = V_{DD}$, $PW \leq 10\mu\text{s}$
Output Low Short Circuit Pulsed Current	I_{O-}	2.0	2.5	—	A	$V_O = 15\text{V}$, $V_{IN} = 0\text{V}$, $PW \leq 10\mu\text{s}$

- Note:
- The V_{IN} and I_{IN} parameters are referenced to V_{SS} and are applicable to all three logic input pins: HIN, LIN, and SD. The V_O and I_O parameters are referenced to COM and are applicable to the respective output pins: HO and LO.
 - For optimal operation, it is recommended that the input pulses (HIN and LIN) should have a minimum amplitude of 9.5V ($V_{DD} = 15\text{V}$) with a minimum pulse width of 200ns.

AC Electrical Characteristics (V_{BIAS} (V_{CC} , V_{BS} , V_{DD}) = 15V, $C_L = 1000\text{pF}$, $V_{SS} = \text{COM}$, @ $T_A = +25^\circ\text{C}$, unless otherwise specified.)

Parameter	Symbol	Min	Typ	Max	Unit	Conditions
Turn-On Propagation Delay	t_{ON}	—	105	150	ns	$V_S = 0\text{V}$
Turn-Off Propagation Delay	t_{OFF}	—	94	125	ns	$V_S = 500\text{V}/600\text{V}$
Shut Down Propagation Delay	t_{SD}	—	70	140	ns	$V_S = 500\text{V}/600\text{V}$
Turn-On Rise Time	t_r	—	15	35	ns	—
Turn-Off Fall Time	t_f	—	13	25	ns	—
Delay Matching	DGD2110	t_{DM}	—	—	10	—
Delay Matching	DGD2113	t_{DM}	—	—	20	—

Timing Waveforms

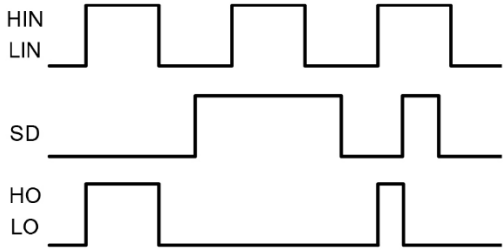

Figure 1. Input / Output Timing Diagram

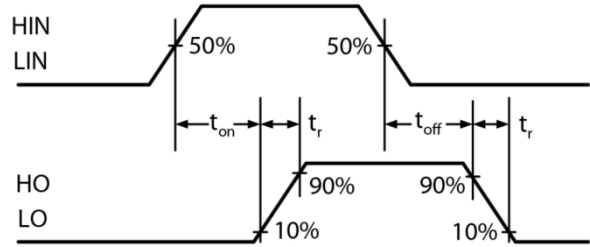

Figure 2. Switching Time Waveform Definitions

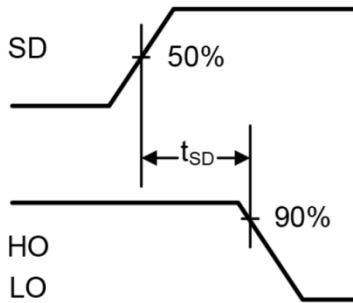

Figure 3. Shutdown Waveform Definitions

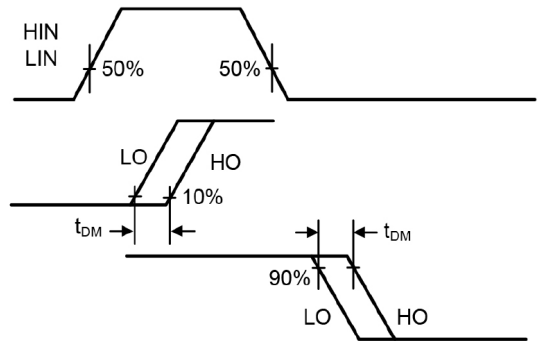

Figure 4. Delay Matching Waveform Definitions

Typical Performance Characteristics ($V_{CC}=15V$, $@T_A = +25^\circ C$, unless otherwise specified.)

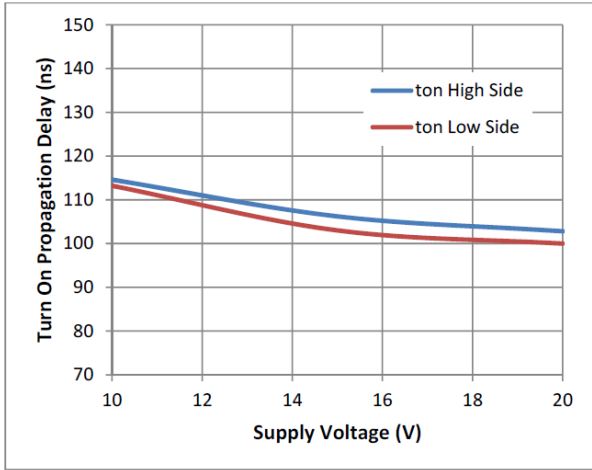

Figure 5. Turn-on Propagation Delay vs. Supply Voltage

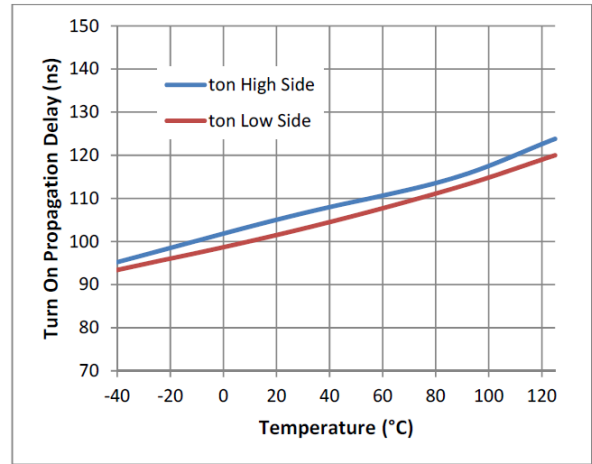

Figure 6. Turn-on Propagation Delay vs. Temperature

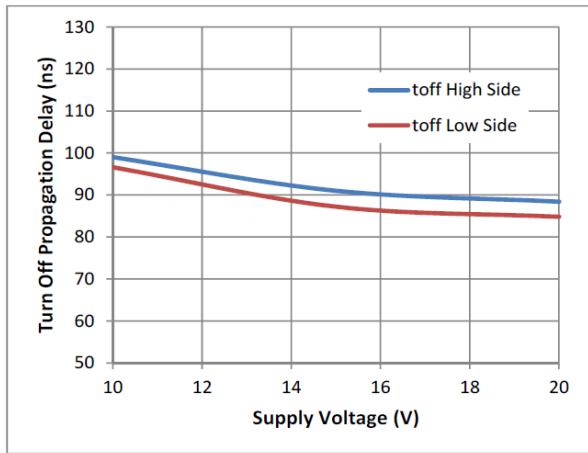

Figure 7. Turn-off Propagation Delay vs. Supply Voltage

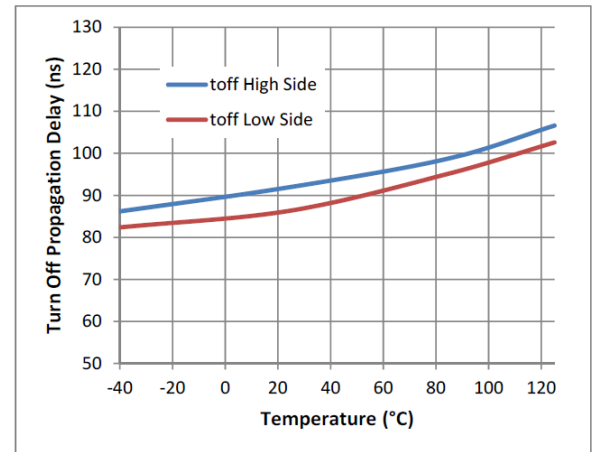

Figure 8. Turn-off Propagation Delay vs. Temperature

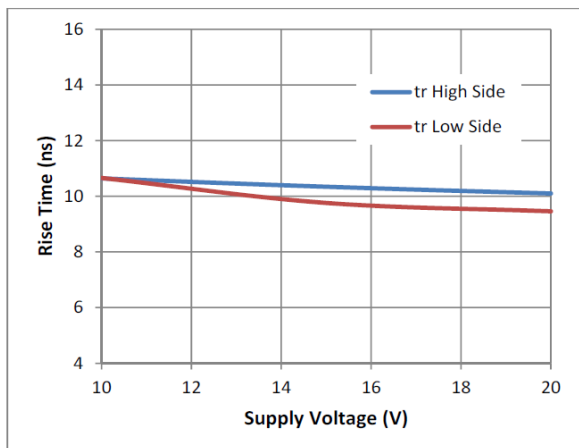

Figure 9. Rise Time vs. Supply Voltage

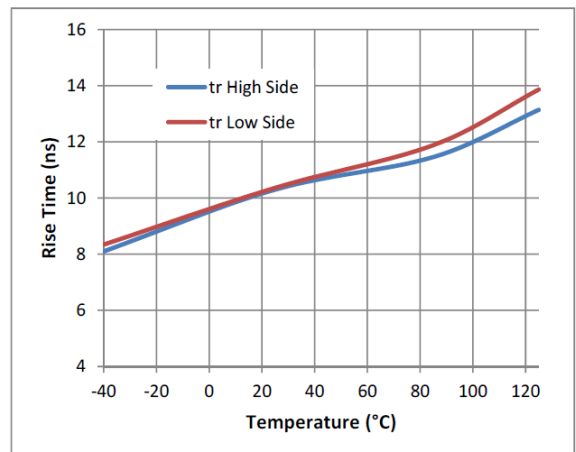

Figure 10. Rise Time vs. Temperature

Typical Performance Characteristics (continued)

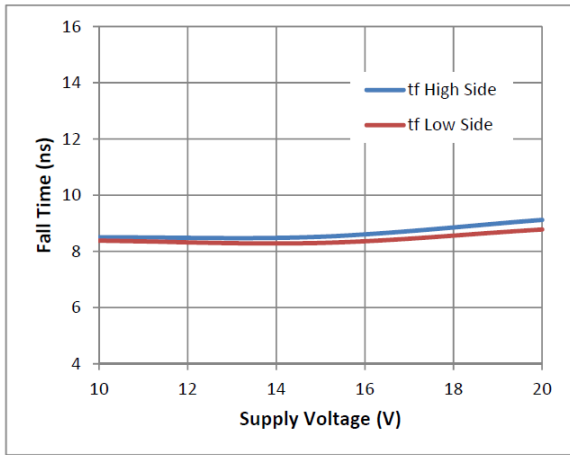

Figure 11. Fall Time vs. Supply Voltage

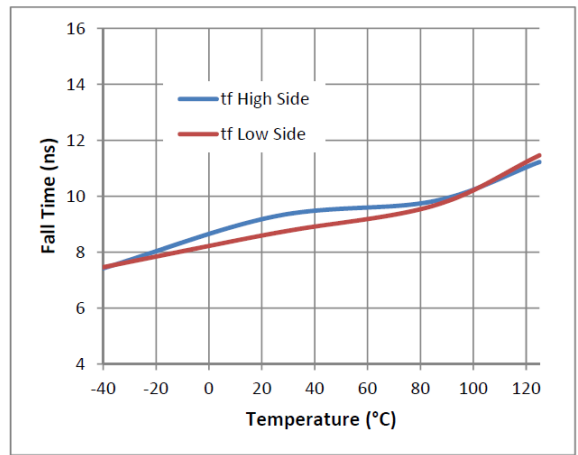

Figure 12. Fall Time vs. Temperature

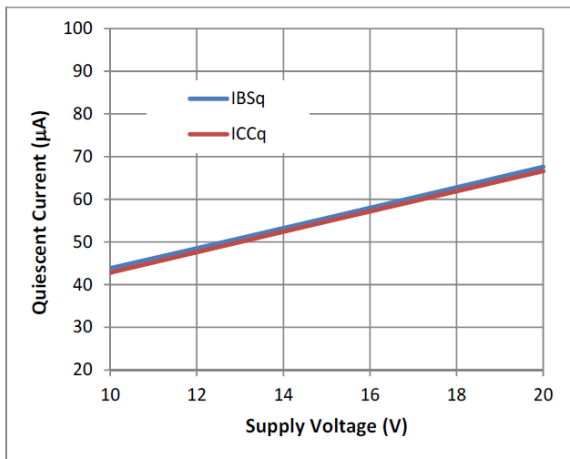

Figure 13. Quiescent Current vs. Supply Voltage

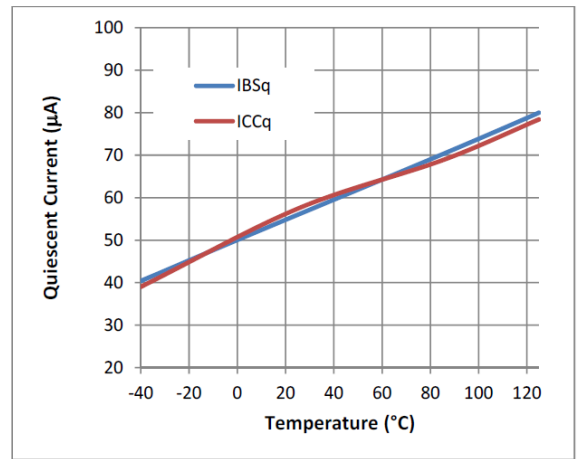

Figure 14. Quiescent Current vs. Temperature

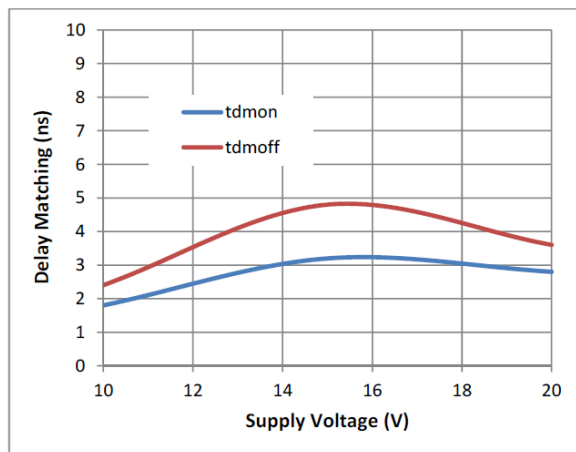

Figure 15. Delay Matching vs. Supply Voltage

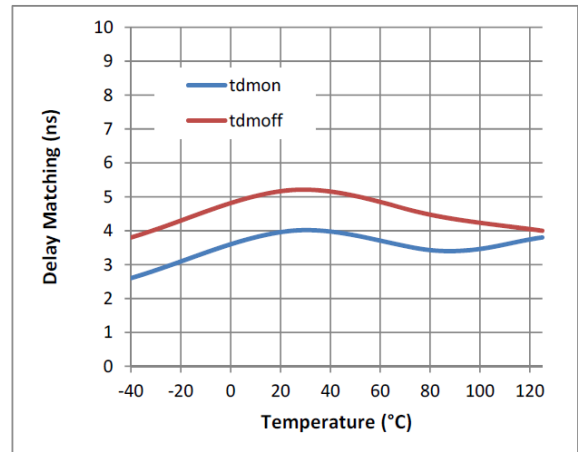

Figure 16. Delay Matching vs. Temperature

Typical Performance Characteristics (cont.)

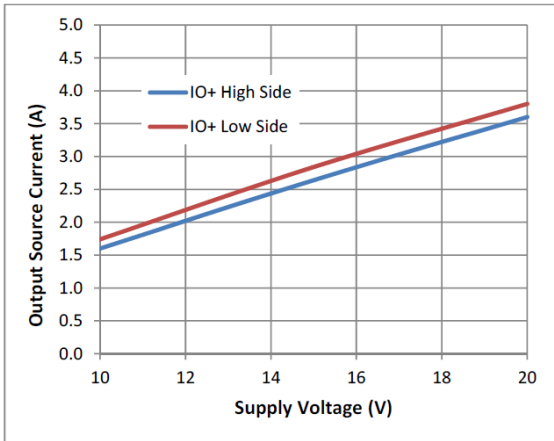

Figure 17. Output Source Current vs. Supply Voltage

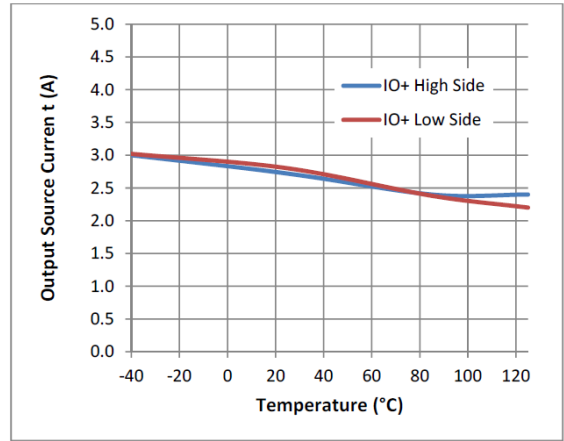

Figure 18. Output Source Current vs. Temperature

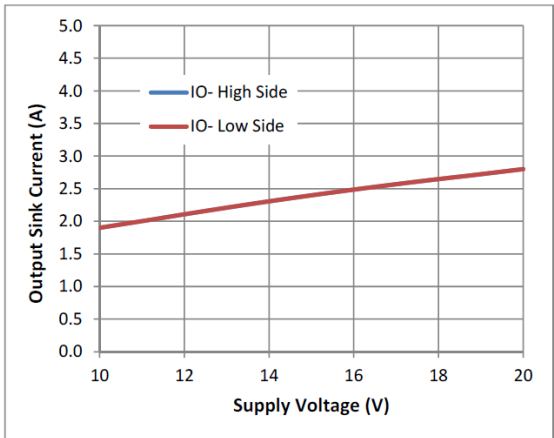

Figure 19. Output Sink Current vs. Supply Voltage

Note: graphs overlap one another

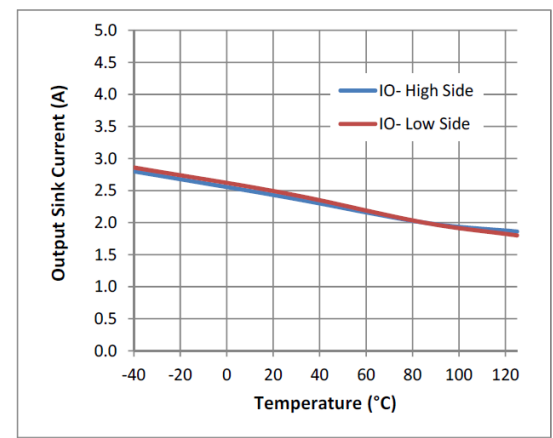

Figure 20. Output Sink Current vs. Temperature

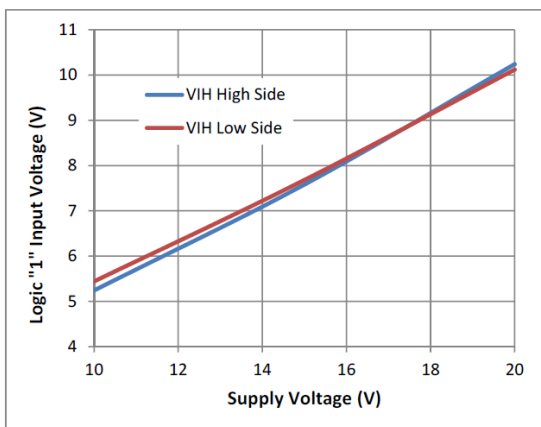

Figure 21. Logic 1 Input Voltage vs. Supply Voltage

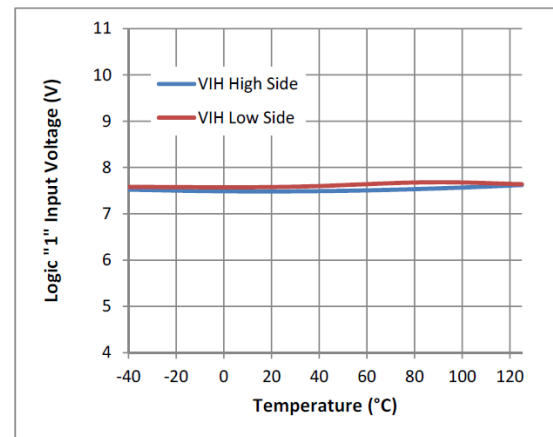

Figure 22. Logic 1 Input Voltage vs. Temperature

Typical Performance Characteristics (cont.)

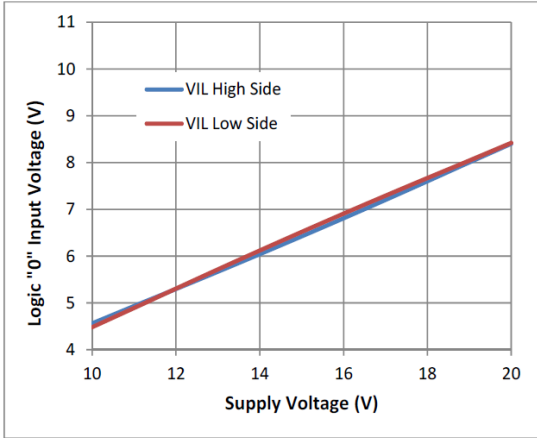

Figure 23. Logic 0 Input Voltage vs. Supply Voltage

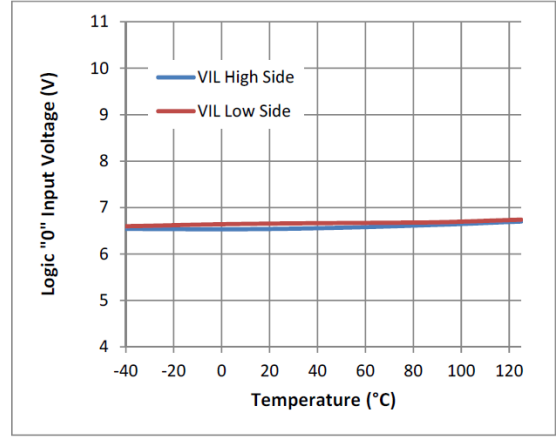

Figure 24. Logic 0 Input Voltage vs. Temperature

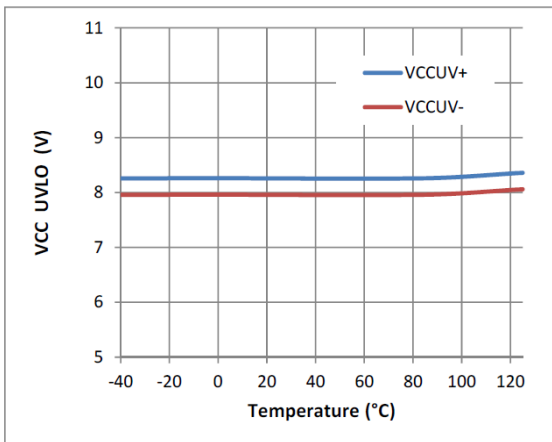

Figure 25. V_{CC} UVLO vs. Temperature

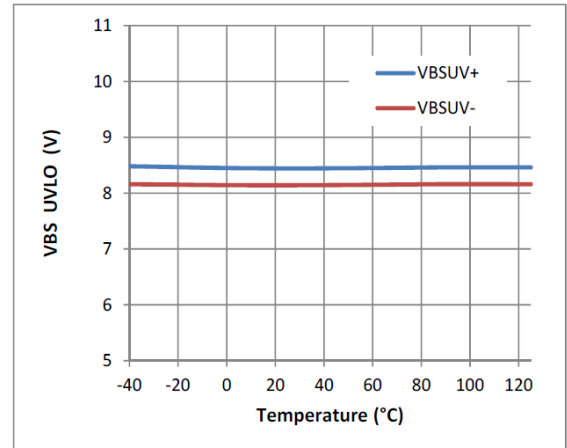

Figure 26. V_{BS} UVLO vs. Temperature

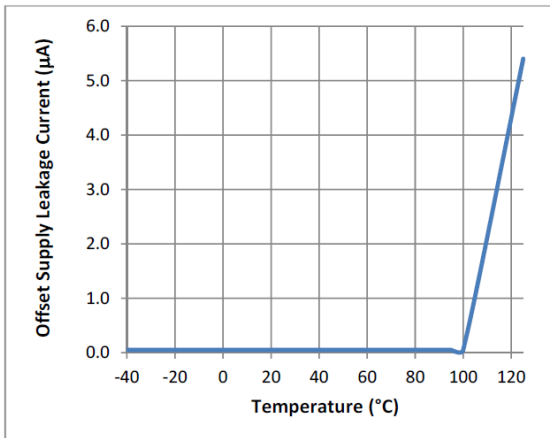

Figure 27. Offset Supply Leakage Current vs. Temperature

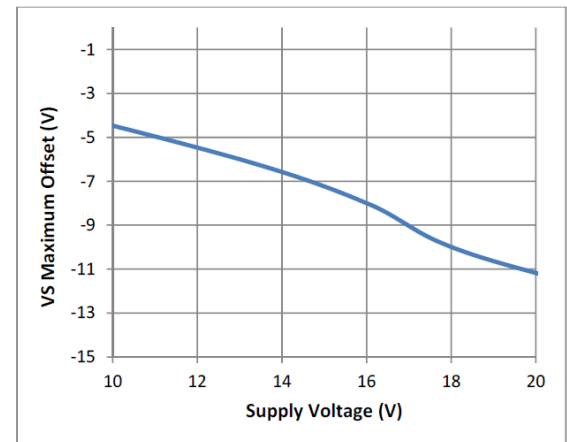

Figure 28. V_S Maximum Offset vs. Supply Voltage

Typical Performance Characteristics (cont.)

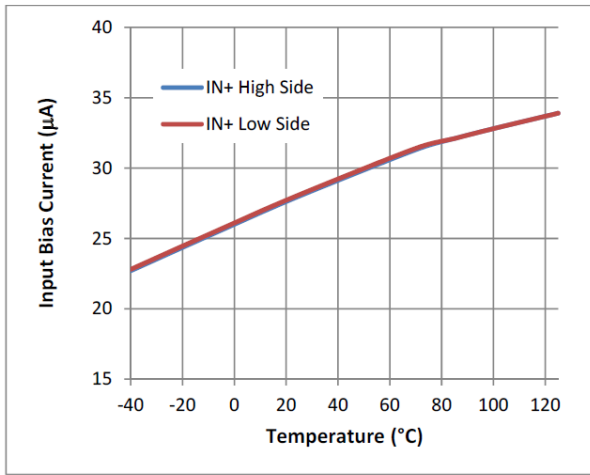

Figure 29. Input Bias Current vs. Temperature

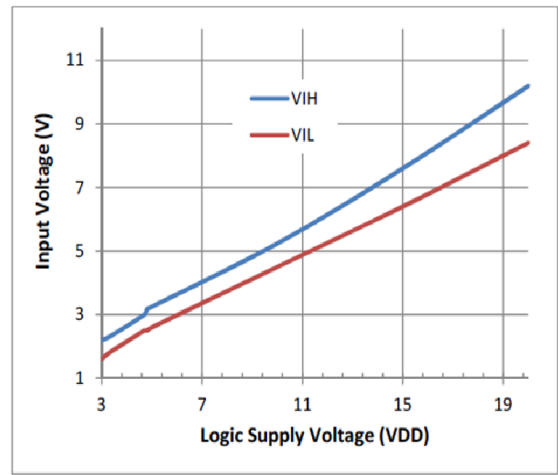

Figure 30. Input Voltage vs. Logic Supply Voltage

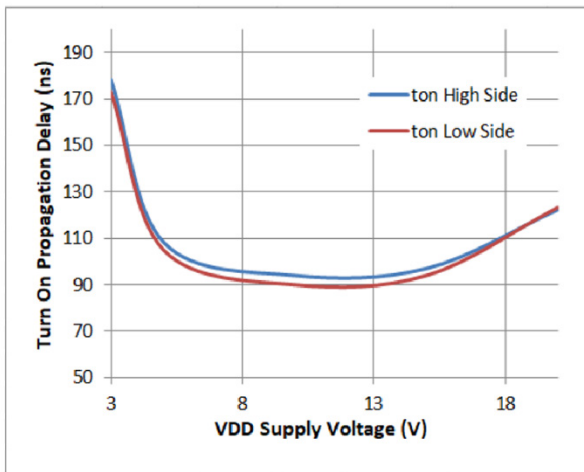

Figure 31. Turn-On Propagation Delay vs. Logic Supply Voltage

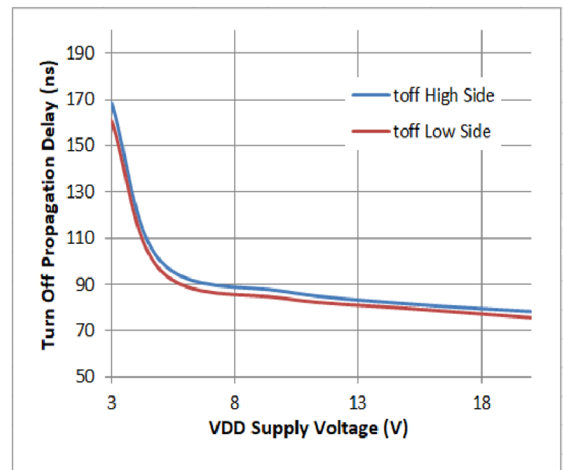

Figure 32. Turn-Off Propagation Delay vs. Logic Supply Voltage

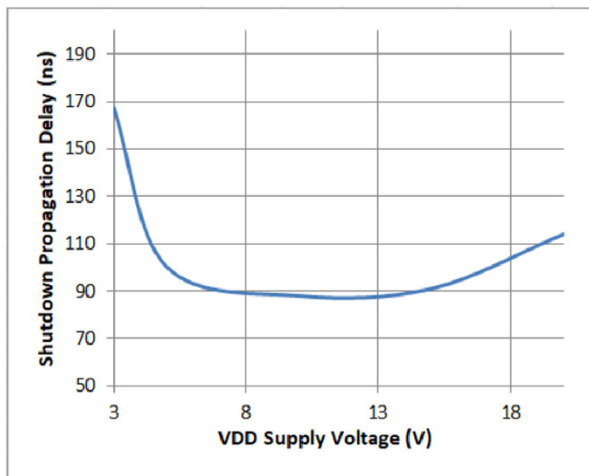
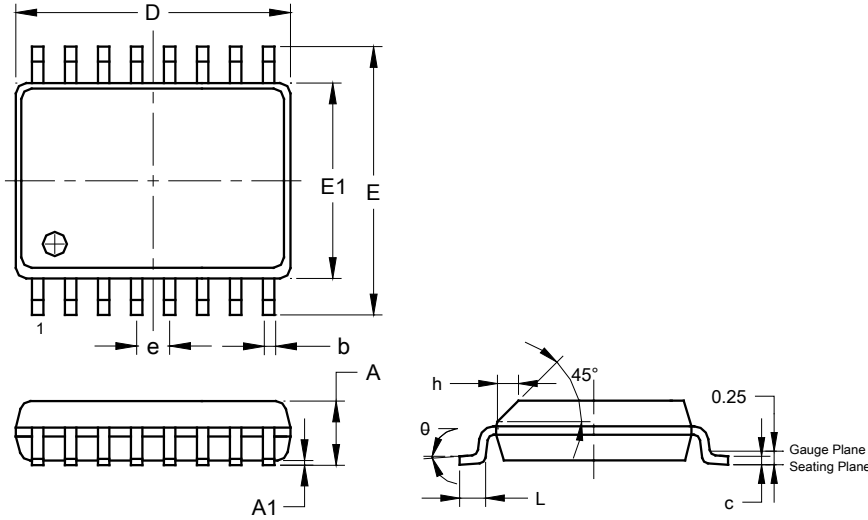

Figure 33. Shutdown Propagation Delay vs. Logic Supply Voltage

Package Outline Dimensions

Please see <http://www.diodes.com/package-outlines.html> for the latest version.

SO-16 (Type TH)



SO-16 (Type TH)			
Dim	Min	Max	Typ
A	2.36	2.64	--
A1	0.10	0.30	--
b	0.33	0.51	--
c	0.229	0.318	--
D	10.11	10.46	10.29
E	10.01	10.64	10.33
E1	7.42	7.59	7.52
e	--	--	1.27
h	--	--	0.48
L	0.41	1.27	--
theta	0°	8°	--
All Dimensions in mm			

Suggested Pad Layout

Please see <http://www.diodes.com/package-outlines.html> for the latest version.

SO-16 (Type TH)

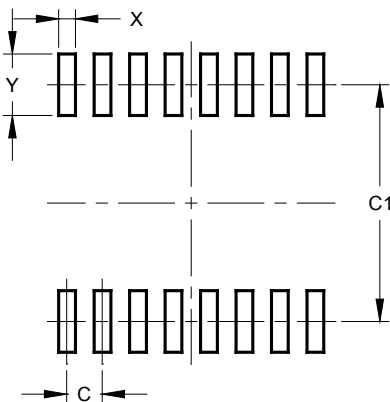

Dimensions	Value (in mm)
C	1.27
C1	8.46
X	0.60
Y	2.20

Note: For high voltage applications, the appropriate industry sector guidelines should be considered with regards to creepage and clearance distances between device Terminals and PCB tracking.

IMPORTANT NOTICE

DIODES INCORPORATED MAKES NO WARRANTY OF ANY KIND, EXPRESS OR IMPLIED, WITH REGARDS TO THIS DOCUMENT, INCLUDING, BUT NOT LIMITED TO, THE IMPLIED WARRANTIES OF MERCHANTABILITY AND FITNESS FOR A PARTICULAR PURPOSE (AND THEIR EQUIVALENTS UNDER THE LAWS OF ANY JURISDICTION).

Diodes Incorporated and its subsidiaries reserve the right to make modifications, enhancements, improvements, corrections or other changes without further notice to this document and any product described herein. Diodes Incorporated does not assume any liability arising out of the application or use of this document or any product described herein; neither does Diodes Incorporated convey any license under its patent or trademark rights, nor the rights of others. Any Customer or user of this document or products described herein in such applications shall assume all risks of such use and will agree to hold Diodes Incorporated and all the companies whose products are represented on Diodes Incorporated website, harmless against all damages.

Diodes Incorporated does not warrant or accept any liability whatsoever in respect of any products purchased through unauthorized sales channel. Should Customers purchase or use Diodes Incorporated products for any unintended or unauthorized application, Customers shall indemnify and hold Diodes Incorporated and its representatives harmless against all claims, damages, expenses, and attorney fees arising out of, directly or indirectly, any claim of personal injury or death associated with such unintended or unauthorized application.

Products described herein may be covered by one or more United States, international or foreign patents pending. Product names and markings noted herein may also be covered by one or more United States, international or foreign trademarks.

This document is written in English but may be translated into multiple languages for reference. Only the English version of this document is the final and determinative format released by Diodes Incorporated.

LIFE SUPPORT

Diodes Incorporated products are specifically not authorized for use as critical components in life support devices or systems without the express written approval of the Chief Executive Officer of Diodes Incorporated. As used herein:

A. Life support devices or systems are devices or systems which:

1. are intended to implant into the body, or
2. support or sustain life and whose failure to perform when properly used in accordance with instructions for use provided in the labeling can be reasonably expected to result in significant injury to the user.

B. A critical component is any component in a life support device or system whose failure to perform can be reasonably expected to cause the failure of the life support device or to affect its safety or effectiveness.

Customers represent that they have all necessary expertise in the safety and regulatory ramifications of their life support devices or systems, and acknowledge and agree that they are solely responsible for all legal, regulatory and safety-related requirements concerning their products and any use of Diodes Incorporated products in such safety-critical, life support devices or systems, notwithstanding any devices- or systems-related information or support that may be provided by Diodes Incorporated. Further, Customers must fully indemnify Diodes Incorporated and its representatives against any damages arising out of the use of Diodes Incorporated products in such safety-critical, life support devices or systems.

Copyright © 2019, Diodes Incorporated

www.diodes.com