

**Half-Bridge Driver**

**Features**

- Floating channel designed for bootstrap operation
- Fully operational to +600V
- Tolerant to negative transient voltage
- dV/dt immune
- Gate drive supply range from 10 to 20V
- Undervoltage lockout
- 3.3V, 5V and 15V input logic compatible
- Cross-conduction prevention logic
- Internally set dead-time
- High side output in phase with input
- Shut down input turns off both channels
- Matched propagation delay for both channels

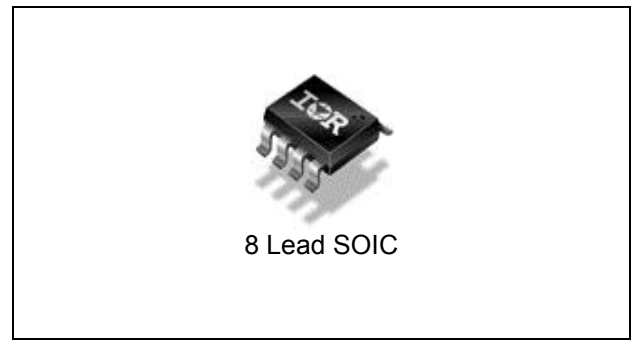
**Description**

The IR25602 is a high voltage, high speed power MOSFET and IGBT driver with dependent high and low side referenced output channels. Proprietary HVIC and latch immune CMOS technologies enable ruggedized monolithic construction. The logic input is compatible with standard CMOS or LSTTL output, down to 3.3V logic. The output drivers feature a high pulse current buffer stage designed for minimum driver cross-conduction. The floating channel can be used to drive an N-channel power MOSFET or IGBT in the high side configuration which operates from 10 to 600 V.

**Product Summary**

$V_{OFFSET}$	600V max.
$I_{O+/-}$	130 mA/ 270 mA
$V_{OUT}$	10 – 20V
Ton/off (typ.)	680 & 150 ns
Dead time (typ.)	520 ns

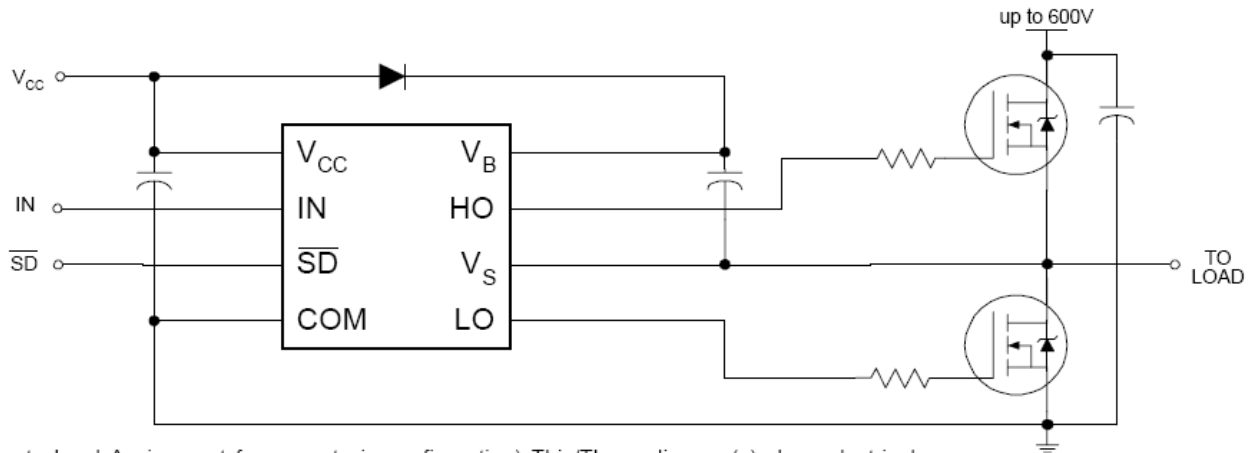
**Package Options**



**Ordering Information**

Base Part Number	Package Type	Standard Pack		Orderable Part Number
		Form	Quantity	
IR25602SPBF	SO8N	Tube	95	IR25602SPBF
IR25602SPBF	SO8N	Tape and Reel	2500	IR25602STRPBF

## Typical Connection Diagram



(Refer to Lead Assignment for correct pin configuration) This/These diagram(s) show electrical connections only. Please refer to our Application Notes and DesignTips for proper circuit board layout.

## Absolute Maximum Ratings

Absolute maximum ratings indicate sustained limits beyond which damage to the device may occur. All voltage parameters are absolute voltages referenced to COM. The thermal resistance and power dissipation ratings are measured under board mounted and still air conditions.

Symbol	Definition	Min.	Max.	Units
$V_B$	High side floating absolute voltage	-0.3	625	V
$V_S$	High side floating supply offset voltage	$V_B - 25$	$V_B + 0.3$	
$V_{HO}$	High side floating output voltage	$V_S - 0.3$	$V_B + 0.3$	
$V_{CC}$	Low side and logic fixed supply voltage	-0.3	25	
$V_{LO}$	Low side output voltage	-0.3	$V_{CC} + 0.3$	
$V_{IN}$	Logic input voltage (IN & $\overline{SD}$ )	-0.3	$V_{CC} + 0.3$	
dVs/dt	Allowable offset supply voltage transient	—	50	V/ns
$P_D$	Package power dissipation @ $T_A \leq +25^\circ\text{C}$	—	0.625	W
$R_{thJA}$	Thermal resistance, junction to ambient	—	200	$^\circ\text{C/W}$
$T_J$	Junction temperature	—	150	$^\circ\text{C}$
$T_S$	Storage temperature	-55	150	
$T_L$	Lead temperature (soldering, 10 seconds)	—	300	

## Recommended Operating Conditions

For proper operation the device should be used within the recommended conditions. The  $V_S$  offset rating is tested with all supplies biased at 15V differential.

Symbol	Definition	Min.	Max.	Units
$V_B$	High side floating supply absolute voltage	$V_S + 10$	$V_S + 20$	V
$V_S$	High side floating supply offset voltage	+	600	
$V_{HO}$	High side floating output voltage	$V_S$	$V_B$	
$V_{CC}$	Low side and logic fixed supply voltage	10	20	
$V_{LO}$	Low side output voltage	0	$V_{CC}$	
$V_{IN}$	Logic input voltage (IN & $\overline{SD}$ )	0	$V_{CC}$	
$T_A$	Ambient temperature	-40	125	$^\circ\text{C}$

+Logic operational for  $V_S$  of -5 to +600V. Logic state held for  $V_S$  of -5V to - $V_{BS}$ . (Please refer to Design Tip DT97-3 for more details).

## Dynamic Electrical Characteristics

$V_{BIAS}$  ( $V_{CC}$ ,  $V_{BS}$ ) = 15V,  $C_L$  = 1000 pF and  $T_A$  = 25°C unless otherwise specified.

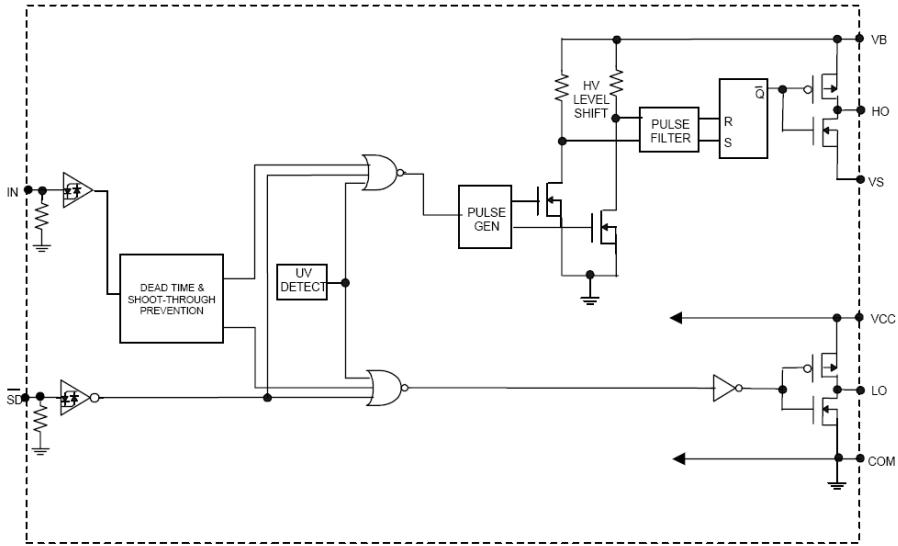
Symbol	Definition	Min.	Typ.	Max.	Units	Test Conditions
$t_{on}$	Turn-on propagation delay	—	680	820	ns	$V_S = 0V$
$t_{off}$	Turn-off propagation delay	—	150	220		$V_S = 600V$
$t_{sd}$	Shutdown propagation delay	—	160	220		
$t_r$	Turn-on rise time	—	100	170		
$t_f$	Turn-off fall time	—	50	90		
DT	Dead time, LS turn-off to HS turn-on & HS turn-on to LS turn-off	400	520	650		
MT	Delay matching, HS & LS turn-on/off	—	—	60		

## Static Electrical Characteristics

$V_{BIAS}$  ( $V_{CC}$ ,  $V_{BS}$ ) = 15V and  $T_A$  = 25°C unless otherwise specified. The  $V_{IN}$ ,  $V_{TH}$  and  $I_{IN}$  parameters are referenced to COM. The  $V_O$  and  $I_O$  parameters are referenced to COM and are applicable to the respective output leads: HO and LO.

Symbol	Definition	Min.	Typ.	Max.	Units	Test Conditions
$V_{IH}$	Logic "1" (HO) & Logic "0" (LO) input voltage	3	—	—	V	$V_{CC} = 10V$ to 20V
$V_{IL}$	Logic "0" (HO) & Logic "1" (LO) input voltage	—	—	0.8		$V_{CC} = 10V$ to 20V
$V_{SD,TH+}$	SD input positive going threshold	3	—	—		$V_{CC} = 10V$ to 20V
$V_{SD,TH-}$	SD input negative going threshold	—	—	0.8		$V_{CC} = 10V$ to 20V
$V_{OH}$	High level output voltage, $V_{BIAS} - V_O$	—	—	100	mV	$I_O = 0A$
$V_{OL}$	Low level output voltage, $V_O$	—	—	100		$I_O = 0A$
$I_{LK}$	Offset supply leakage current	—	—	50	$\mu A$	$V_B = V_S = 600V$
$I_{QBS}$	Quiescent $V_{BS}$ supply current	—	30	55		$V_{IN} = 0V$ or 5V
$I_{QCC}$	Quiescent $V_{CC}$ supply current	—	150	270		$V_{IN} = 0V$ or 5V
$I_{IN+}$	Logic "1" input bias current	—	3	10		$V_{IN} = 5V$
$I_{IN-}$	Logic "0" input bias current	—	—	1		$V_{IN} = 0V$
$V_{CCUV+}$	$V_{CC}$ supply undervoltage positive going threshold	8	8.9	9.8	V	
$V_{CCUV-}$	$V_{CC}$ supply undervoltage negative going threshold	7.4	8.2	9		
$I_{O+}$	Output high short circuit pulsed current	130	210	—	mA	$V_O = 0V$ $PW \leq 10 \mu s$
$I_{O-}$	Output low short circuit pulsed current	270	360	—		$V_O = 15V$ $PW \leq 10 \mu s$

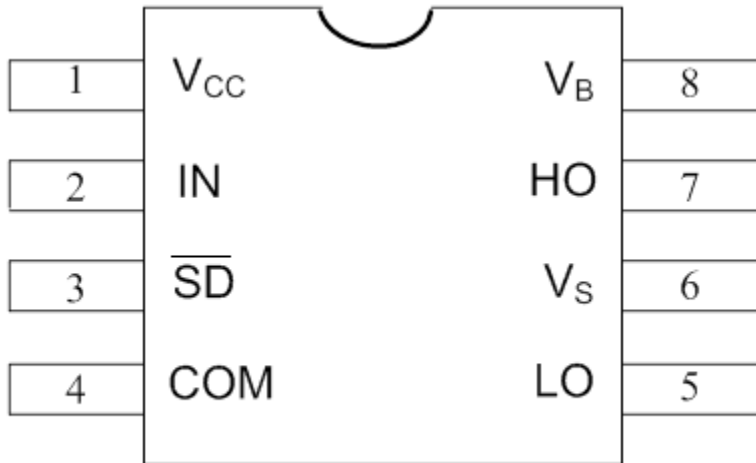
**Functional Block Diagram**



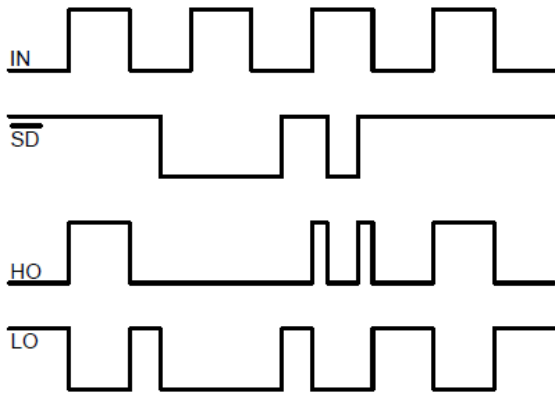
**Lead Definitions**

Symbol	Description
IN	Logic input for high and low side gate driver outputs (HO and LO), in phase with HO
$\overline{SD}$	Logic input for shutdown
$V_B$	High side floating supply
HO	High side gate drive output
$V_S$	High side floating supply return
$V_{CC}$	Low side and logic fixed supply
LO	Low side gate drive output
COM	Low side return

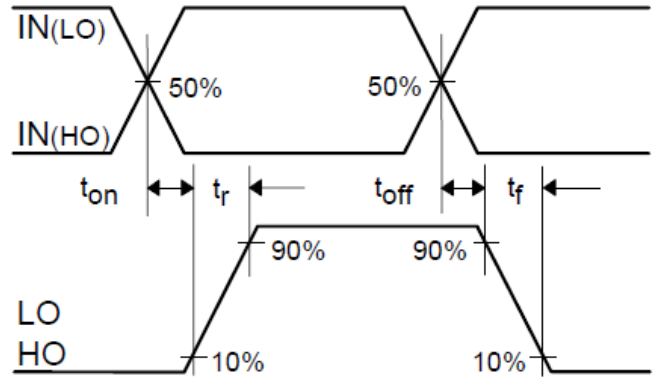
**Lead Assignments**



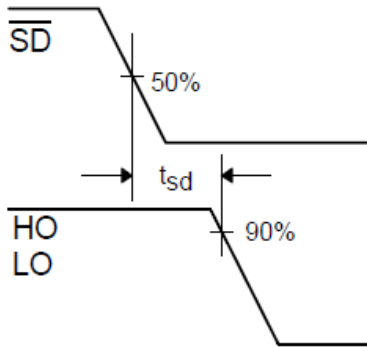
**Application Information and Additional Details**



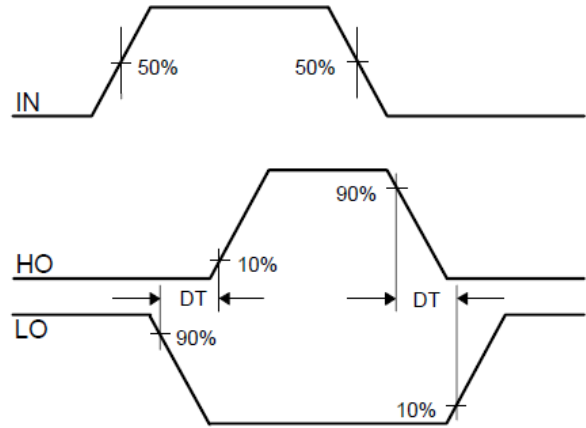
**Figure 1. Input/Output Timing Diagram**



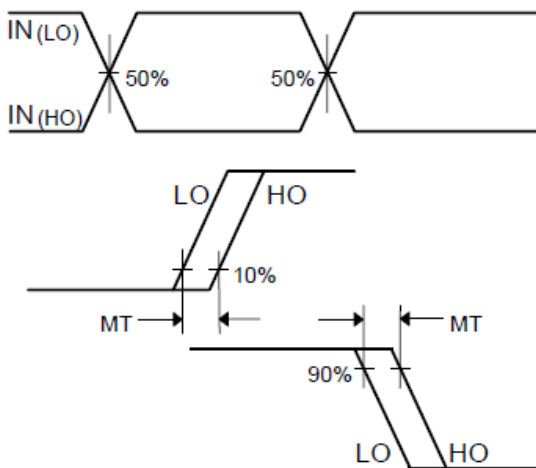
**Figure 2. Switching Time Waveform Definitions**



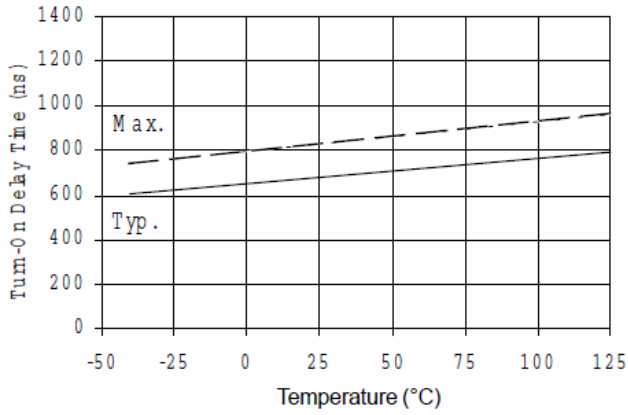
**Figure 3. Shutdown Waveform Definitions**



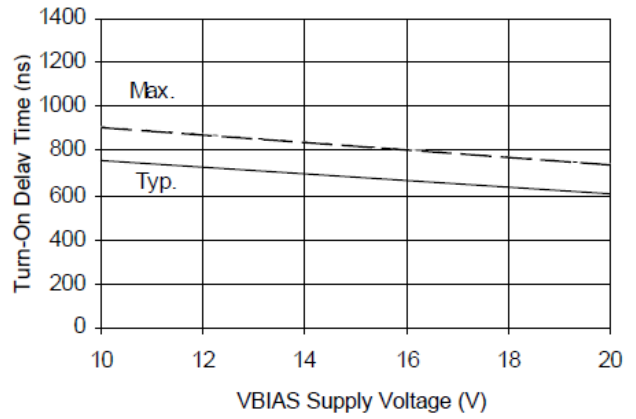
**Figure 4. Deadtime Waveform Definitions**



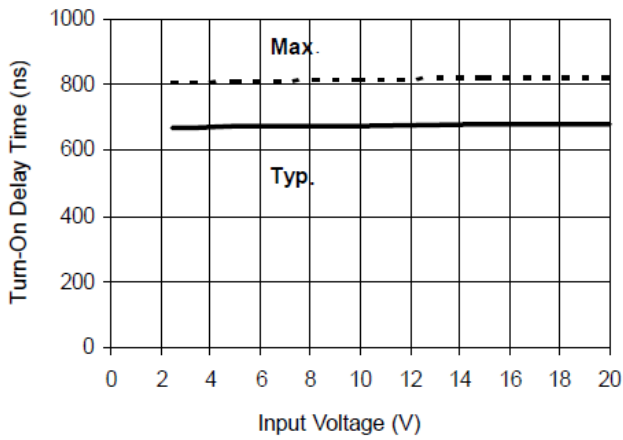
**Figure 5. Delay Matching Waveform Definitions**



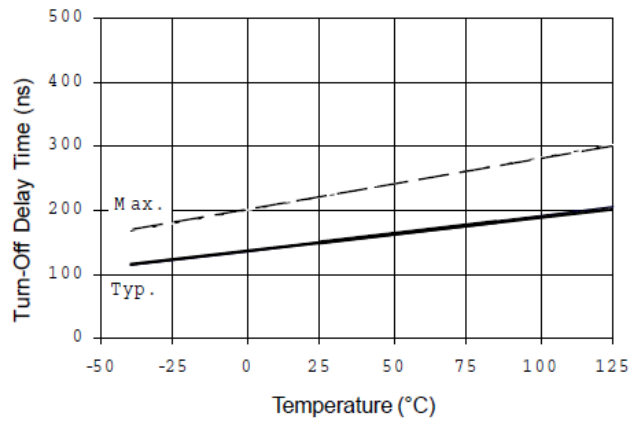
**Figure 6A. Turn-On Time vs Temperature**



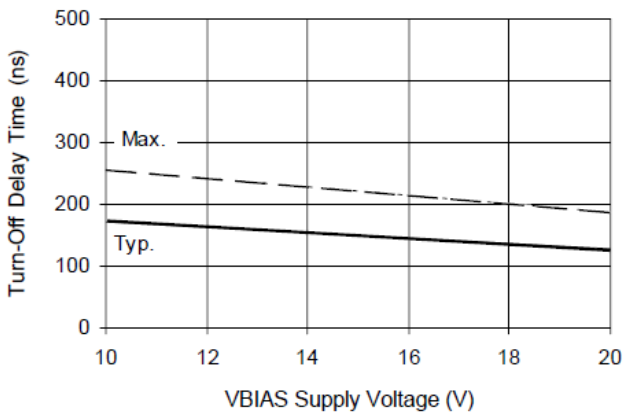
**Figure 6B. Turn-On Time vs Supply Voltage**



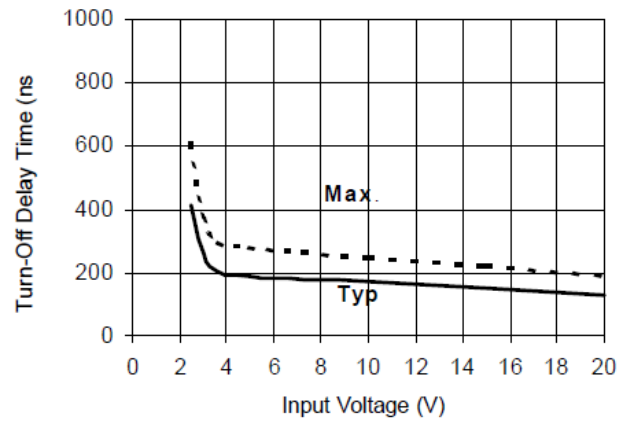
**Figure 6C. Turn-On Time vs Input Voltage**



**Figure 7A. Turn-Off Time vs Temperature**

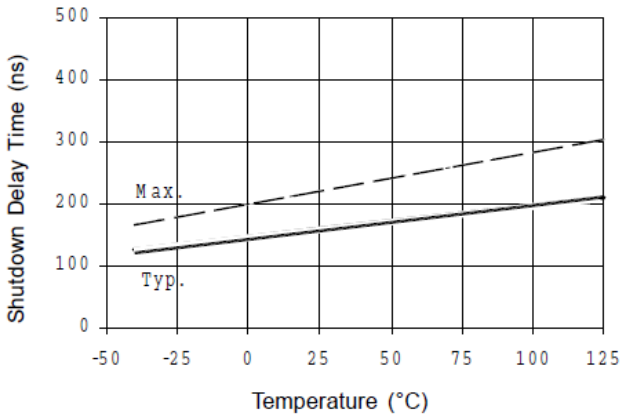


**Figure 7B. Turn-Off Time vs Supply Voltage**

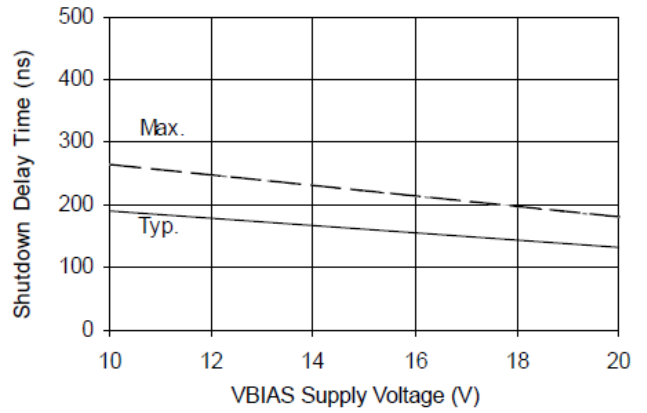


**Figure 7C. Turn-Off Time vs Input Voltage**

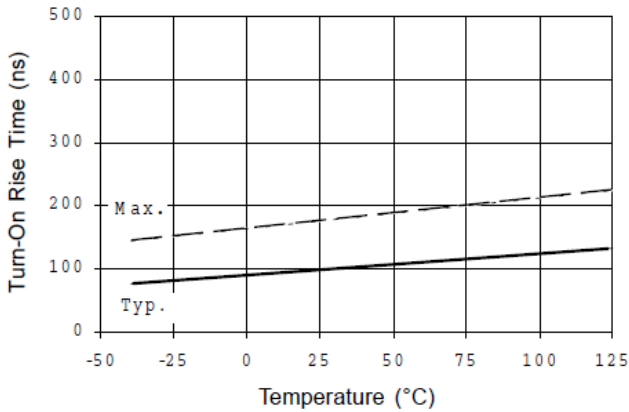




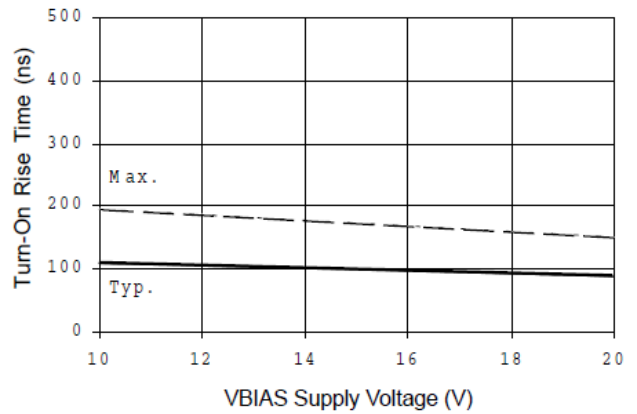
**Figure 8A. Shutdown Time vs Temperature**



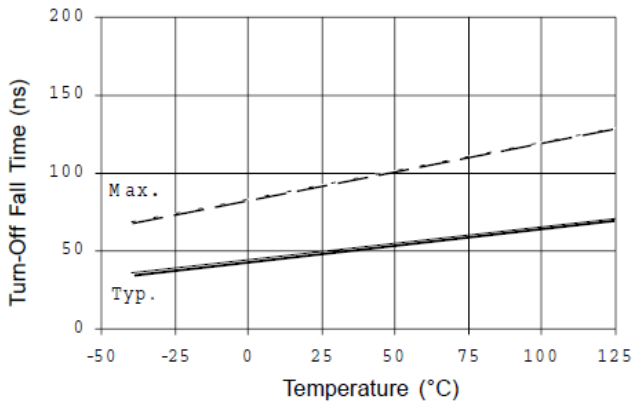
**Figure 8B. Shutdown Time vs Voltage**



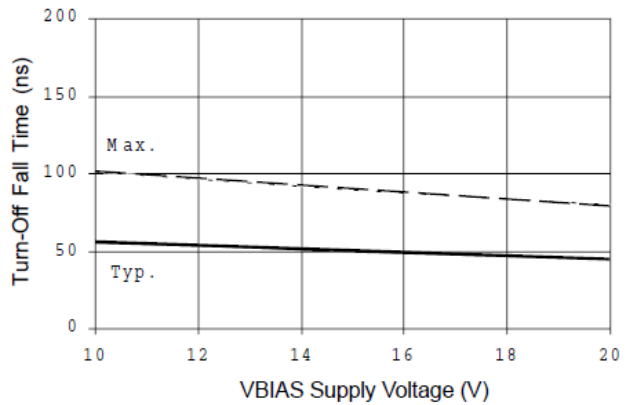
**Figure 9A. Turn-On Rise Time vs Temperature**



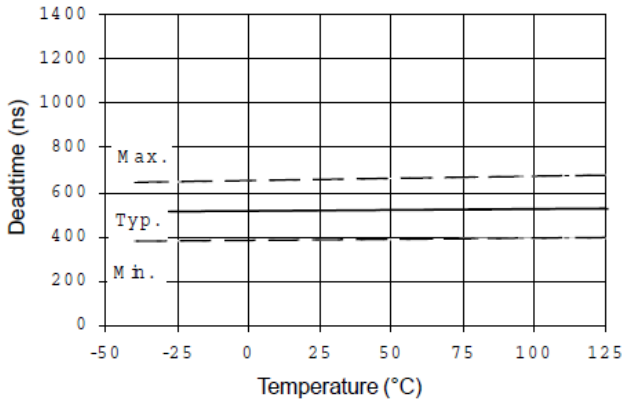
**Figure 9B. Turn-On Rise Time vs Voltage**



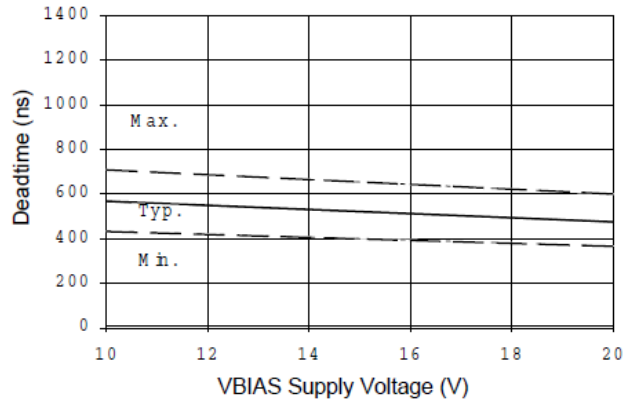
**Figure 10A. Turn-Off Fall Time vs Temperature**



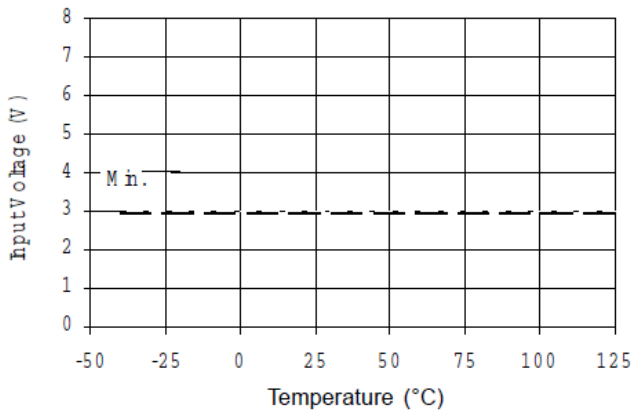
**Figure 10B. Turn-Off Fall Time vs Voltage**



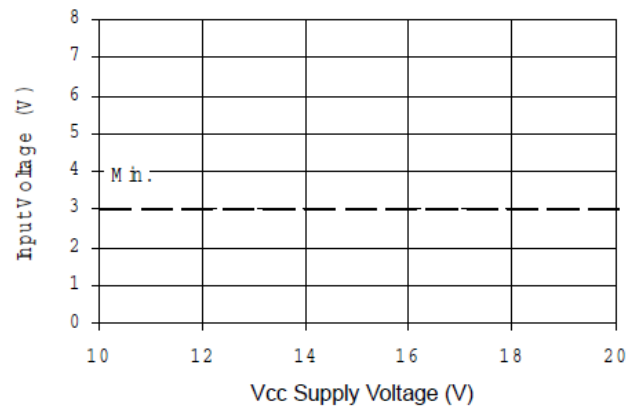
**Figure 11A. Deadtime vs Temperature**



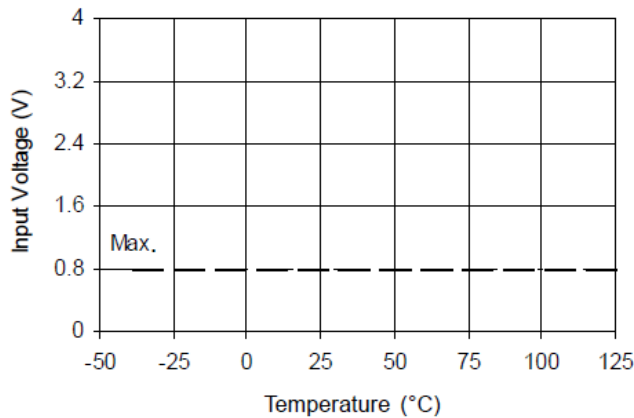
**Figure 11B. Deadtime vs Voltage**



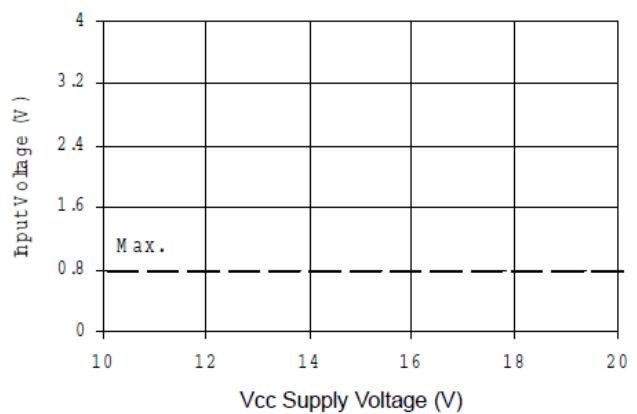
**Figure 12A. Logic "1" (HO) & Logic "0" (LO) & Inactive SD Input Voltage vs Temperature**



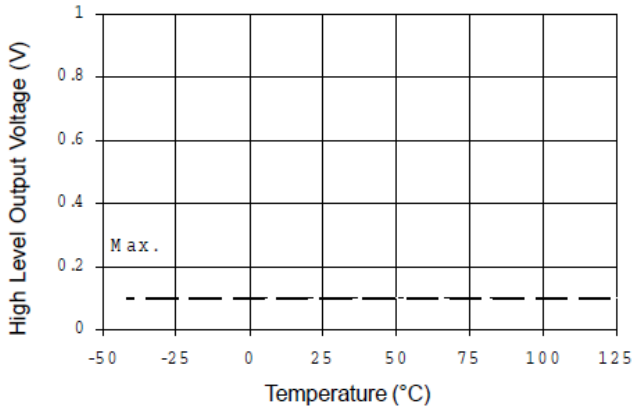
**Figure 12B. Logic "1" (HO) & Logic "0" (LO) & Inactive SD Input Voltage vs Voltage**



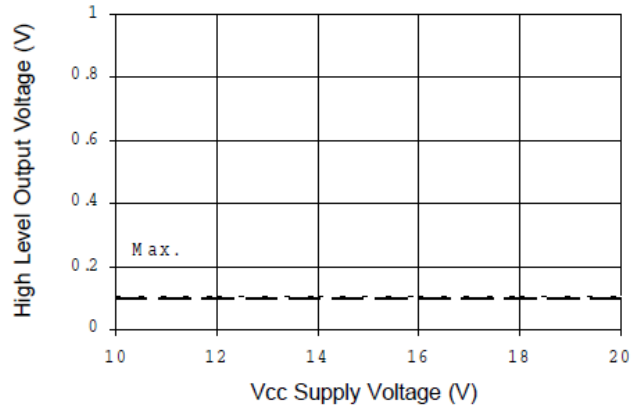
**Figure 13A. Logic "0" (HO) & Logic "1" (LO) & Active SD Input Voltage vs Temperature**



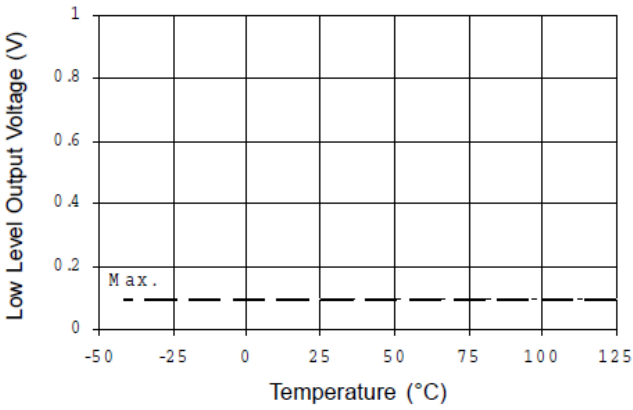
**Figure 13B. Logic "0" (HO) & Logic "1" (LO) & Active SD Input Voltage vs Voltage**



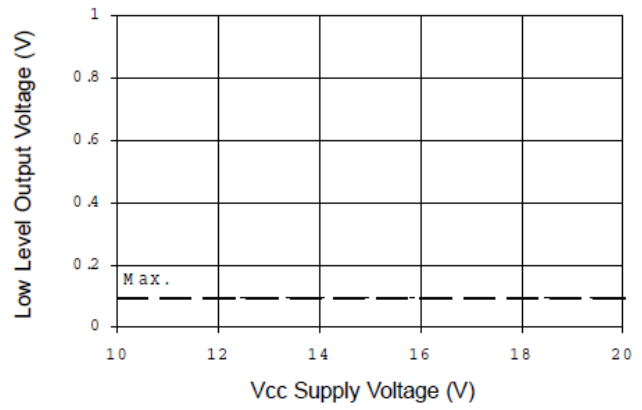
**Figure 14A. High Level Output vs Temperature**



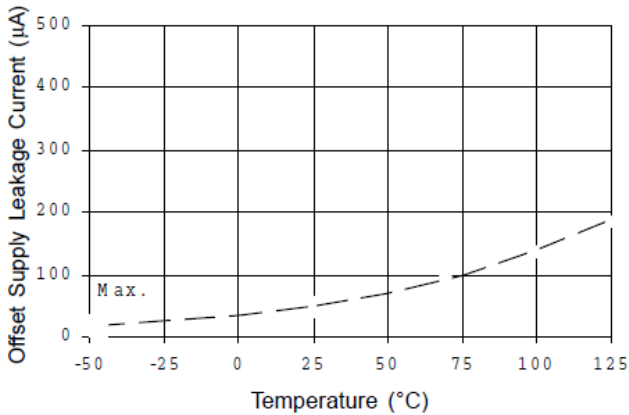
**Figure 14B. High Level Output vs Voltage**



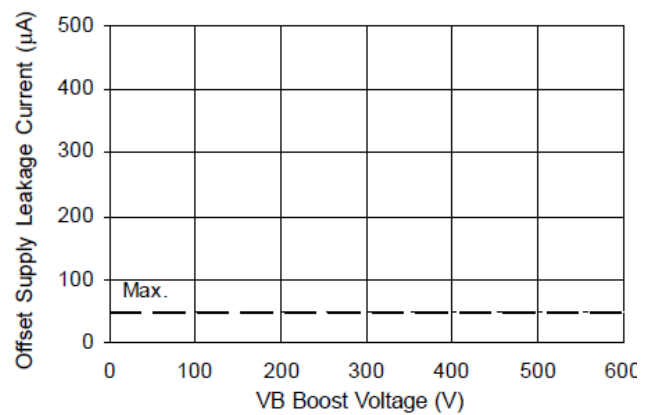
**Figure 15A. Low Level Output vs Temperature**



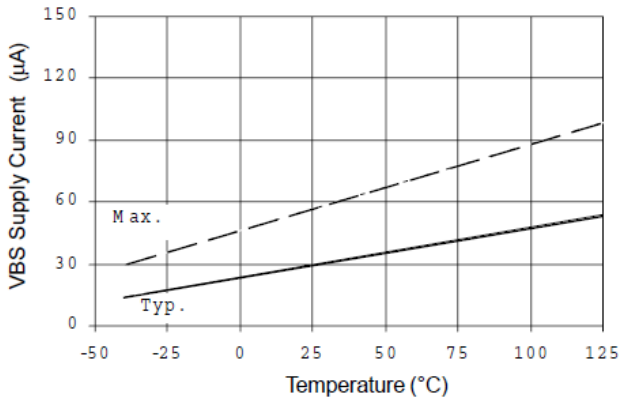
**Figure 15B. Low level Output vs Voltage**



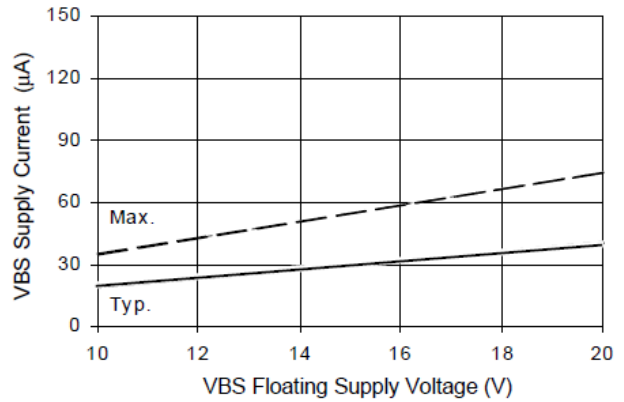
**Figure 16A. Offset Supply Current vs Temperature**



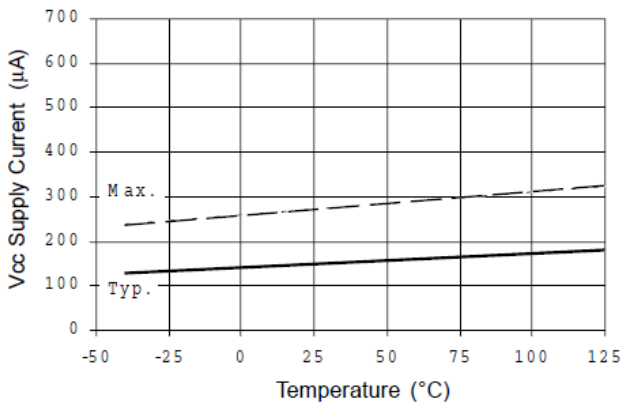
**Figure 16B. Offset Supply Current vs Voltage**



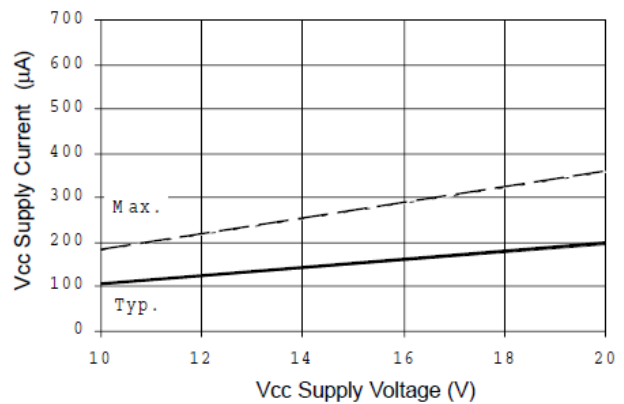
**Figure 17A. V<sub>BS</sub> Supply Current vs Temperature**



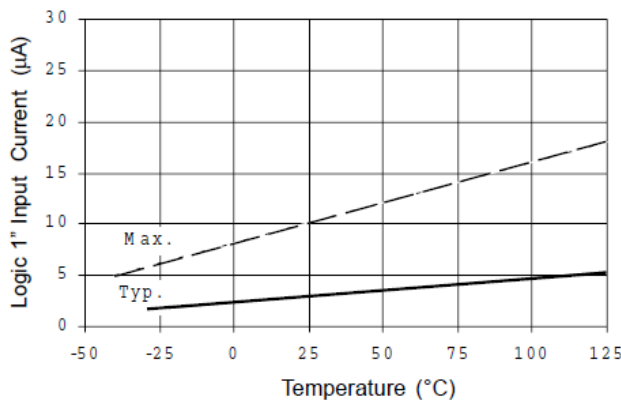
**Figure 17B. V<sub>BS</sub> Supply Current vs Voltage**



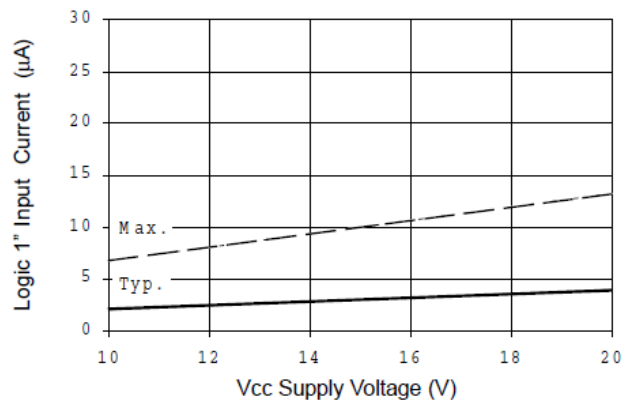
**Figure 18A. V<sub>CC</sub> Supply Current vs Temperature**



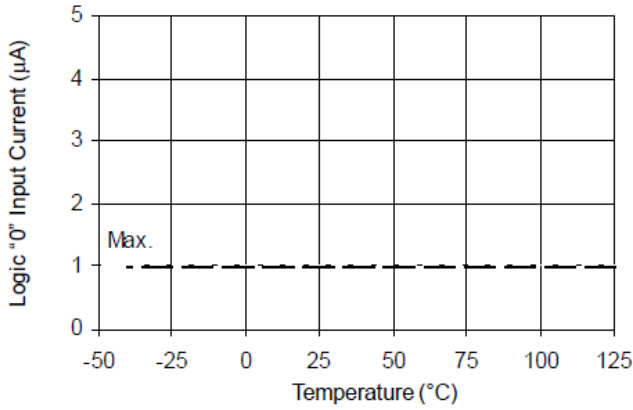
**Figure 18B. V<sub>CC</sub> Supply Current vs Voltage**



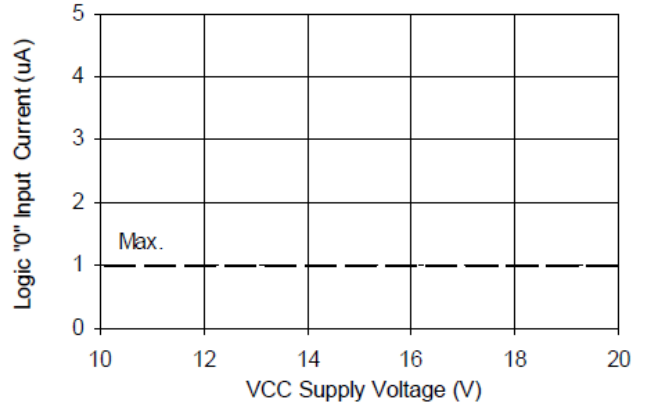
**Figure 19A. Logic "1" Input Current vs Temperature**



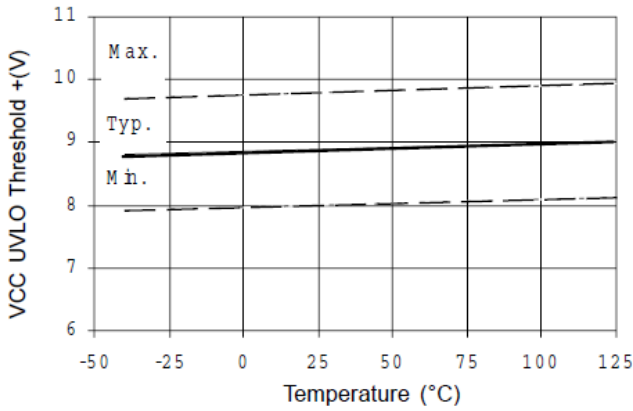
**Figure 19B. Logic "1" Input Current vs Voltage**



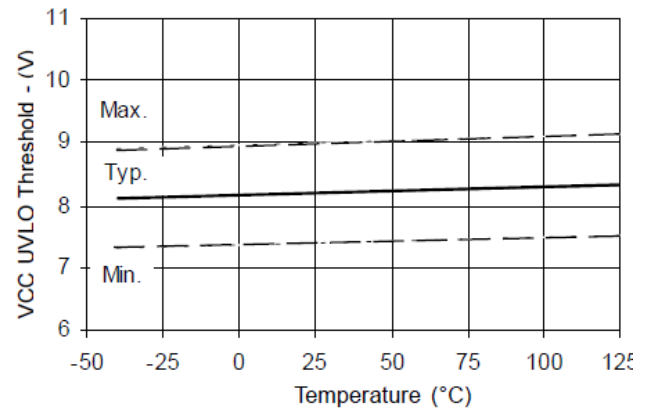
**Figure 20A. Logic "0" Input Current vs Temperature**



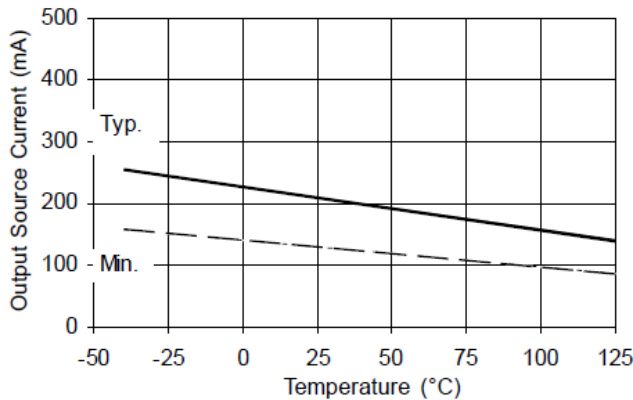
**Figure 20B. Logic "0" Input Current vs Voltage**



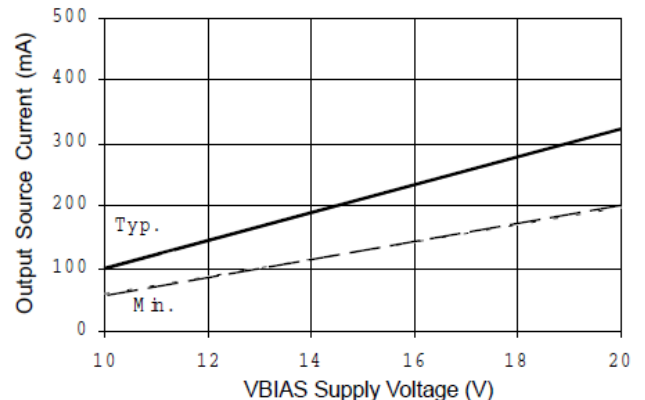
**Figure 21A. Vcc Undervoltage Threshold(+) vs Temperature**



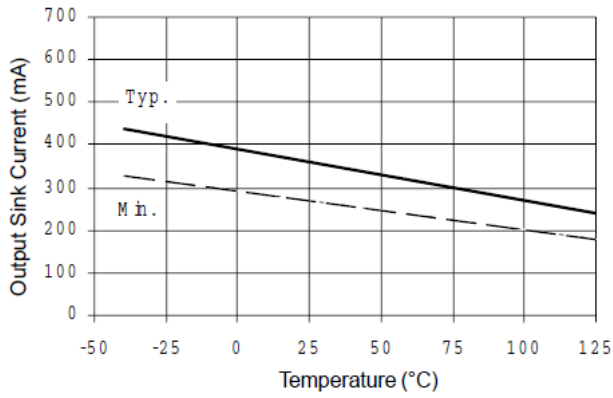
**Figure 21B. Vcc Undervoltage Threshold(-) vs Temperature**



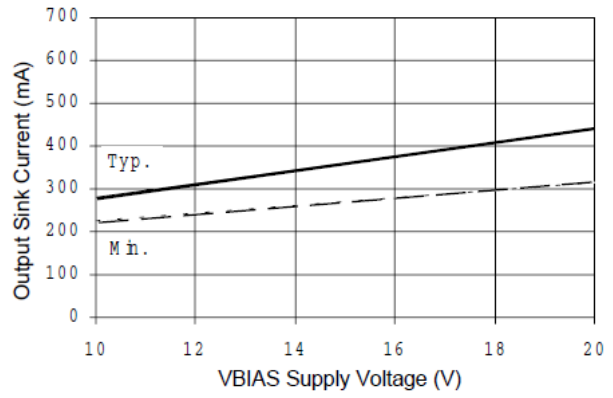
**Figure 22A. Output Source Current vs Temperature**



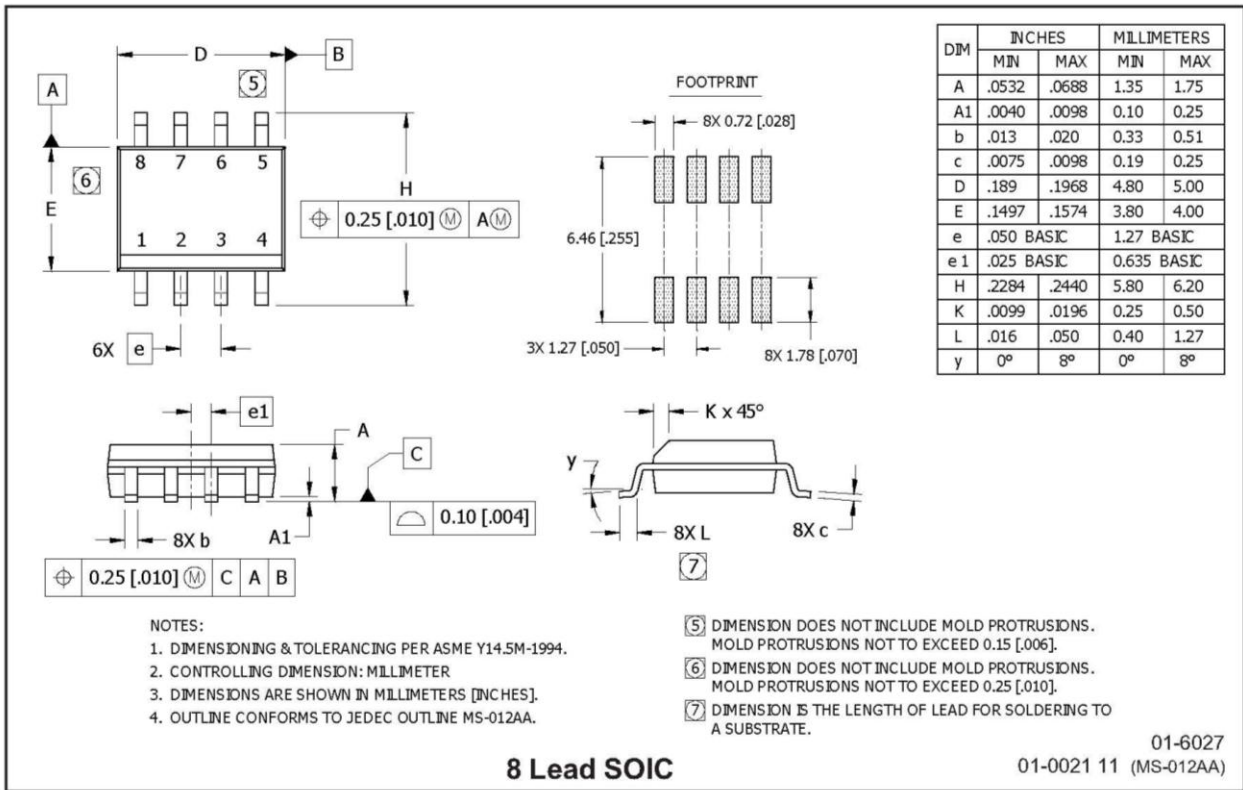
**Figure 22B. Output Source Current vs Voltage**



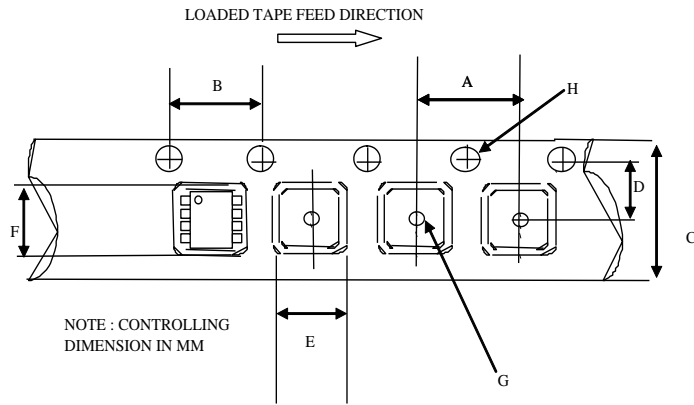
**Figure 23A. Output Sink Current vs Temperature**



**Figure 23B. Output Sink Current vs Voltage**

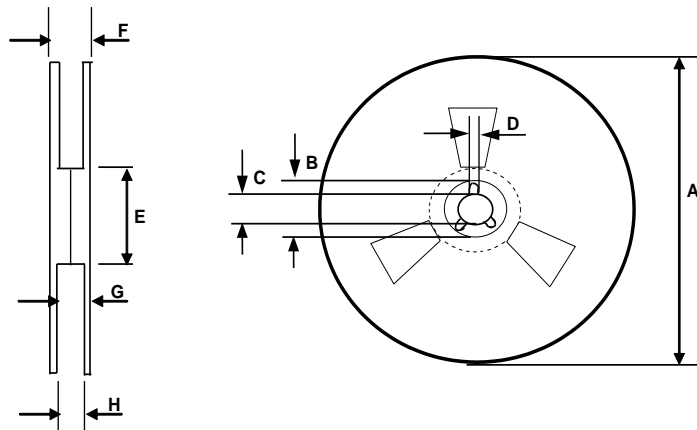
**Package Details**


## Tape and Reel Details



CARRIER TAPE DIMENSION FOR 8SOICN

Code	Metric		Imperial	
	Min	Max	Min	Max
A	7.90	8.10	0.311	0.318
B	3.90	4.10	0.153	0.161
C	11.70	12.30	0.46	0.484
D	5.45	5.55	0.214	0.218
E	6.30	6.50	0.248	0.255
F	5.10	5.30	0.200	0.208
G	1.50	n/a	0.059	n/a
H	1.50	1.60	0.059	0.062

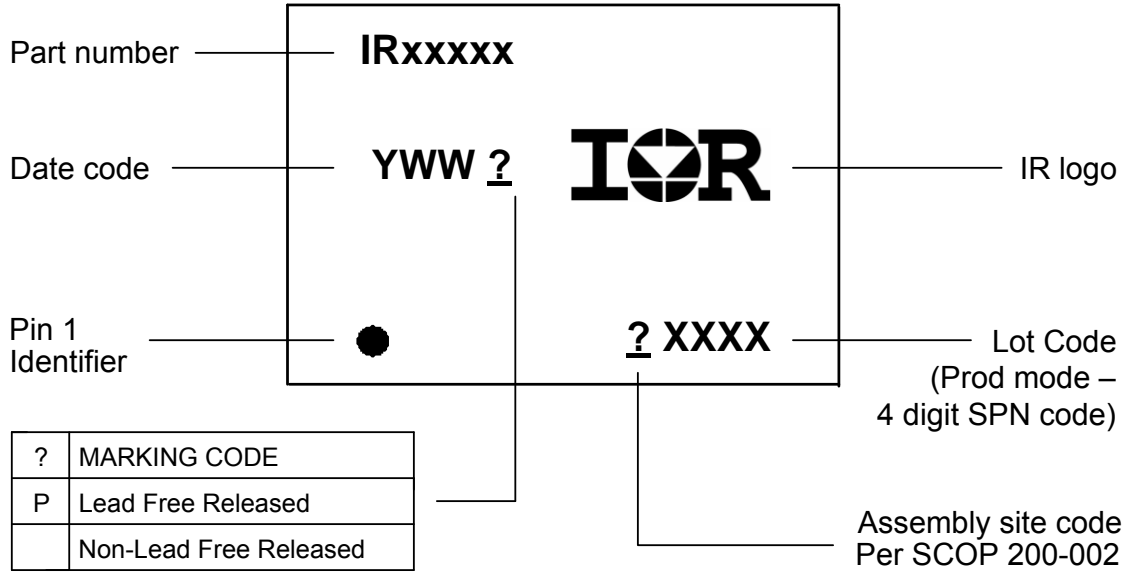


REEL DIMENSIONS FOR 8SOICN

Code	Metric		Imperial	
	Min	Max	Min	Max
A	329.60	330.25	12.976	13.001
B	20.95	21.45	0.824	0.844
C	12.80	13.20	0.503	0.519
D	1.95	2.45	0.767	0.096
E	98.00	102.00	3.858	4.015
F	n/a	18.40	n/a	0.724
G	14.50	17.10	0.570	0.673
H	12.40	14.40	0.488	0.566



**Part Marking Information**



**Qualification Information<sup>†</sup>**

<b>Qualification Level</b>	Industrial <sup>††</sup> (per JEDEC JESD 47)
	Comments: This family of ICs has passed JEDEC's Industrial qualification. IR's Consumer qualification level is granted by extension of the higher Industrial level.
<b>Moisture Sensitivity Level</b>	MSL2 <sup>†††</sup> (per IPC/JEDEC J-STD-020)
<b>RoHS Compliant</b>	Yes

- † Qualification standards can be found at International Rectifier's web site <http://www.irf.com/>
- †† Higher qualification ratings may be available should the user have such requirements. Please contact your International Rectifier sales representative for further information.
- ††† Higher MSL ratings may be available for the specific package types listed here. Please contact your International Rectifier sales representative for further information.

The information provided in this document is believed to be accurate and reliable. However, International Rectifier assumes no responsibility for the consequences of the use of this information. International Rectifier assumes no responsibility for any infringement of patents or of other rights of third parties which may result from the use of this information. No license is granted by implication or otherwise under any patent or patent rights of International Rectifier. The specifications mentioned in this document are subject to change without notice. This document supersedes and replaces all information previously supplied.

For technical support, please contact IR's Technical Assistance Center  
<http://www.irf.com/technical-info/>

**WORLD HEADQUARTERS:**  
 233 Kansas St., El Segundo, California 90245  
 Tel: (310) 252-7105

# Mouser Electronics

Authorized Distributor

Click to View Pricing, Inventory, Delivery & Lifecycle Information:

[Infineon:](#)

[IR25602SPBF](#) [IR25602STRPBF](#)