

IRS2181/IRS21814(S)PbF

HIGH AND LOW SIDE DRIVER

Features

- Floating channel designed for bootstrap operation
- Fully operational to +600 V
- Tolerant to negative transient voltage, dV/dt immune
- Gate drive supply range from 10 V to 20 V
- Undervoltage lockout for both channels
- 3.3 V and 5 V input logic compatible
- Matched propagation delay for both channels
- Logic and power ground +/- 5 V offset
- Lower di/dt gate driver for better noise immunity
- Output source/sink current capability 1.4 A/1.8 A
- RoHS compliant

Packages

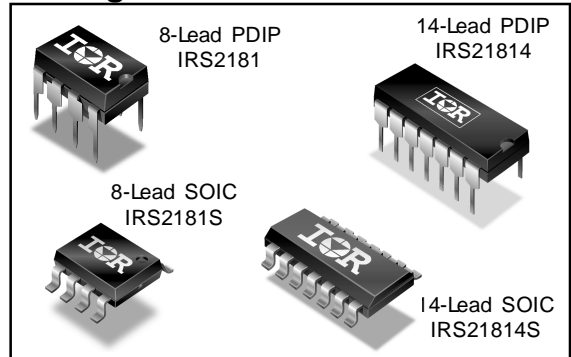

Description

The IRS2181/IRS21814 are high voltage, high speed power MOSFET and IGBT drivers with independent high-side and low-side referenced output channels. Proprietary HVIC and latch immune CMOS technologies enable ruggedized monolithic construction. The logic input is compatible with standard CMOS or LSTTL output, down to 3.3 V logic. The output drivers feature a high pulse current buffer stage designed for minimum driver cross-conduction. The floating channel can be used to drive an N-channel power MOSFET or IGBT in the high-side configuration which operates up to 600 V.

Feature Comparison

Part	Input logic	Cross-conduction prevention logic	Deadtime (ns)	Ground Pins	ton ¹ /toff (ns)
2181	HIN/LIN	no	none	COM	180/220
21814				V _{SS} /COM	
2183	HIN/LIN	yes	Internal 400	COM	180/220
21834			Program 400-5000	V _{SS} /COM	
2184	IN/SD	yes	Internal 400	COM	680/270
21844			Program 400-5000	V _{SS} /COM	

Typical Connection

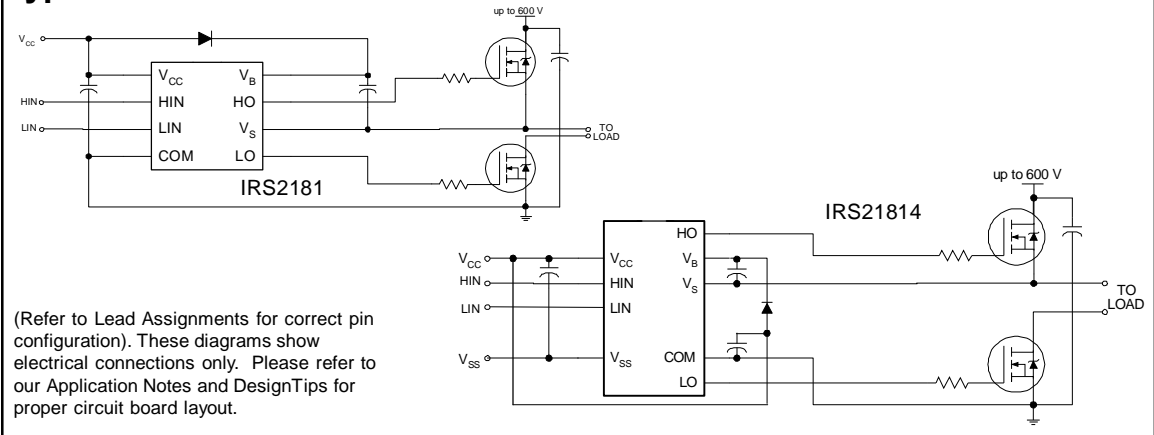

Absolute Maximum Ratings

Absolute maximum ratings indicate sustained limits beyond which damage to the device may occur. All voltage parameters are absolute voltages referenced to COM. The thermal resistance and power dissipation ratings are measured under board mounted and still air conditions.

Symbol	Definition	Min.	Max.	Units	
V_B	High-side floating absolute voltage	-0.3	620 (Note 1)	V	
V_S	High-side floating supply offset voltage	$V_B - 20$	$V_B + 0.3$		
V_{HO}	High-side floating output voltage	$V_S - 0.3$	$V_B + 0.3$		
V_{CC}	Low-side and logic fixed supply voltage	-0.3	20 (Note 1)		
V_{LO}	Low-side output voltage	-0.3	$V_{CC} + 0.3$		
V_{IN}	Logic input voltage (HIN & LIN)	$V_{SS} - 0.3$	$V_{CC} + 0.3$		
V_{SS}	Logic ground (IRS21814 only)	$V_{CC} - 20$	$V_{CC} + 0.3$		
dV_S/dt	Allowable offset supply voltage transient	—	50	V/ns	
P_D	Package power dissipation @ $T_A \leq +25\text{ }^\circ\text{C}$	(8-lead PDIP)	—	1.0	W
		(8-lead SOIC)	—	0.625	
		(14-lead PDIP)	—	1.6	
		(14-lead SOIC)	—	1.0	
R_{thJA}	Thermal resistance, junction to ambient	(8-lead PDIP)	—	125	$^\circ\text{C/W}$
		(8-lead SOIC)	—	200	
		(14-lead PDIP)	—	75	
		(14-lead SOIC)	—	120	
T_J	Junction temperature	—	150	$^\circ\text{C}$	
T_S	Storage temperature	-50	150		
T_L	Lead temperature (soldering, 10 seconds)	—	300		

Note 1: All supplies are fully tested at 25 V and an internal 20 V clamp exists for each supply.

Recommended Operating Conditions

The input/output logic timing diagram is shown in Fig. 1. For proper operation the device should be used within the recommended conditions. The V_S and V_{SS} offset rating are tested with all supplies biased at a 15 V differential.

Symbol	Definition	Min.	Max.	Units
V_B	High-side floating supply absolute voltage	$V_S + 10$	$V_S + 20$	V
V_S	High-side floating supply offset voltage	Note 2	600	
V_{HO}	High-side floating output voltage	V_S	V_B	
V_{CC}	Low-side and logic fixed supply voltage	10	20	
V_{LO}	Low-side output voltage	0	V_{CC}	
V_{IN}	Logic input voltage (HIN & LIN)	V_{SS}	V_{CC}	
V_{SS}	Logic ground (IRS21814 only)	-5	5	
T_A	Ambient temperature	-40	125	$^\circ\text{C}$

Note 2: Logic operational for V_S of -5 V to +600 V. Logic state held for V_S of -5 V to $-V_{BS}$. (Please refer to the Design Tip DT97-3 for more details).

Dynamic Electrical Characteristics

V_{BIAS} (V_{CC} , V_{BS}) = 15 V, V_{SS} = COM, C_L = 1000 pF, T_A = 25 °C.

Symbol	Definition	Min.	Typ.	Max.	Units	Test Conditions
t_{on}	Turn-on propagation delay	—	180	270	ns	$V_S = 0$ V
t_{off}	Turn-off propagation delay	—	220	330		$V_S = 0$ V or 600 V
MT	Delay matching, HS & LS turn-on/off	—	0	35		
t_r	Turn-on rise time	—	40	60		$V_S = 0$ V
t_f	Turn-off fall time	—	20	35		

Static Electrical Characteristics

V_{BIAS} (V_{CC} , V_{BS}) = 15 V, V_{SS} = COM and T_A = 25 °C unless otherwise specified. The V_{IL} , V_{IH} , and I_{IN} parameters are referenced to V_{SS}/COM and are applicable to the respective input leads HIN and LIN. The V_O , I_O , and R_{ON} parameters are referenced to COM and are applicable to the respective output leads: HO and LO.

Symbol	Definition	Min.	Typ.	Max.	Units	Test Conditions
V_{IH}	Logic "1" input voltage	2.5	—	—	V	$V_{CC} = 10$ V to 20 V
V_{IL}	Logic "0" input voltage	—	—	0.8		
V_{OH}	High level output voltage, $V_{BIAS} - V_O$	—	—	1.4		
V_{OL}	Low level output voltage, V_O	—	—	0.2		
I_{LK}	Offset supply leakage current	—	—	50	μ A	$V_B = V_S = 600$ V
I_{QBS}	Quiescent V_{BS} supply current	20	60	150		$V_{IN} = 0$ V or 5 V
I_{QCC}	Quiescent V_{CC} supply current	50	120	240		
I_{IN+}	Logic "1" input bias current	—	25	60		$V_{IN} = 5$ V
I_{IN-}	Logic "0" input bias current	—	—	5.0		$V_{IN} = 0$ V
V_{CCUV+} V_{BSUV+}	V_{CC} and V_{BS} supply undervoltage positive going threshold	8.0	8.9	9.8	V	
V_{CCUV-} V_{BSUV-}	V_{CC} and V_{BS} supply undervoltage negative going threshold	7.4	8.2	9.0		
V_{CCUVH} V_{BSUVH}	Hysteresis	0.3	0.7	—		
I_{O+}	Output high short circuit pulsed current	1.4	1.9	—	A	$V_O = 0$ V, $PW \leq 10$ μ s
I_{O-}	Output low short circuit pulsed current	1.8	2.3	—		$V_O = 15$ V, $PW \leq 10$ μ s

Functional Block Diagrams

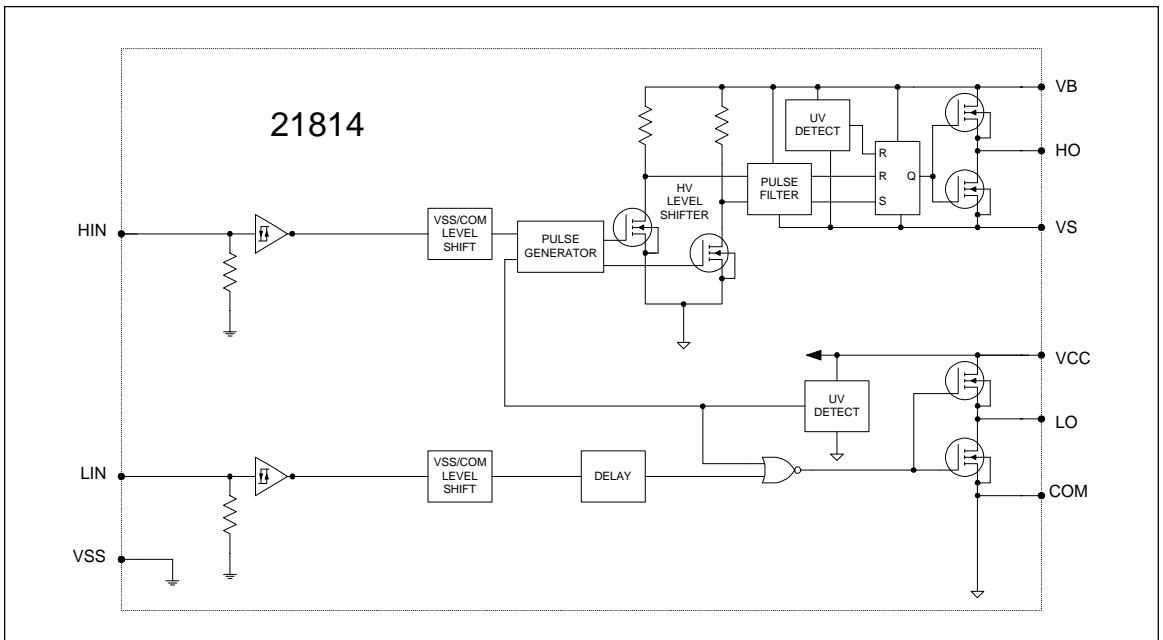
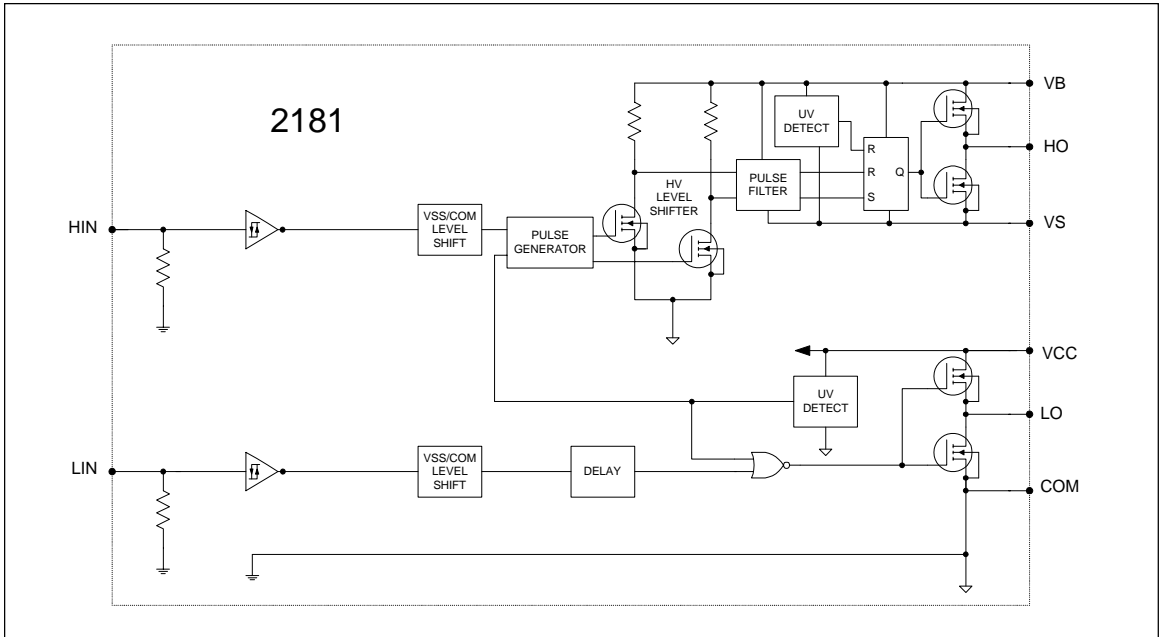

Lead Definitions

Symbol	Description
HIN	Logic input for high-side gate driver output (HO), in phase (IRS2181/IRS21814)
LIN	Logic input for low-side gate driver output (LO), in phase (IRS2181/IRS21814)
VSS	Logic ground (IRS21814 only)
V _B	High-side floating supply
HO	High-side gate drive output
V _S	High-side floating supply return
V _{CC}	Low-side and logic fixed supply
LO	Low-side gate drive output
COM	Low-side return

Lead Assignments

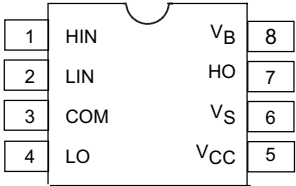
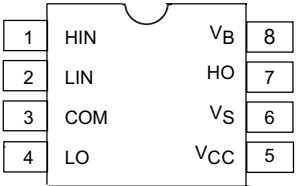
 <p>8-Lead PDIP</p>	 <p>8-Lead SOIC</p>
IRS2181PbF	IRS2181SPbF

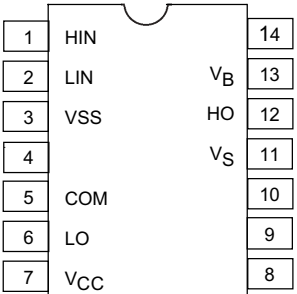
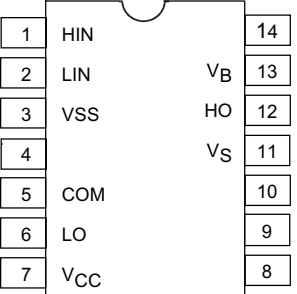
 <p>14-Lead PDIP</p>	 <p>14-Lead SOIC</p>
IRS21814PbF	IRS21814SPbF

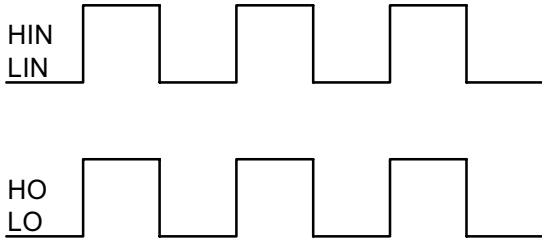

Figure 1. Input/Output Timing Diagram

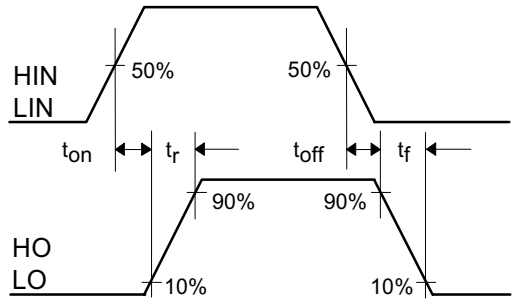

Figure 2. Switching Time Waveform Definitions

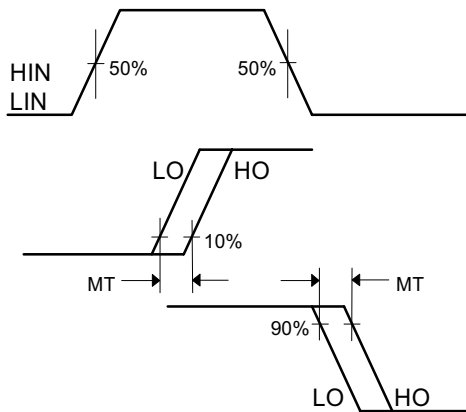

Figure 3. Delay Matching Waveform Definitions

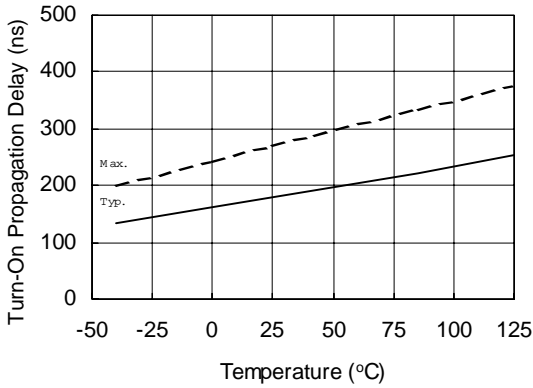

Figure 4A. Turn-On Propagation Delay vs. Temperature

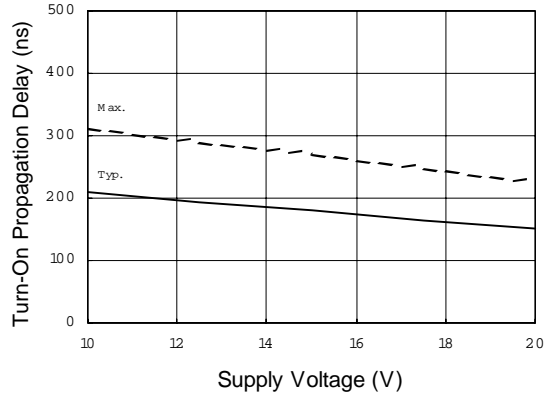

Figure 4B. Turn-On Propagation Delay vs. Supply Voltage

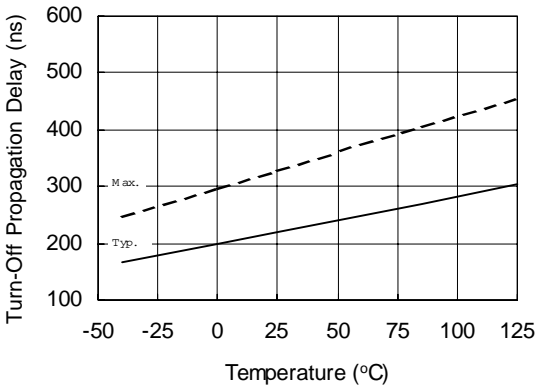

Figure 5A. Turn-Off Propagation Delay vs. Temperature

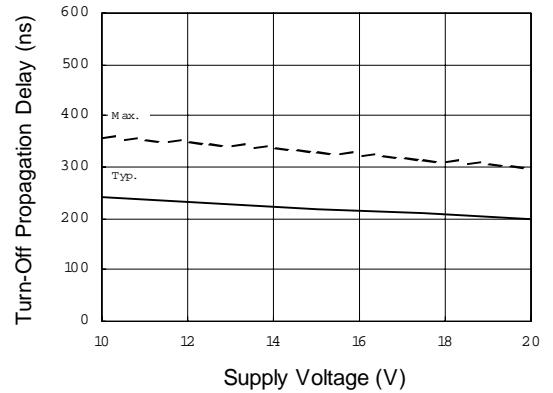

Figure 5B. Turn-Off Propagation Delay vs. Supply Voltage

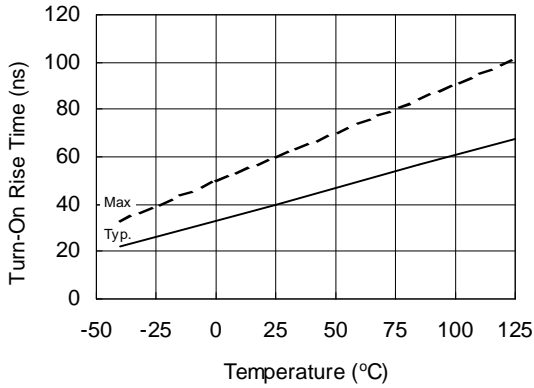

Figure 6A. Turn-On Rise Time vs. Temperature

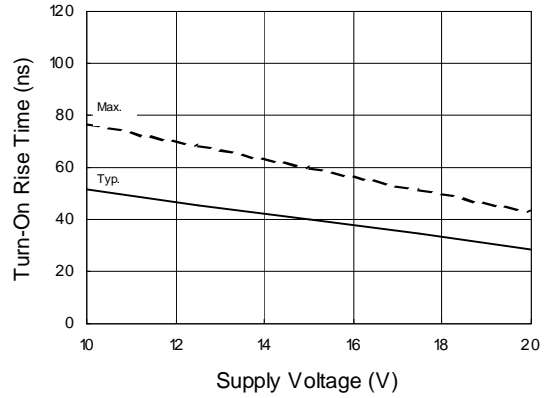

Figure 6B. Turn-On Rise Time vs. Supply Voltage

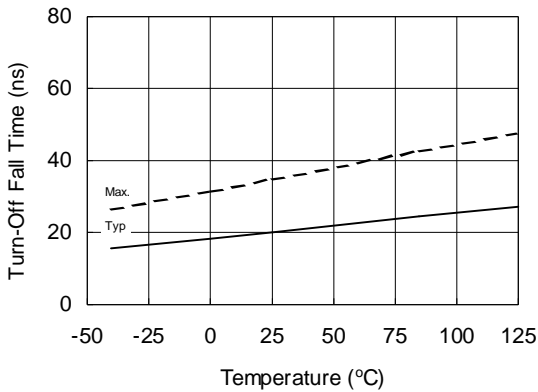

Figure 7A. Turn-Off Fall Time vs. Temperature

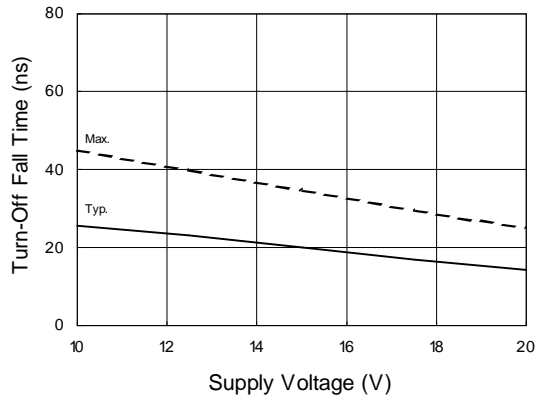

Figure 7B. Turn-Off Fall Time vs. Supply Voltage

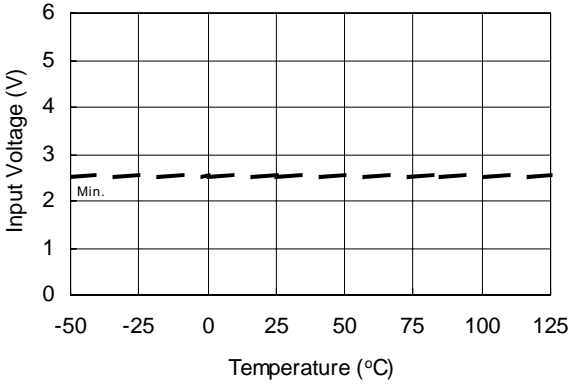

Figure 8A. Logic "1" Input Voltage vs. Temperature

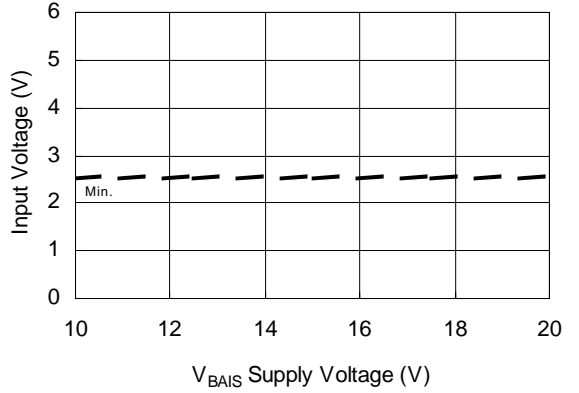

Figure 8B. Logic "1" Input Voltage vs. Supply Voltage

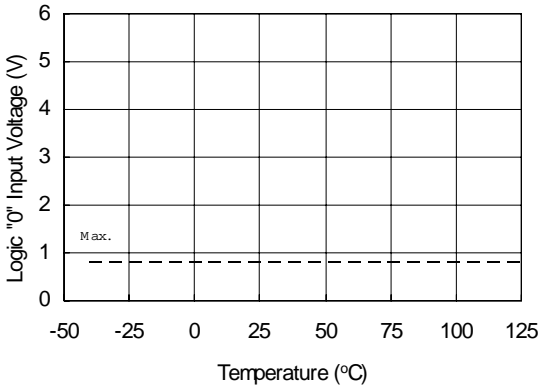

Figure 9A. Logic "0" Input Voltage vs. Temperature

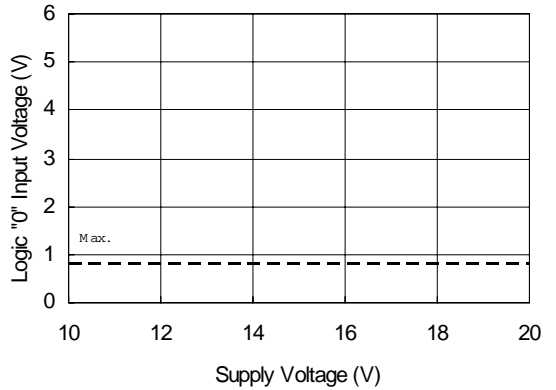

Figure 9B. Logic "0" Input Voltage vs. Supply Voltage

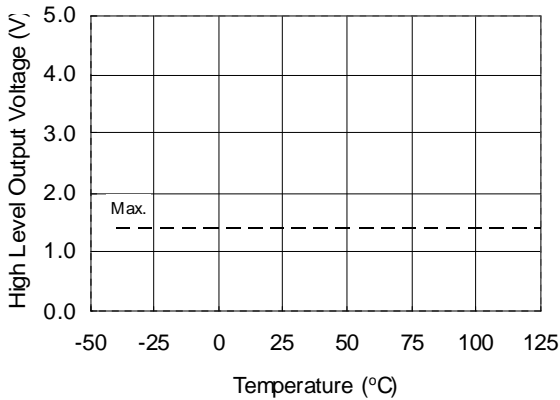

Figure 10A. High Level Output Voltage vs. Temperature ($I_O = 0$ mA)

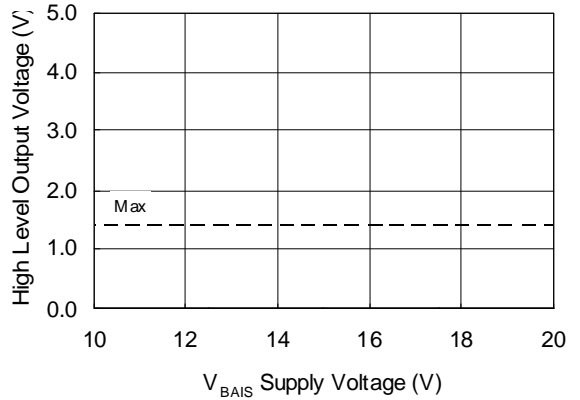

Figure 10B. High Level Output Voltage vs. Supply Voltage ($I_O = 0$ mA)

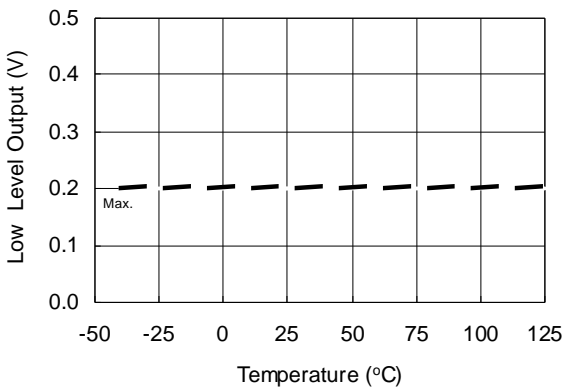

Figure 11A. Low Level Output vs. Temperature

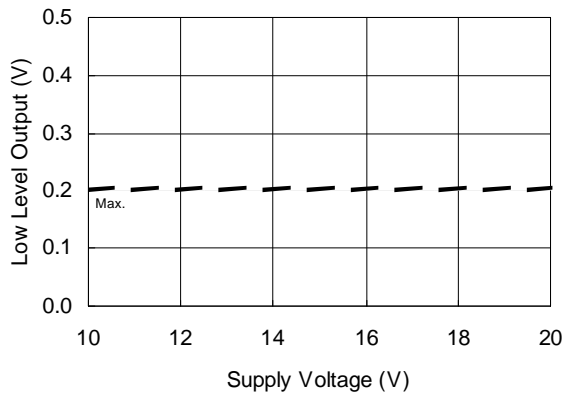

Figure 11B. Low Level Output vs. Supply Voltage

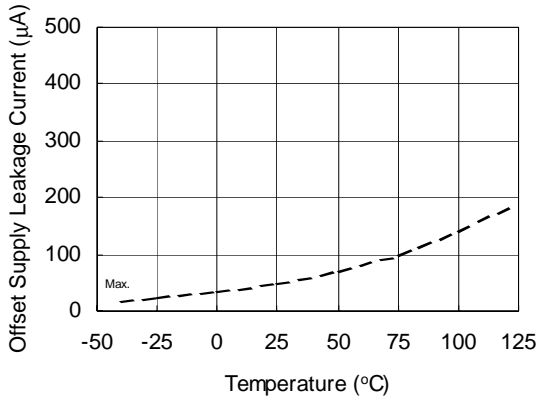

Figure 12A. Offset Supply Leakage Current vs. Temperature

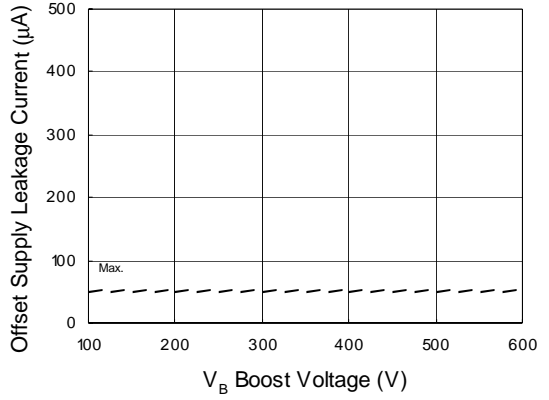

Figure 12B. Offset Supply Leakage Current vs. V_B Boost Voltage

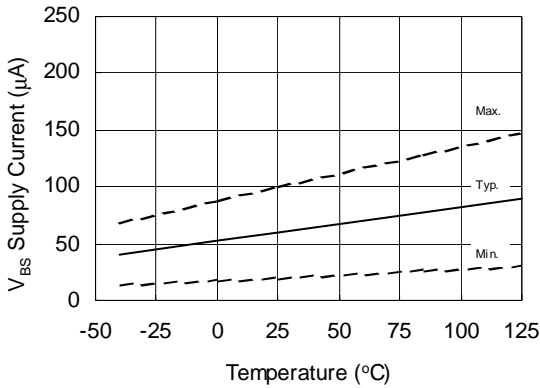

Figure 13A. V_{BS} Supply Current vs. Temperature

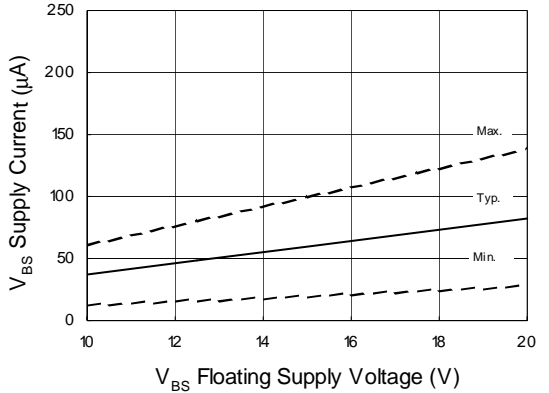

Figure 13B. V_{BS} Supply Current vs. V_{BS} Floating Supply Voltage

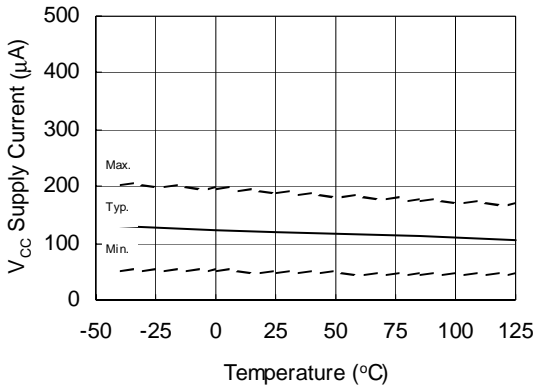

Figure 14A. V_{CC} Supply Current vs. V_{CC} Temperature

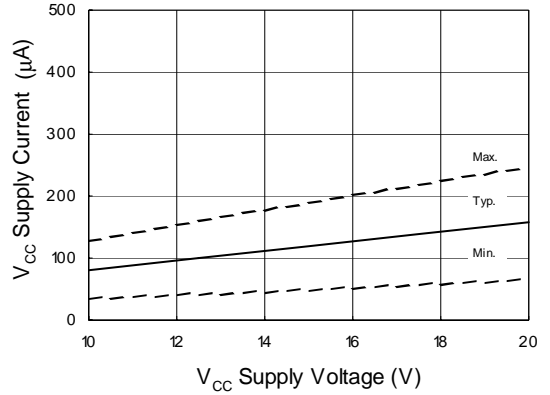

Figure 14B. V_{CC} Supply Current vs. V_{CC} Supply Voltage

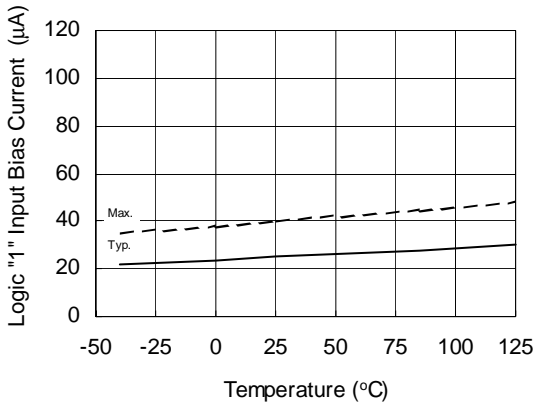

Figure 15A. Logic "1" Input Bias Current vs. Temperature

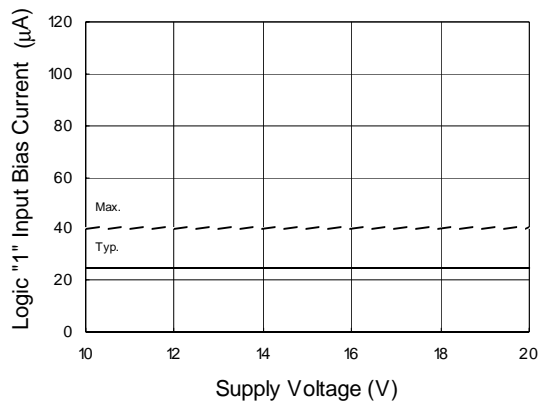

Figure 15B. Logic "1" Input Bias Current vs. Supply Voltage

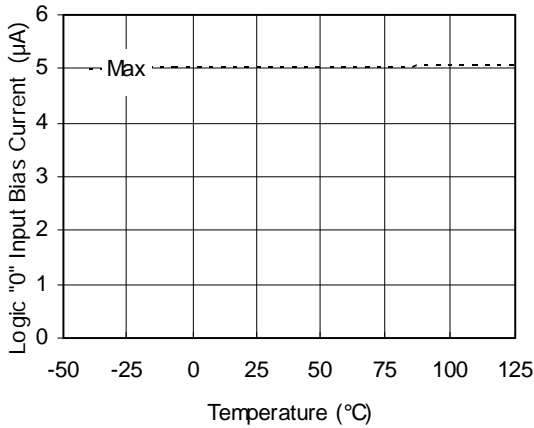

Figure 16A. Logic "0" Input Bias Current vs. Temperature

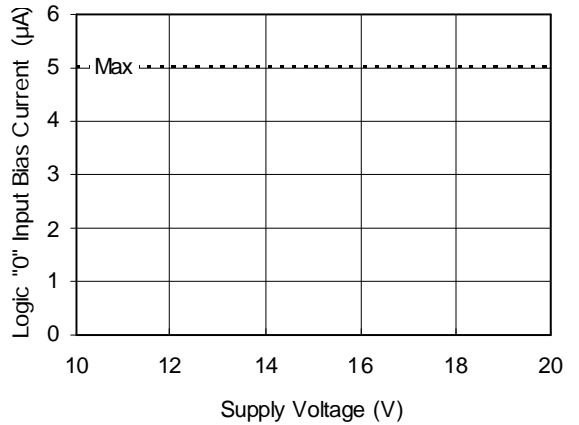

Figure 16B. Logic "0" Input Bias Current vs. Voltage

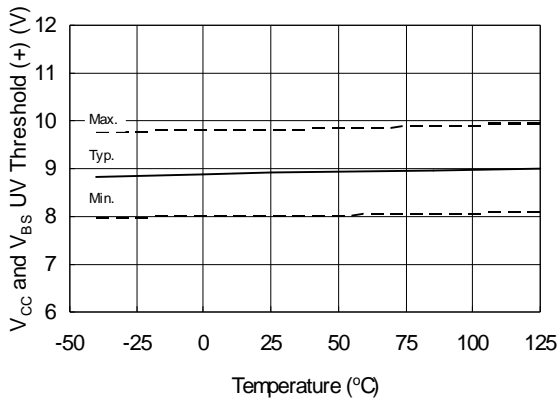

Figure 17. V_{CC} and V_{BS} Undervoltage Threshold (+) vs. Temperature

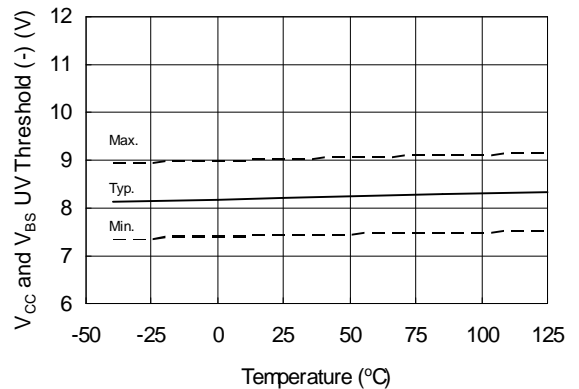

Figure 18. V_{CC} and V_{BS} Undervoltage Threshold (-) vs. Temperature

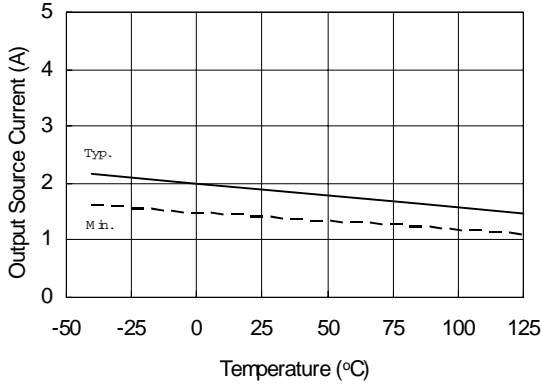

Figure 19A. Output Source Current vs. Temperature

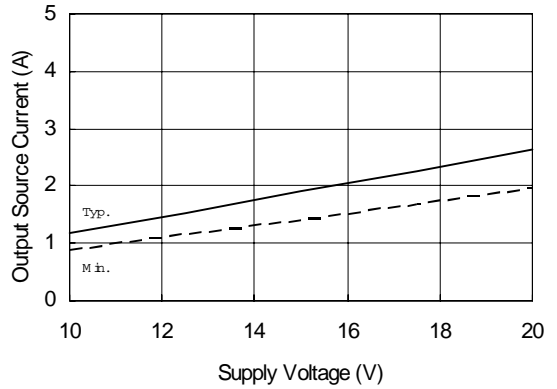

Figure 19B. Output Source Current vs. Supply Voltage

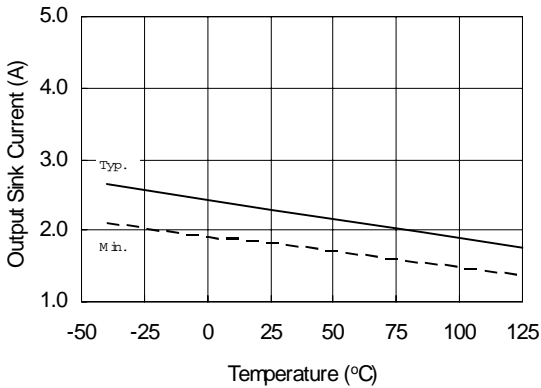

Figure 20A. Output Sink Current vs. Temperature

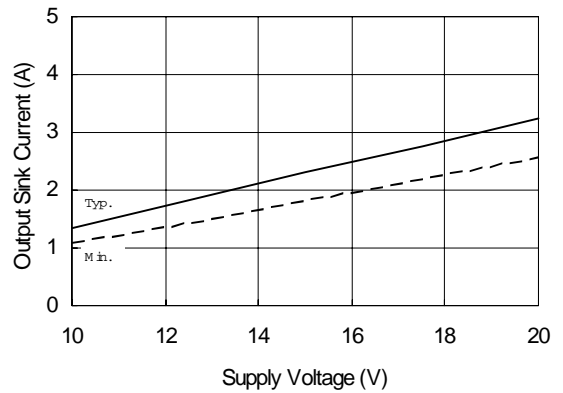
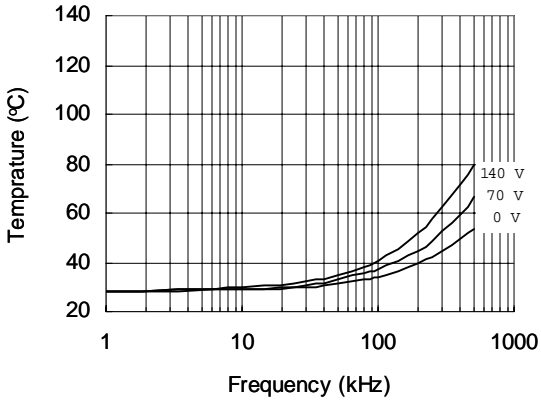
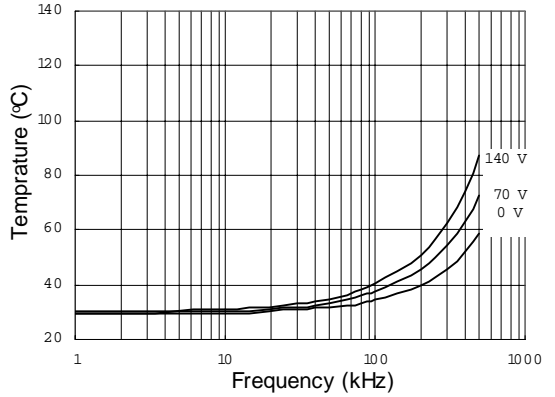

Figure 20B. Output Sink Current vs. Supply Voltage



**Figure 21. IRS2181 vs. Frequency (IRFBC20),
 $R_{gate}=33 \Omega, V_{cc}=15 V$**



**Figure 22. IRS2181 vs. Frequency (IRFBC30),
 $R_{gate}=22 \Omega, V_{cc}=15 V$**

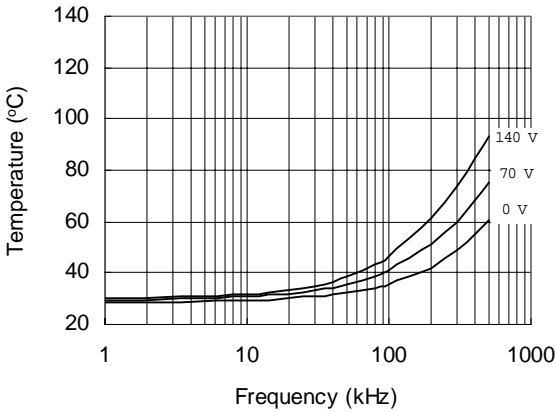

**Figure 23. IRS2181 vs. Frequency (IRFBC40),
 $R_{gate}=15 \Omega, V_{cc}=15 V$**

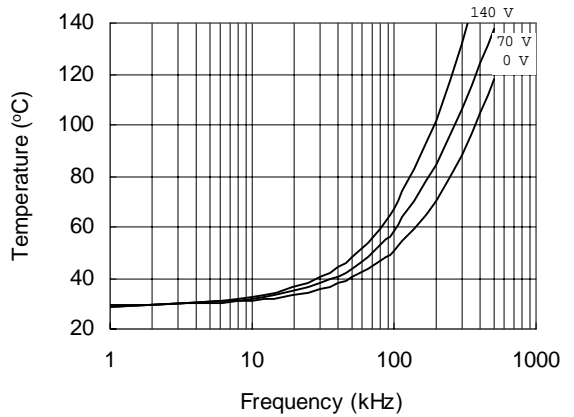

**Figure 24. IRS2181 vs. Frequency (IRFPE50),
 $R_{gate}=10 \Omega, V_{cc}=15 V$**

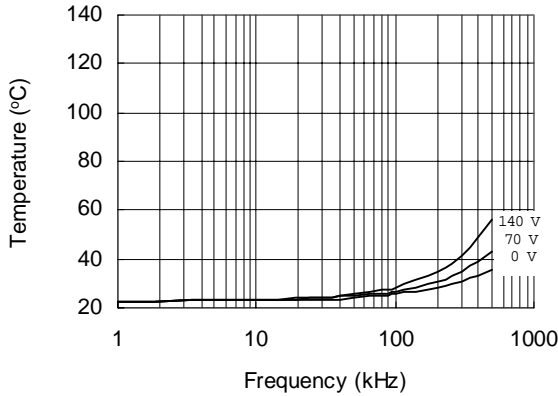

**Figure 25. IRS21814 vs. Frequency (IRFBC20),
 $R_{gate}=33 \Omega$, $V_{CC}=15 V$**

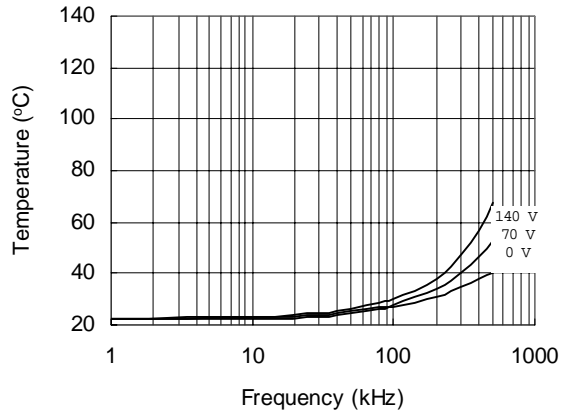

**Figure 26. IRS21814 vs. Frequency (IRFBC30),
 $R_{gate}=22 \Omega$, $V_{CC}=15 V$**

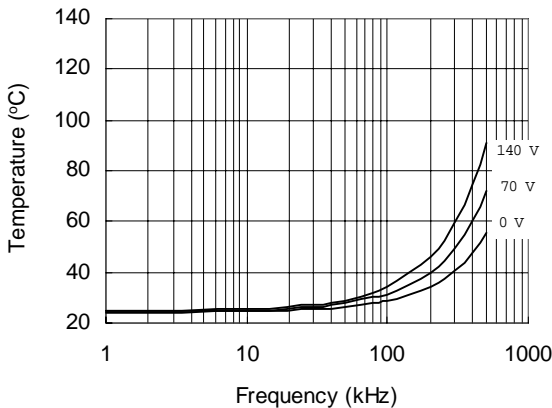

**Figure 27. IRS21814 vs. Frequency (IRFBC40),
 $R_{gate}=15 \Omega$, $V_{CC}=15 V$**

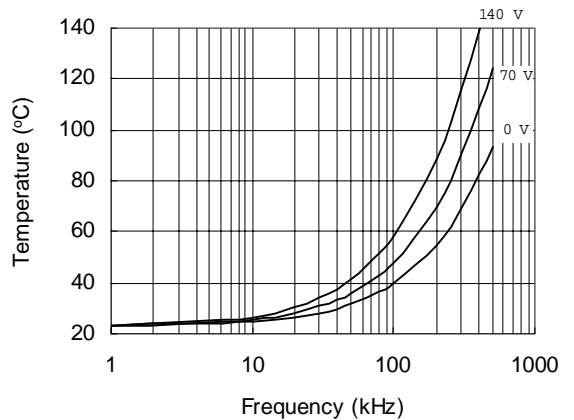

**Figure 28. IRS21814 vs. Frequency (IRFPE50),
 $R_{gate}=10 \Omega$, $V_{CC}=15 V$**

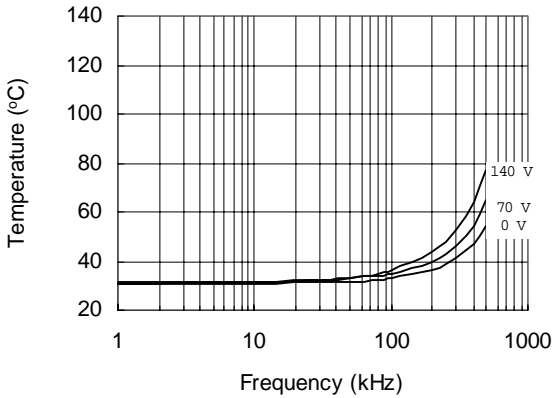

Figure 29. IRS2181S vs. Frequency (IRFBC20),
 $R_{gate}=33 \Omega, V_{CC}=15 V$

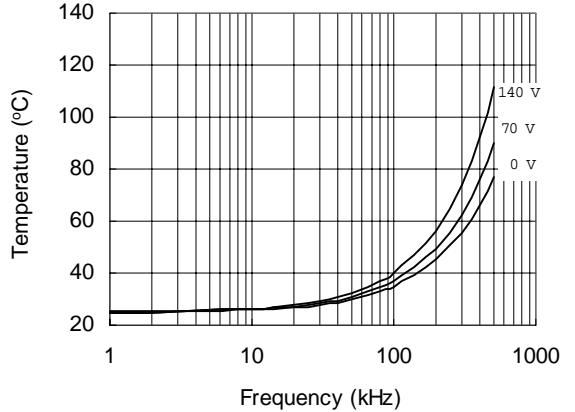

Figure 30. IRS2181S vs. Frequency (IRFBC30),
 $R_{gate}=22 \Omega, V_{CC}=15 V$

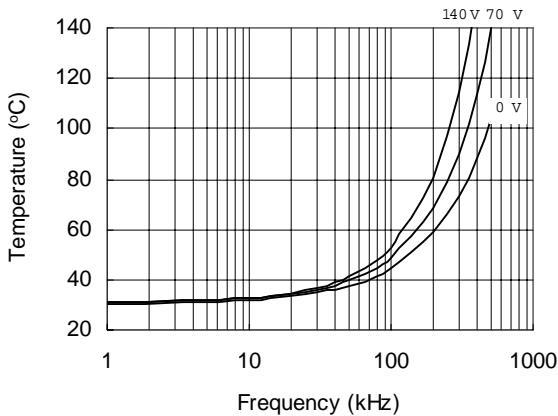

Figure 31. IRS2181S vs. Frequency (IRFBC40),
 $R_{gate}=15 \Omega, V_{CC}=15 V$

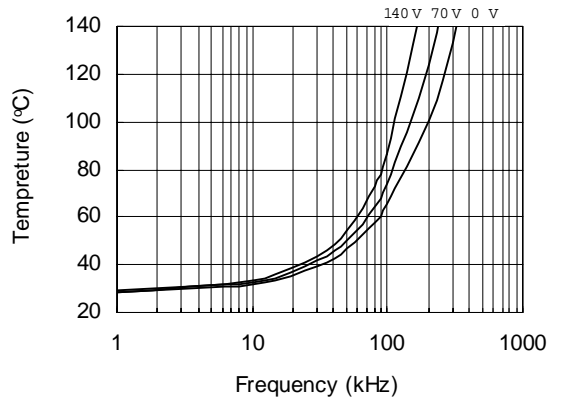
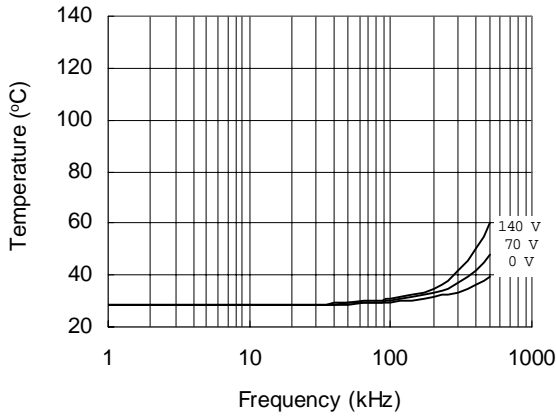
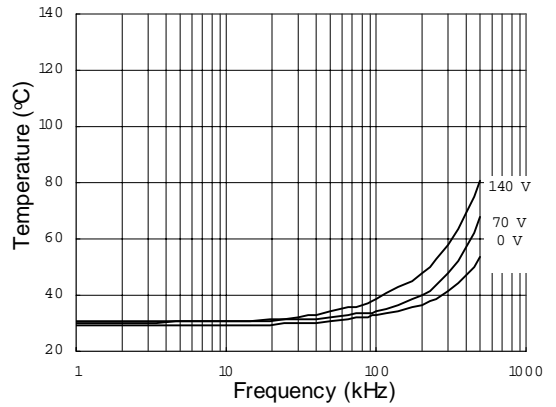

Figure 32. IRS2181S vs. Frequency (IRFPE50),
 $R_{gate}=10 \Omega, V_{CC}=15 V$



**Figure 33. IRS21814S vs. Frequency (IRFBC20),
 $R_{gate}=33 \Omega$, $V_{cc}=15 V$**



**Figure 34. IRS21814S vs. Frequency (IRFBC30),
 $R_{gate}=22 \Omega$, $V_{cc}=15 V$**

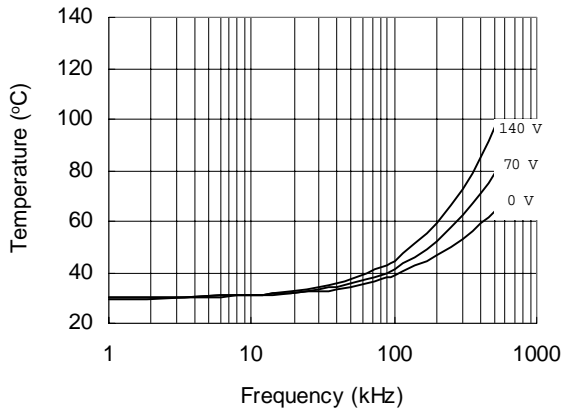

**Figure 35. IRS21814S vs. Frequency (IRFBC40),
 $R_{gate}=15 \Omega$, $V_{cc}=15 V$**

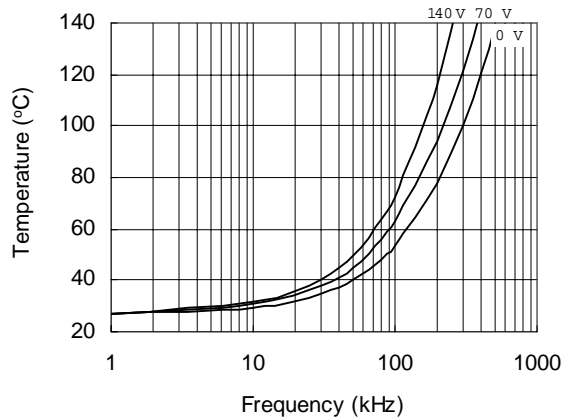

**Figure 36. IRS21814S vs. Frequency (IRFPE50),
 $R_{gate}=10 \Omega$, $V_{cc}=15 V$**

Case outlines

8-Lead PDIP

01-6014
01-3003 01 (MS-001AB)

NOTES:

1. DIMENSIONING & TOLERANCING PER ANSI Y14.5M-1982.
2. CONTROLLING DIMENSION: INCH.
3. DIMENSIONS ARE SHOWN IN MILLIMETERS [INCHES].
4. OUTLINE CONFORMS TO JEDEC OUTLINE MS-001AB.
- ⑤ MEASURED WITH THE LEADS CONSTRAINED TO BE PERPENDICULAR TO DATUM PLANE C.
- ⑥ DIMENSION DOES NOT INCLUDE MOLD PROTUSIONS. MOLD PROTUSIONS SHALL NOT EXCEED 0.25 [.010].

8-Lead SOIC

01-6027
01-0021 11 (MS-012AA)

DIM	INCHES		MILLIMETERS	
	MIN	MAX	MIN	MAX
A	.0532	.0688	1.35	1.75
A1	.0040	.0098	0.10	0.25
b	.013	.020	0.33	0.51
c	.0075	.0098	0.19	0.25
D	.189	.1968	4.80	5.00
E	.1497	.1574	3.80	4.00
e	.050 BASIC		1.27 BASIC	
e1	.025 BASIC		0.635 BASIC	
H	.2284	.2440	5.80	6.20
K	.0099	.0196	0.25	0.50
L	.016	.050	0.40	1.27
y	0°	8°	0°	8°

NOTES:

1. DIMENSIONING & TOLERANCING PER ASME Y14.5M-1994.
2. CONTROLLING DIMENSION: MILLIMETER
3. DIMENSIONS ARE SHOWN IN MILLIMETERS [INCHES].
4. OUTLINE CONFORMS TO JEDEC OUTLINE MS-012AA.
- ⑤ DIMENSION DOES NOT INCLUDE MOLD PROTUSIONS. MOLD PROTUSIONS NOT TO EXCEED 0.15 [.006].
- ⑥ DIMENSION DOES NOT INCLUDE MOLD PROTUSIONS. MOLD PROTUSIONS NOT TO EXCEED 0.25 [.010].
- ⑦ DIMENSION IS THE LENGTH OF LEAD FOR SOLDERING TO A SUBSTRATE.

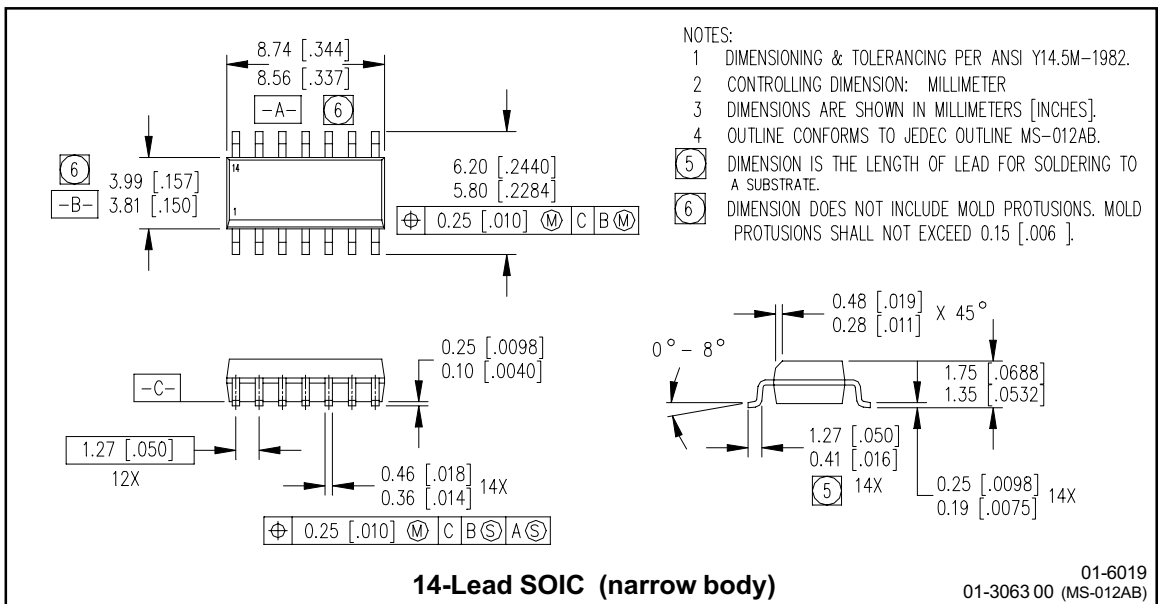
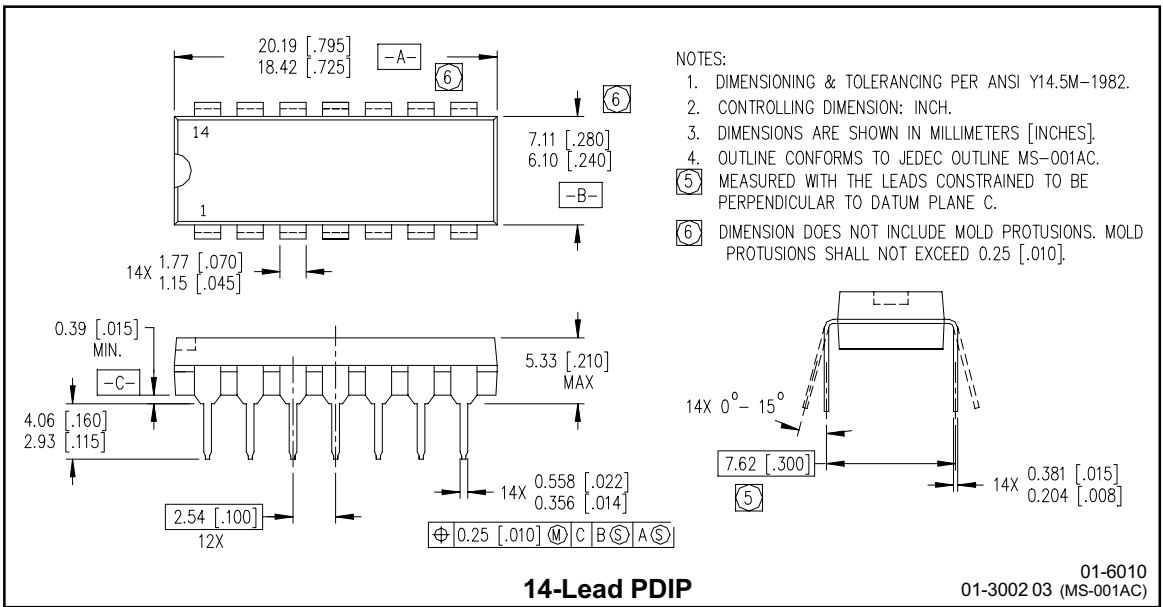

Tape & Reel 8-lead SOIC

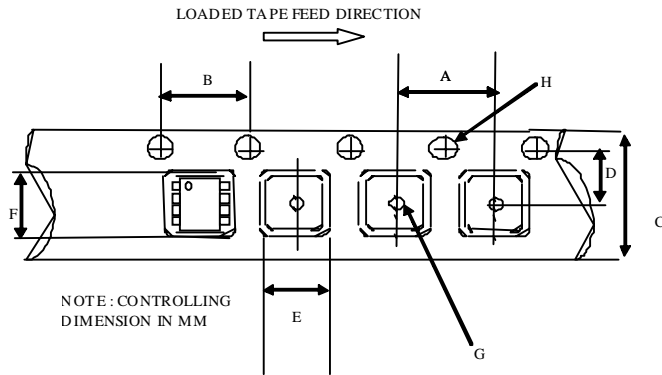

CARRIER TAPE DIMENSION FOR 8SOICN

Code	Metric		Imperial	
	Min	Max	Min	Max
A	7.90	8.10	0.311	0.318
B	3.90	4.10	0.153	0.161
C	11.70	12.30	0.46	0.484
D	5.45	5.55	0.214	0.218
E	6.30	6.50	0.248	0.255
F	5.10	5.30	0.200	0.208
G	1.50	n/a	0.059	n/a
H	1.50	1.60	0.059	0.062

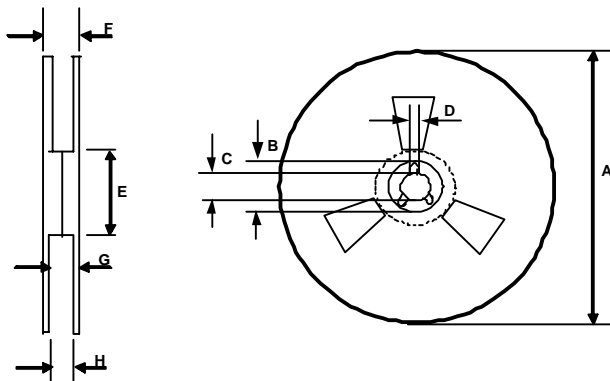

REEL DIMENSIONS FOR 8SOICN

Code	Metric		Imperial	
	Min	Max	Min	Max
A	329.60	330.25	12.976	13.001
B	20.95	21.45	0.824	0.844
C	12.80	13.20	0.503	0.519
D	1.95	2.45	0.767	0.096
E	98.00	102.00	3.858	4.015
F	n/a	18.40	n/a	0.724
G	14.50	17.10	0.570	0.673
H	12.40	14.40	0.488	0.566

Tape & Reel 14-lead SOIC

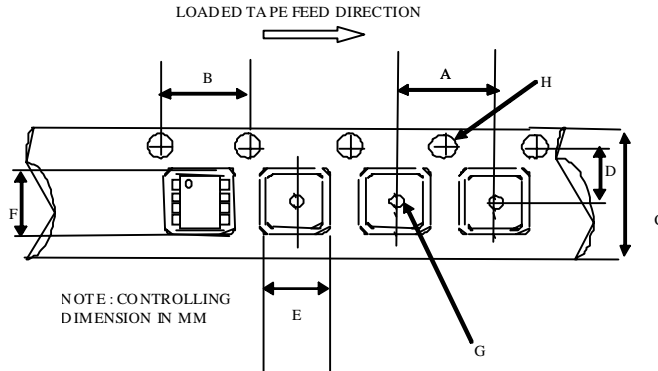

CARRIER TAPE DIMENSION FOR 14SOICN

Code	Metric		Imperial	
	Min	Max	Min	Max
A	7.90	8.10	0.311	0.318
B	3.90	4.10	0.153	0.161
C	15.70	16.30	0.618	0.641
D	7.40	7.60	0.291	0.299
E	6.40	6.60	0.252	0.260
F	9.40	9.60	0.370	0.378
G	1.50	n/a	0.059	n/a
H	1.50	1.60	0.059	0.062

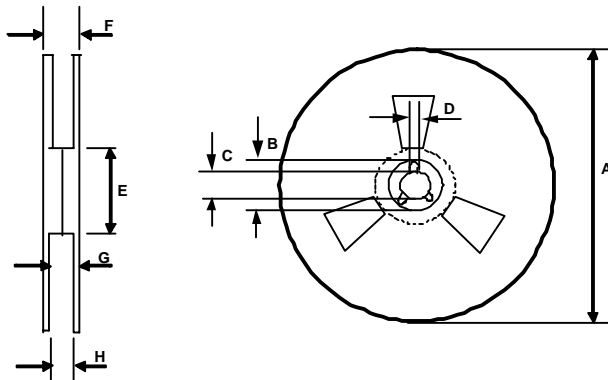

REEL DIMENSIONS FOR 14SOICN

Code	Metric		Imperial	
	Min	Max	Min	Max
A	329.60	330.25	12.976	13.001
B	20.95	21.45	0.824	0.844
C	12.80	13.20	0.503	0.519
D	1.95	2.45	0.767	0.096
E	98.00	102.00	3.858	4.015
F	n/a	22.40	n/a	0.881
G	18.50	21.10	0.728	0.830
H	16.40	18.40	0.645	0.724

LEADFREE PART MARKING INFORMATION

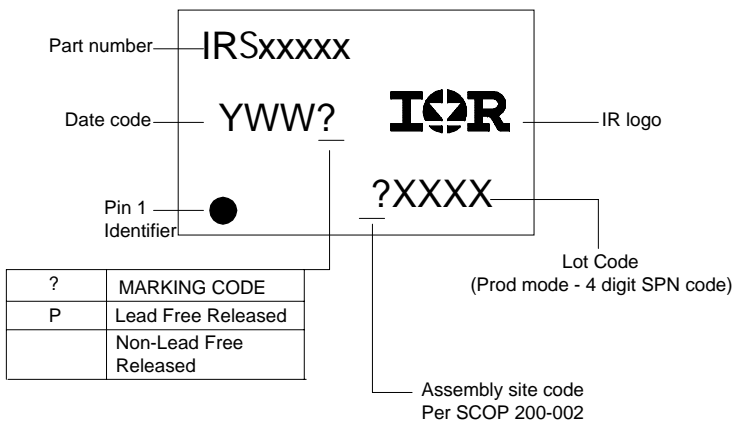

ORDER INFORMATION

8-Lead PDIP IRS2181PbF
 8-Lead SOIC IRS2181SPbF
 8-Lead SOIC Tape & Reel IRS2181STRPbF

14-Lead PDIP IRS21814PbF
 14-Lead SOIC IRS21814SPbF
 14-Lead SOIC Tape & Reel IRS21814STRPbF