

Features

- Clocking speeds up to 40MHz
- 4 channels
- 12ns tr/ff at 1000pF C_{LOAD}
- 1ns rise and fall time match
- 1.5ns prop delay match
- Low quiescent current - <1mA
- Fast output enable function - 12ns
- Wide output voltage range
- $8V \geq V_L \geq -5V$
- $-2V \leq V_H \leq 15V$
- 2A peak drive
- 3Ω on resistance
- Input level shifters
- TTL/CMOS input-compatible

Applications

- CCD drivers
- Digital cameras
- Pin drivers
- Clock/line drivers
- Ultrasound transducer drivers
- Ultrasonic and RF generators
- Level shifting

Ordering Information

Part No.	Package	Tape & Reel	Outline #
EL7457CU	16-Pin QSOP	-	MDP0040
EL7457CU-T13	16-Pin QSOP	13"	MDP0040
EL7457CS	16-Pin SO (0.150")	-	MDP0027
EL7457CS-T7	16-Pin SO (0.150")	7"	MDP0027
EL7457CS-T13	16-Pin SO (0.150")	13"	MDP0027

General Description

The EL7457C is a high speed, non-inverting, quad CMOS driver. It is capable of running at clock rates up to 40MHz and features 2A peak drive capability and a nominal on-resistance of just 3Ω. The EL7457C is ideal for driving highly capacitive loads, such as storage and vertical clocks in CCD applications. It is also well suited to ATE pin driving, level-shifting, and clock-driving applications.

The EL7457C is capable of running from single or dual power supplies while using ground referenced inputs. Each output can be switched to either the high (V_H) or low (V_L) supply pins, depending on the related input pin. The inputs are compatible with both 3V and 5V CMOS and TTL logic. The output enable (OE) pin can be used to put the outputs into a high-impedance state. This is especially useful in CCD applications, where the driver should be disabled during power down.

The EL7457C also features very fast rise and fall times which are matched to within 1ns. The propagation delay is also matched between rising and falling edges to within 2ns.

The EL7457C is available in both 16-pin QSOP and 16-pin SO (0.150") packages. It is specified for operation over the full -40°C to +85°C temperature range.

Connection Diagram

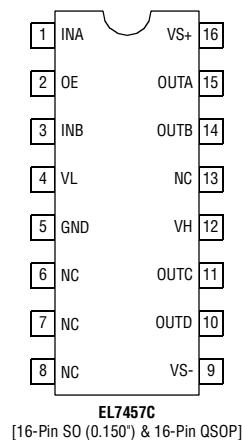

Note: All information contained in this data sheet has been carefully checked and is believed to be accurate as of the date of publication; however, this data sheet cannot be a "controlled document". Current revisions, if any, to these specifications are maintained at the factory and are available upon your request. We recommend checking the revision level before finalization of your design documentation.

EL7457C

40MHz Non-Inverting Quad CMOS Driver

Absolute Maximum Ratings (T_A = 25°C)

Absolute maximum ratings are those values beyond which the device could be permanently damaged. Absolute maximum ratings are stress ratings only and functional device operation is not implied.

Supply Voltage (V _{S+} to V _{S-})	+16.5V
Input Voltage	V _{S-} -0.3V, V _{S+} +0.3V
Continuous Output Current	100mA

Storage Temperature Range	-65°C to +150°C
Ambient Operating Temperature	-40°C to +85°C
Maximum Die Temperature	+125°C
Power Dissipation	See Curves
Maximum ESD	2kV

Important Note:

All parameters having Min/Max specifications are guaranteed. Typ values are for information purposes only. Unless otherwise noted, all tests are at the specified temperature and are pulsed tests, therefore: T_J = T_C = T_A.

Electrical Characteristics

V_{S+} = +5V, V_{S-} = -5V, V_H = +5V, V_L = -5V, T_A = 25°C, unless otherwise specified.

Parameter	Description	Condition	Min	Typ	Max	Unit
Input						
V _{IH}	Logic "1" Input Voltage		2.0			V
I _{IH}	Logic "1" Input Current	V _{IH} = 5V		0.1	10	μA
V _{IL}	Logic "0" Input Voltage				0.8	V
I _{IL}	Logic "0" Input Current	V _{IL} = 0V		0.1	10	μA
C _{IN}	Input Capacitance			3.5		pF
R _{IN}	Input Resistance			50		MΩ
Output						
R _{OH}	ON Resistance V _H to OUTx	I _{OUT} = -100mA		4.5	6	Ω
R _{OL}	ON Resistance V _L to OUTx	I _{OUT} = +100mA		4	6	Ω
I _{LEAK}	Output Leakage Current	V _H = V _{S+} , V _L = V _{S-}		0.1	10	μA
I _{PK}	Peak Output Current	Source		2.0		A
		Sink		2.0		A
Power Supply						
I _S	Power Supply Current	Inputs = V _{S+}		0.5	1.5	mA
Switching Characteristics						
t _R	Rise Time	C _L = 1000pF		13.5		ns
t _F	Fall Time	C _L = 1000pF		13		ns
t _{RFA}	t _R , t _F Mismatch	C _L = 1000pF		0.5		ns
t _{D+}	Turn-Off Delay Time	C _L = 1000pF		12.5		ns
t _{D-}	Turn-On Delay Time	C _L = 1000pF		14.5		ns
t _{DD}	t _{D,1} - t _{D,2} Mismatch	C _L = 1000pF		2		ns
T _{ENABLE}	Enable Delay Time			12		ns
T _{DISABLE}	Disable Delay Time			12		ns

EL7457C

40MHz Non-Inverting Quad CMOS Driver

EL7457C

Electrical Characteristics

$V_{S+} = +15V$, $V_{S-} = 0V$, $V_H = +15V$, $V_L = 0V$, $T_A = 25^\circ C$, unless otherwise specified

Parameter	Description	Condition	Min	Typ	Max	Unit
Input						
V_{IH}	Logic "1" Input Voltage		2.4			V
I_{IH}	Logic "1" Input Current	$V_{IH} = 5V$		0.1	10	μA
V_{IL}	Logic "0" Input Voltage				0.8	V
I_{IL}	Logic "0" Input Current	$V_{IL} = 0V$		0.1	10	μA
C_{IN}	Input Capacitance			3.5		pF
R_{IN}	Input Resistance			50		M Ω
Output						
R_{OH}	ON Resistance V_H to OUT	$I_{OUT} = -100mA$		3.5	5	Ω
R_{OL}	ON Resistance V_L to OUT	$I_{OUT} = +100mA$		3	5	Ω
I_{LEAK}	Output Leakage Current	$V_H = V_{S+}$, $V_L = V_{S-}$		0.1	10	μA
I_{PK}	Peak Output Current	Source		2.0		A
		Sink		2.0		A
Power Supply						
I_S	Power Supply Current	Inputs = V_{S+}		0.8	2	mA
Switching Characteristics						
t_R	Rise Time	$C_L = 1000pF$		11		ns
t_F	Fall Time	$C_L = 1000pF$		12		ns
t_{RFA}	t_R , t_F Mismatch	$C_L = 1000pF$		1		ns
t_{D+}	Turn-Off Delay Time	$C_L = 1000pF$		11.5		ns
t_{D-}	Turn-On Delay Time	$C_L = 1000pF$		13		ns
t_{DD}	$t_{D-1} - t_{D-2}$ Mismatch	$C_L = 1000pF$		1.5		ns
T_{ENABLE}	Enable Delay Time			12		ns
$T_{DISABLE}$	Disable Delay Time			12		ns

EL7457C

40MHz Non-Inverting Quad CMOS Driver

Typical Performance Curves

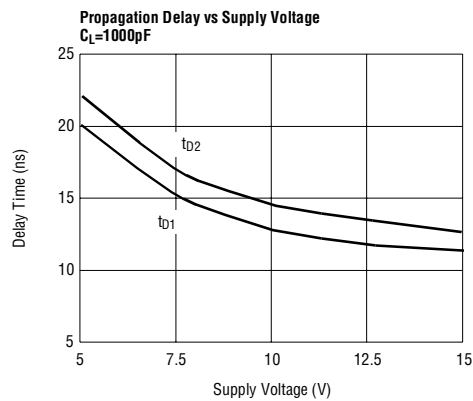
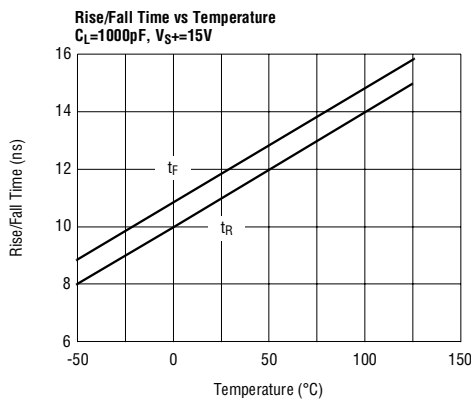
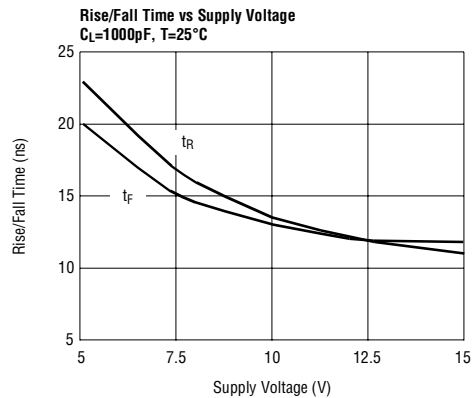
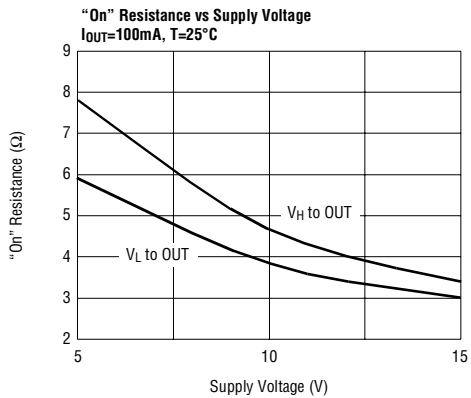
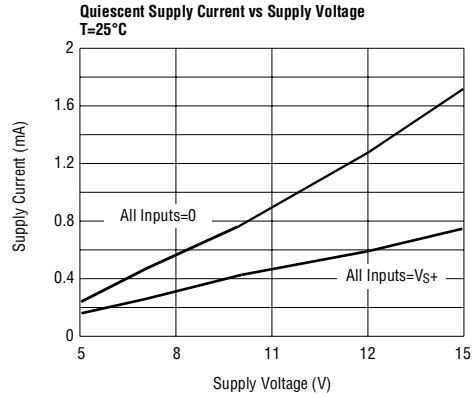
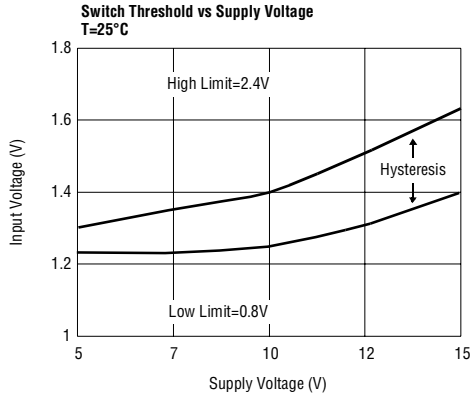

Typical Performance Curves

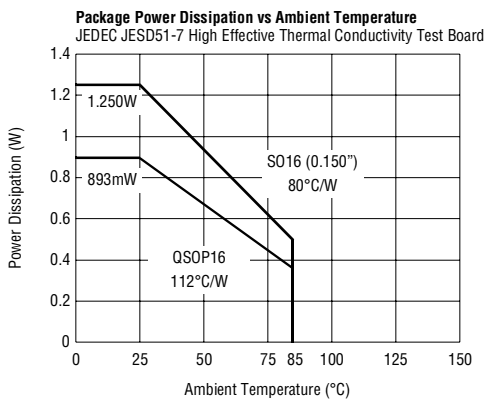
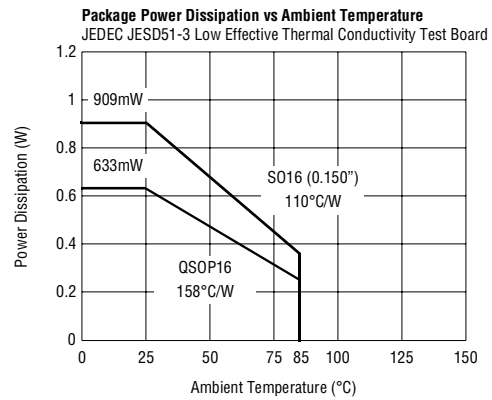
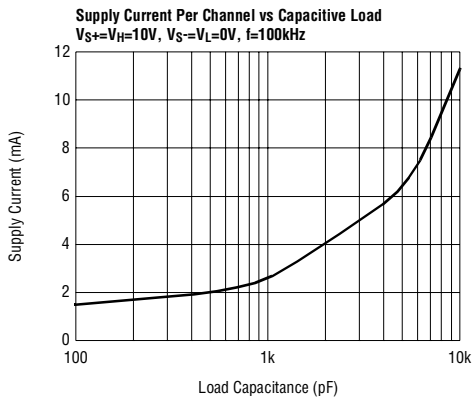
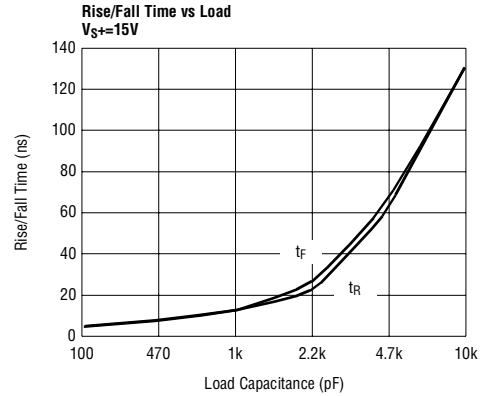
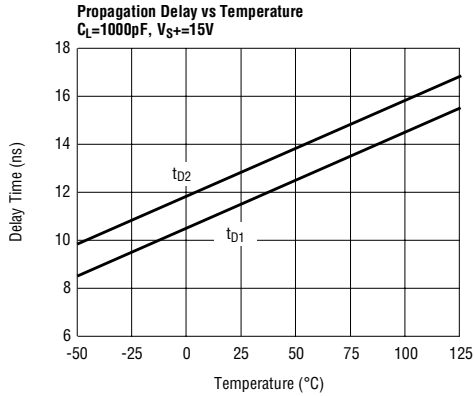

EL7457C**40MHz Non-Inverting Quad CMOS Driver****Nominal Operating Voltage Range**

Pin	Min	Max
V_{S+} to V_{S-}	5V	15V
V_{S-} to GND	-5V	0V
V_H	$V_{S-} + 2.5V$	V_{S+}
V_L	V_{S-}	V_{S+}
V_H to V_L	0V	15V
V_L to V_{S-}	0V	8V

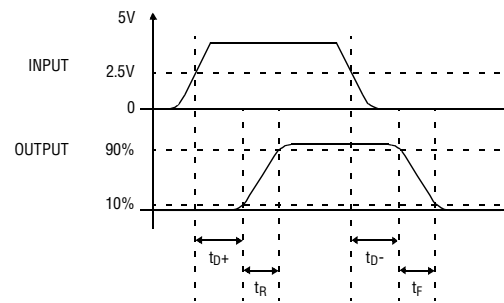
Timing Diagram

EL7457C

40MHz Non-Inverting Quad CMOS Driver

EL7457C

Standard Test Configuration

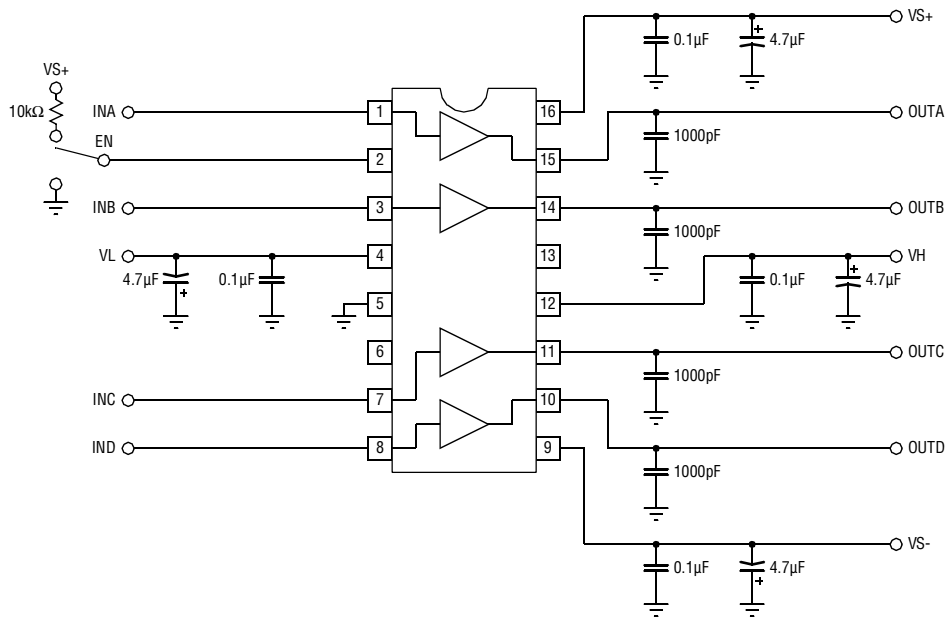

EL7457C

40MHz Non-Inverting Quad CMOS Driver

Pin Descriptions

Pin	Name	Function	Equivalent Circuit
1	INA	Input channel A	<p style="text-align: center;">Circuit 1</p>
2	OE	Output Enable	(Reference Circuit 1)
3	INB	Input channel B	(Reference Circuit 1)
4	VL	Low voltage input pin	
5	GND	Input logic ground	
6	NC	No connection	
7	INC	Input channel C	(Reference Circuit 1)
8	IND	Input channel D	(Reference Circuit 1)
9	VS-	Negative supply voltage	
10	OUTD	Output channel D	<p style="text-align: center;">Circuit 2</p>
11	OUTC	Output channel C	(Reference Circuit 2)
12	VH	High voltage input pin	
13	NC	No connection	
14	OUTB	Output channel B	(Reference Circuit 2)
15	OUTA	Output channel A	(Reference Circuit 2)
16	VS+	Positive supply voltage	

EL7457C

40MHz Non-Inverting Quad CMOS Driver

EL7457C

Block Diagram

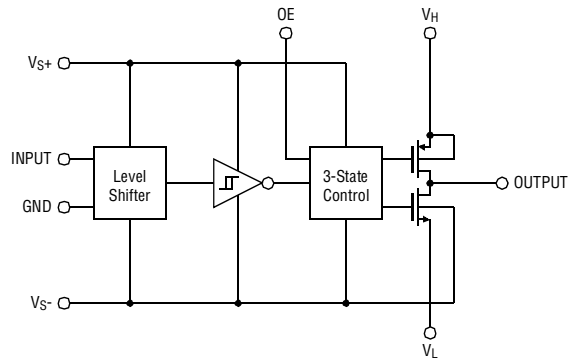

EL7457C

40MHz Non-Inverting Quad CMOS Driver

Applications Information

Product Description

The EL7457C is a high performance 40MHz high speed quad driver. Each channel of the EL7457C consists of a single P-channel high side driver and a single N-channel low side driver. These 3Ω devices will pull the output (OUT_X) to either the high or low voltage, on V_H and V_L respectively, depending on the input logic signal (IN_X). It should be noted that there is only one set of high and low voltage pins.

A common output enable (OE) pin is available on the EL7457C. This pin, when pulled low will put all outputs in to the high impedance state.

The EL7457C is available in both the 16-pin SO (0.150") and the space saving 16-pin QSOP packages. The relevant package should be chosen depending on the calculated power dissipation.

Supply Voltage Range and Input Compatibility

The EL7457C is designed for operation on supplies from 5V to 15V with 10% tolerance (i.e. 4.5V to 16.5V). The table on page 6 shows the specifications for the relationship between the V_{S+}, V_{S-}, V_H, V_L, and GND pins. The EL7457C does not contain a true analog switch and therefore V_L should always be less than V_H.

All input pins are compatible with both 3V and 5V CMOS signals. With a positive supply (V_{S+}) of 5V, the EL7457C is also compatible with TTL inputs.

Power Supply Bypassing

When using the EL7457C, it is very important to use adequate power supply bypassing. The high switching currents developed by the EL7457C necessitate the use of a bypass capacitor on both the positive and negative supplies. It is recommended that a 4.7μF tantalum capacitor be used in parallel with a 0.1μF low-inductance ceramic MLC capacitor. These should be placed as close to the supply pins as possible. It is also recommended that the V_H and V_L pins have some level of bypassing, especially if the EL7457C is driving highly capacitive loads.

Power Dissipation Calculation

When switching at high speeds, or driving heavy loads, the EL7457C drive capability is limited by the rise in die temperature brought about by internal power dissipation. For reliable operation die temperature must be kept below T_{JMAX} (125°C). It is necessary to calculate the power dissipation for a given application prior to selecting package type.

Power dissipation may be calculated:

$$PD = (V_S \times I_S) + \sum_1^4 (C_{INT} \times V_S^2 \times f) + (C_L \times V_{OUT}^2 \times f)$$

where:

V_S is the total power supply to the EL7457C (from V_{S+} to V_{S-})

V_{OUT} is the swing on the output (V_H - V_L)

C_L is the load capacitance

C_{INT} is the internal load capacitance (80pF max)

I_S is the quiescent supply current (3mA max)

f is frequency

Having obtained the application's power dissipation, the maximum junction temperature can be calculated:

$$T_{JMAX} = T_{MAX} + \Theta_{JA} \times PD$$

where:

T_{JMAX} is the maximum junction temperature (125°C)

T_{MAX} is the maximum ambient operating temperature

PD is the power dissipation calculated above

Θ_{JA} is the thermal resistance, junction to ambient, of the application (package + PCB combination). Refer to the Package Power Dissipation curves on page 5

EL7457C

40MHz Non-Inverting Quad CMOS Driver

General Disclaimer

Specifications contained in this data sheet are in effect as of the publication date shown. Elantec, Inc. reserves the right to make changes in the circuitry or specifications contained herein at any time without notice. Elantec, Inc. assumes no responsibility for the use of any circuits described herein and makes no representations that they are free from patent infringement.

élantec

HIGH PERFORMANCE ANALOG INTEGRATED CIRCUITS

Elantec Semiconductor, Inc.

675 Trade Zone Blvd.
Milpitas, CA 95035
Telephone: (408) 945-1323
(888) ELANTEC
Fax: (408) 945-9305
European Office: +44-118-977-6020
Japan Technical Center: +81-45-682-5820

WARNING - Life Support Policy

Elantec, Inc. products are not authorized for and should not be used within Life Support Systems without the specific written consent of Elantec, Inc. Life Support systems are equipment intended to support or sustain life and whose failure to perform when properly used in accordance with instructions provided can be reasonably expected to result in significant personal injury or death. Users contemplating application of Elantec, Inc. Products in Life Support Systems are requested to contact Elantec, Inc. factory headquarters to establish suitable terms & conditions for these applications. Elantec, Inc.'s warranty is limited to replacement of defective components and does not cover injury to persons or property or other consequential damages.