

IR2130/IR2132(J)(S) & (PbF)

3-PHASE BRIDGE DRIVER

Features

- Floating channel designed for bootstrap operation
 Fully operational to +600V
 Tolerant to negative transient voltage
 dV/dt immune
- Gate drive supply range from 10 to 20V
- Undervoltage lockout for all channels
- Over-current shutdown turns off all six drivers
- Independent half-bridge drivers
- Matched propagation delay for all channels
- 2.5V logic compatible
- Outputs out of phase with inputs
- Cross-conduction prevention logic
- Also available LEAD-FREE

Description

The IR2130/IR2132(J)(S) is a high voltage, high speed power MOSFET and IGBT driver with three independent high and low side referenced output channels. Proprietary HVIC technology enables ruggedized monolithic construction. Logic inputs are compatible with CMOS or LSTTL outputs, down to 2.5V logic. A ground-referenced operational amplifier provides analog feedback of bridge current via an external current sense resistor. A current trip function which terminates all six outputs is also derived from this resistor. An open drain $\overline{\text{FAULT}}$ signal indicates if an over-current or undervoltage shutdown has occurred. The output drivers feature a high pulse current buffer stage designed for minimum driver cross-conduction. Propagation delays are matched to simplify use at high frequencies. The floating channels can be used to drive N-channel power MOSFETs or IGBTs in the high side configuration which operate up to 600 volts.

Product Summary

V_{OFFSET}	600V max.
$I_{\text{O}+/-}$	200 mA / 420 mA
V_{OUT}	10 - 20V
$t_{\text{on/off}}$ (typ.)	675 & 425 ns
Deadtime (typ.)	2.5 μs (IR2130) 0.8 μs (IR2132)

Packages

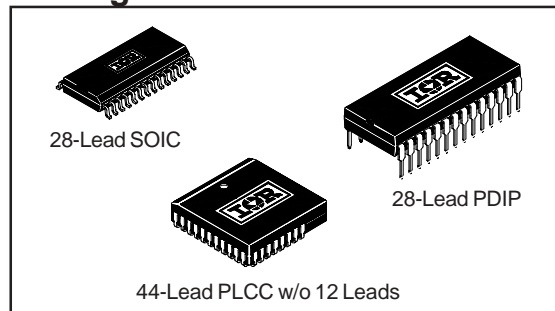

Typical Connection

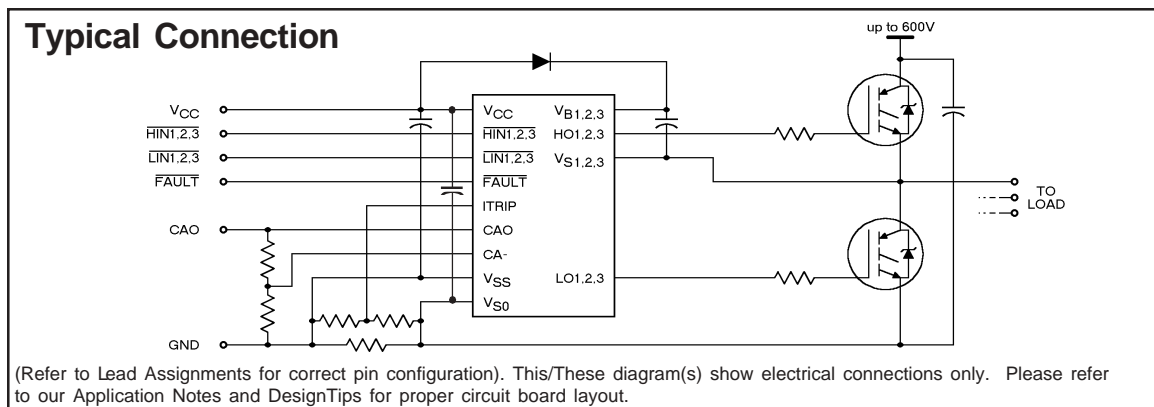

IR2130/IR2132(J)(S) & (PbF)

International
IR Rectifier

Absolute Maximum Ratings

Absolute Maximum Ratings indicate sustained limits beyond which damage to the device may occur. All voltage parameters are absolute voltages referenced to V_{S0} . The Thermal Resistance and Power Dissipation ratings are measured under board mounted and still air conditions. Additional information is shown in Figures 50 through 53.

Symbol	Definition	Min.	Max.	Units		
$V_{B1,2,3}$	High Side Floating Supply Voltage	-0.3	625	V		
$V_{S1,2,3}$	High Side Floating Offset Voltage	$V_{B1,2,3} - 25$	$V_{B1,2,3} + 0.3$			
$V_{HO1,2,3}$	High Side Floating Output Voltage	$V_{S1,2,3} - 0.3$	$V_{B1,2,3} + 0.3$			
V_{CC}	Low Side and Logic Fixed Supply Voltage	-0.3	25			
V_{SS}	Logic Ground	$V_{CC} - 25$	$V_{CC} + 0.3$			
$V_{LO1,2,3}$	Low Side Output Voltage	-0.3	$V_{CC} + 0.3$			
V_{IN}	Logic Input Voltage (HIN1,2,3, LIN1,2,3 & ITRIP)	$V_{SS} - 0.3$	($V_{SS} + 15$) or ($V_{CC} + 0.3$) whichever is lower			
V_{FLT}	FAULT Output Voltage	$V_{SS} - 0.3$	$V_{CC} + 0.3$			
V_{CAO}	Operational Amplifier Output Voltage	$V_{SS} - 0.3$	$V_{CC} + 0.3$			
V_{CA-}	Operational Amplifier Inverting Input Voltage	$V_{SS} - 0.3$	$V_{CC} + 0.3$			
dVs/dt	Allowable Offset Supply Voltage Transient	—	50		V/ns	
P_D	Package Power Dissipation @ $T_A \leq +25^\circ\text{C}$	(28 Lead DIP)	—		1.5	W
		(28 Lead SOIC)	—		1.6	
		(44 Lead PLCC)	—	2.0		
R_{thJA}	Thermal Resistance, Junction to Ambient	(28 Lead DIP)	—	83	$^\circ\text{C/W}$	
		(28 Lead SOIC)	—	78		
		(44 Lead PLCC)	—	63		
T_J	Junction Temperature	—	150	$^\circ\text{C}$		
T_S	Storage Temperature	-55	150			
T_L	Lead Temperature (Soldering, 10 seconds)	—	300			

Recommended Operating Conditions

The Input/Output logic timing diagram is shown in Figure 1. For proper operation the device should be used within the recommended conditions. All voltage parameters are absolute voltages referenced to V_{S0} . The V_S offset rating is tested with all supplies biased at 15V differential. Typical ratings at other bias conditions are shown in Figure 54.

Symbol	Definition	Min.	Max.	Units
$V_{B1,2,3}$	High Side Floating Supply Voltage	$V_{S1,2,3} + 10$	$V_{S1,2,3} + 20$	V
$V_{S1,2,3}$	High Side Floating Offset Voltage	Note 1	600	
$V_{HO1,2,3}$	High Side Floating Output Voltage	$V_{S1,2,3}$	$V_{B1,2,3}$	
V_{CC}	Low Side and Logic Fixed Supply Voltage	10	20	
V_{SS}	Logic Ground	-5	5	
$V_{LO1,2,3}$	Low Side Output Voltage	0	V_{CC}	
V_{IN}	Logic Input Voltage (HIN1,2,3, LIN1,2,3 & ITRIP)	V_{SS}	$V_{SS} + 5$	
V_{FLT}	FAULT Output Voltage	V_{SS}	V_{CC}	
V_{CAO}	Operational Amplifier Output Voltage	V_{SS}	$V_{SS} + 5$	
V_{CA-}	Operational Amplifier Inverting Input Voltage	V_{SS}	$V_{SS} + 5$	
T_A	Ambient Temperature	-40	125	$^\circ\text{C}$

Note 1: Logic operational for V_S of ($V_{S0} - 5V$) to ($V_{S0} + 600V$). Logic state held for V_S of ($V_{S0} - 5V$) to ($V_{S0} - V_{BS}$). (Please refer to the Design Tip DT97-3 for more details).

Note 2: All input pins, CA- and CAO pins are internally clamped with a 5.2V zener diode.

Dynamic Electrical Characteristics

V_{BIAS} (V_{CC} , $V_{BS1,2,3}$) = 15V, $V_{S0,1,2,3}$ = V_{SS} , C_L = 1000 pF and T_A = 25°C unless otherwise specified. The dynamic electrical characteristics are defined in Figures 3 through 5.

Symbol	Definition	Figure	Min.	Typ.	Max.	Units	Test Conditions
t_{on}	Turn-On Propagation Delay	11	500	675	850	ns	
t_{off}	Turn-Off Propagation Delay	12	300	425	550		$V_{IN} = 0$ & 5V
t_r	Turn-On Rise Time	13	—	80	125		$V_{S1,2,3} = 0$ to 600V
t_f	Turn-Off Fall Time	14	—	35	55		
t_{itrip}	ITRIP to Output Shutdown Prop. Delay	15	400	660	920		V_{IN} , $V_{ITRIP} = 0$ & 5V
t_{bl}	ITRIP Blanking Time	—	—	400	—		$V_{ITRIP} = 1V$
t_{flt}	ITRIP to \overline{FAULT} Indication Delay	16	335	590	845		V_{IN} , $V_{ITRIP} = 0$ & 5V
$t_{flt.in}$	Input Filter Time (All Six Inputs)	—	—	310	—		$V_{IN} = 0$ & 5V
t_{fltclr}	LIN1,2,3 to \overline{FAULT} Clear Time	17	6.0	9.0	12.0		V_{IN} , $V_{ITRIP} = 0$ & 5V
DT	Deadtime (IR2130)	18	1.3	2.5	3.7		μs
	(IR2132)	18	0.4	0.8	1.2		
SR+	Operational Amplifier Slew Rate (+)	19	4.4	6.2	—	V/ μs	
SR-	Operational Amplifier Slew Rate (-)	20	2.4	3.2	—		

NOTE: For high side PWM, HIN pulse width must be $\geq 1.5\mu s$

Static Electrical Characteristics

V_{BIAS} (V_{CC} , $V_{BS1,2,3}$) = 15V, $V_{S0,1,2,3}$ = V_{SS} and T_A = 25°C unless otherwise specified. The V_{IN} , V_{TH} and I_{IN} parameters are referenced to V_{SS} and are applicable to all six logic input leads: HIN1,2,3 & LIN1,2,3. The V_O and I_O parameters are referenced to $V_{S0,1,2,3}$ and are applicable to the respective output leads: HO1,2,3 or LO1,2,3.

Symbol	Definition	Figure	Min.	Typ.	Max.	Units	Test Conditions
V_{IH}	Logic "0" Input Voltage (OUT = LO)	21	2.2	—	—	V	
V_{IL}	Logic "1" Input Voltage (OUT = HI)	22	—	—	0.8		
$V_{IT,TH+}$	ITRIP Input Positive Going Threshold	23	400	490	580	mV	
V_{OH}	High Level Output Voltage, $V_{BIAS} - V_O$	24	—	—	100		$V_{IN} = 0V$, $I_O = 0A$
V_{OL}	Low Level Output Voltage, V_O	25	—	—	100	$V_{IN} = 5V$, $I_O = 0A$	
I_{LK}	Offset Supply Leakage Current	26	—	—	50	μA	$V_B = V_S = 600V$
I_{QBS}	Quiescent V_{BS} Supply Current	27	—	15	30		$V_{IN} = 0V$ or 5V
I_{QCC}	Quiescent V_{CC} Supply Current	28	—	3.0	4.0	mA	$V_{IN} = 0V$ or 5V
I_{IN+}	Logic "1" Input Bias Current (OUT = HI)	29	—	450	650		$V_{IN} = 0V$
I_{IN-}	Logic "0" Input Bias Current (OUT = LO)	30	—	225	400	μA	$V_{IN} = 5V$
I_{ITRIP+}	"High" ITRIP Bias Current	31	—	75	150		ITRIP = 5V
I_{ITRIP-}	"Low" ITRIP Bias Current	32	—	—	100	nA	ITRIP = 0V
V_{BSUV+}	V_{BS} Supply Undervoltage Positive Going Threshold	33	7.5	8.35	9.2	V	
V_{BSUV-}	V_{BS} Supply Undervoltage Negative Going Threshold	34	7.1	7.95	8.8		
V_{CCUV+}	V_{CC} Supply Undervoltage Positive Going Threshold	35	8.3	9.0	9.7		
V_{CCUV-}	V_{CC} Supply Undervoltage Negative Going Threshold	36	8.0	8.7	9.4		
$R_{on,FLT}$	\overline{FAULT} Low On-Resistance	37	—	55	75		Ω

IR2130/IR2132(J)(S) & (PbF)

International
IR Rectifier

Static Electrical Characteristics -- Continued

V_{BIAS} (V_{CC} , $V_{BS1,2,3}$) = 15V, $V_{S0,1,2,3}$ = V_{SS} and T_A = 25°C unless otherwise specified. The V_{IN} , V_{TH} and I_{IN} parameters are referenced to V_{SS} and are applicable to all six logic input leads: $HIN1,2,3$ & $LIN1,2,3$. The V_O and I_O parameters are referenced to $V_{S0,1,2,3}$ and are applicable to the respective output leads: $HO1,2,3$ or $LO1,2,3$.

Symbol	Definition	Figure	Min.	Typ.	Max.	Units	Test Conditions
I_{O+}	Output High Short Circuit Pulsed Current	38	200	250	—	mA	$V_O = 0V$, $V_{IN} = 0V$ $PW \leq 10 \mu s$
I_{O-}	Output Low Short Circuit Pulsed Current	39	420	500	—		$V_O = 15V$, $V_{IN} = 5V$ $PW \leq 10 \mu s$
V_{OS}	Operational Amplifier Input Offset Voltage	40	—	—	30	mV	$V_{S0} = V_{CA-} = 0.2V$
I_{CA-}	CA- Input Bias Current	41	—	—	4.0	nA	$V_{CA-} = 2.5V$
CMRR	Op. Amp. Common Mode Rejection Ratio	42	60	80	—	dB	$V_{S0} = V_{CA-} = 0.1V$ & $5V$
PSRR	Op. Amp. Power Supply Rejection Ratio	43	55	75	—		$V_{S0} = V_{CA-} = 0.2V$ $V_{CC} = 10V$ & $20V$
$V_{OH,AMP}$	Op. Amp. High Level Output Voltage	44	5.0	5.2	5.4	V	$V_{CA-} = 0V$, $V_{S0} = 1V$
$V_{OL,AMP}$	Op. Amp. Low Level Output Voltage	45	—	—	20	mV	$V_{CA-} = 1V$, $V_{S0} = 0V$
$I_{SRC,AMP}$	Op. Amp. Output Source Current	46	2.3	4.0	—	mA	$V_{CA-} = 0V$, $V_{S0} = 1V$ $V_{CA0} = 4V$
$I_{SRC,AMP}$	Op. Amp. Output Sink Current	47	1.0	2.1	—		$V_{CA-} = 1V$, $V_{S0} = 0V$ $V_{CA0} = 2V$
$I_{O+,AMP}$	Operational Amplifier Output High Short Circuit Current	48	—	4.5	6.5		$V_{CA-} = 0V$, $V_{S0} = 5V$ $V_{CA0} = 0V$
$I_{O-,AMP}$	Operational Amplifier Output Low Short Circuit Current	49	—	3.2	5.2		$V_{CA-} = 5V$, $V_{S0} = 0V$ $V_{CA0} = 5V$

Lead Assignments

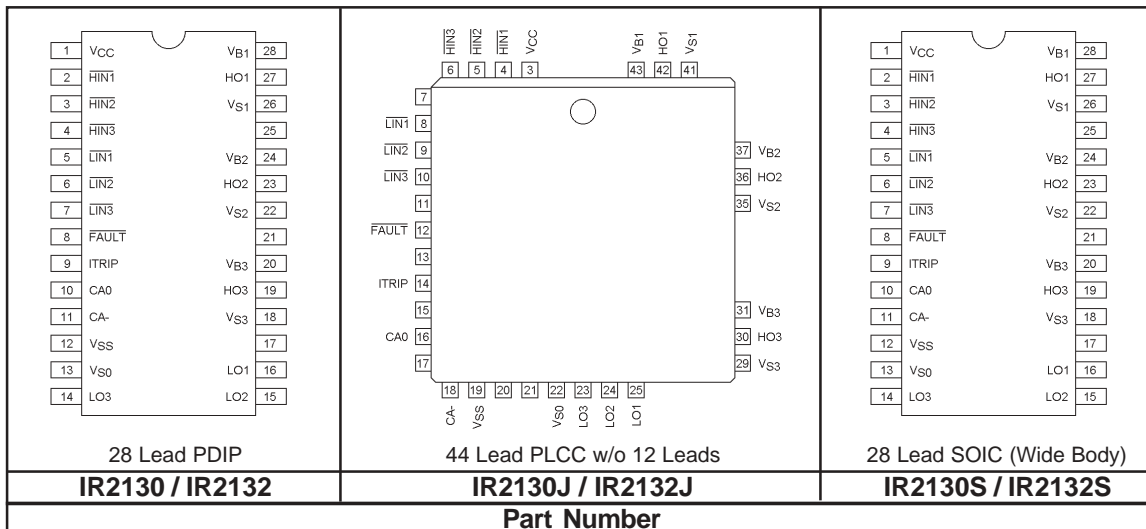

Functional Block Diagram



Lead Definitions

Symbol	Description
HIN1,2,3	Logic inputs for high side gate driver outputs (HO1,2,3), out of phase
LIN1,2,3	Logic inputs for low side gate driver output (LO1,2,3), out of phase
FAULT	Indicates over-current or undervoltage lockout (low side) has occurred, negative logic
VCC	Low side and logic fixed supply
ITRIP	Input for over-current shutdown
CAO	Output of current amplifier
CA-	Negative input of current amplifier
VSS	Logic ground
VB1,2,3	High side floating supplies
HO1,2,3	High side gate drive outputs
VS1,2,3	High side floating supply returns
LO1,2,3	Low side gate drive outputs
VS0	Low side return and positive input of current amplifier

IR2130/IR2132(J)(S) & (PbF)

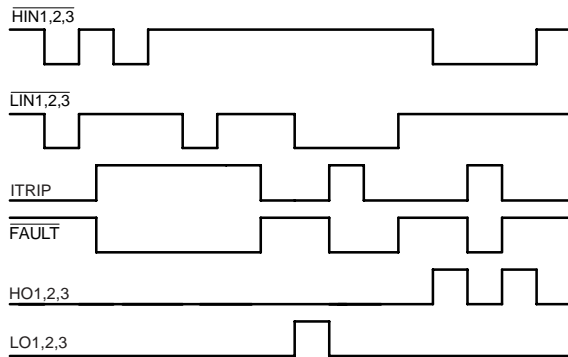

Figure 1. Input/Output Timing Diagram

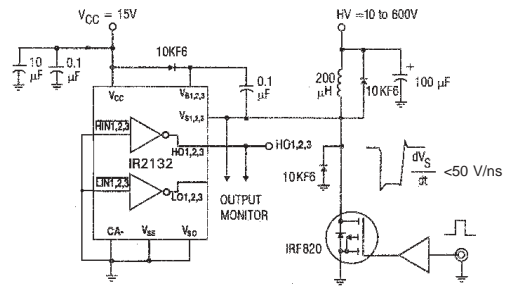

Figure 2. Floating Supply Voltage Transient Test Circuit



Figure 3. Deadtime Waveform Definitions

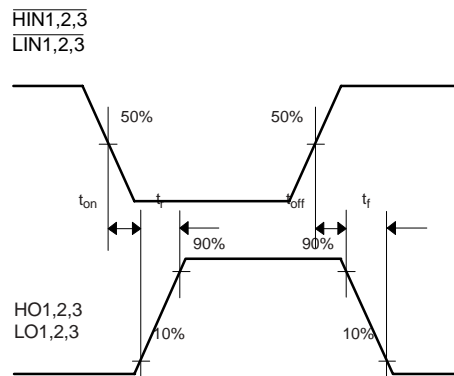

Figure 4. Input/Output Switching Time Waveform Definitions

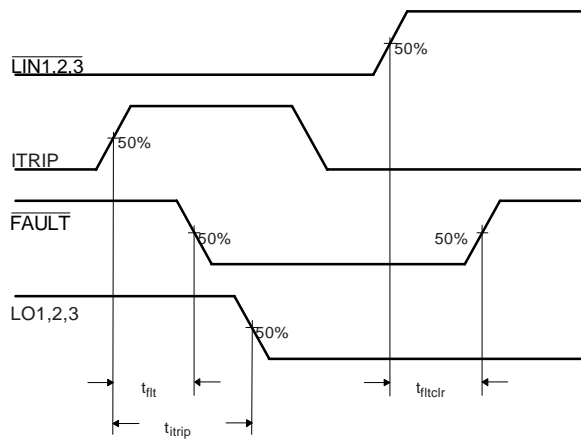

Figure 5. Overcurrent Shutdown Switching Time Waveform Definitions

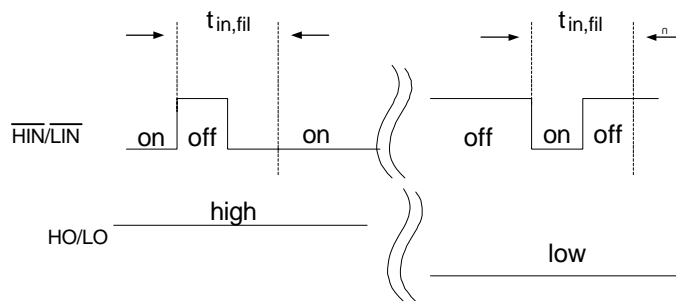

Figure 5.5 Input Filter Function

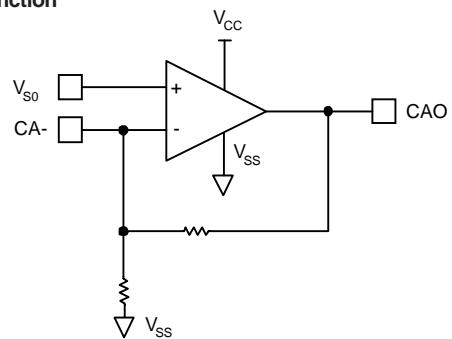

Figure 6. Diagnostic Feedback Operational Amplifier Circuit

IR2130/IR2132(J)(S) & (PbF)

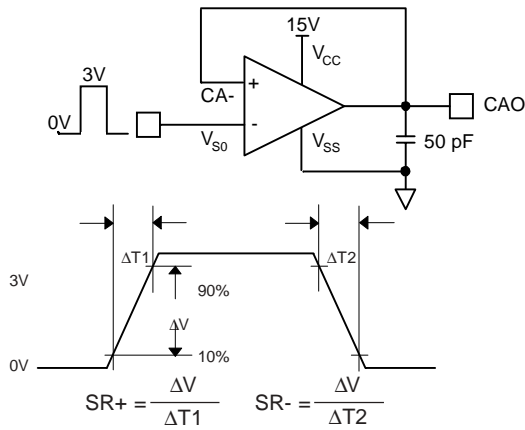

Figure 7. Operational Amplifier Slew Rate Measurement

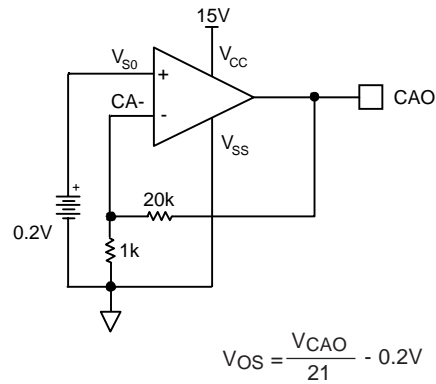

Figure 8. Operational Amplifier Input Offset Voltage Measurement

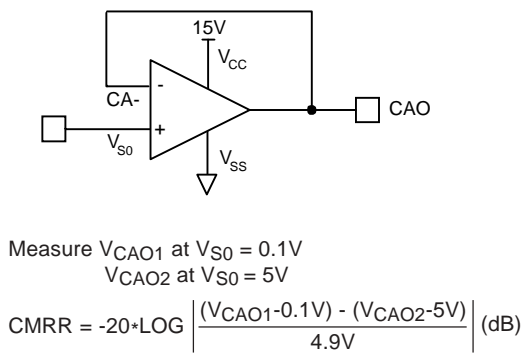

Figure 9. Operational Amplifier Common Mode Rejection Ratio Measurements

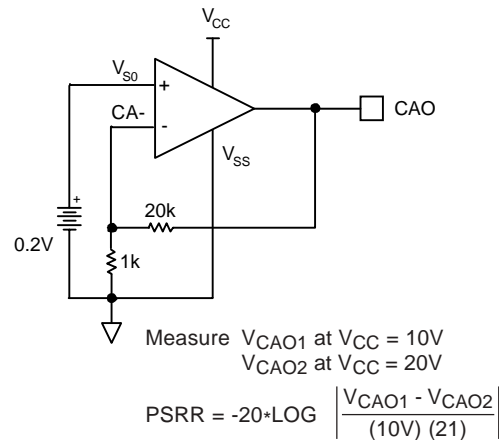

Figure 10. Operational Amplifier Power Supply Rejection Ratio Measurements

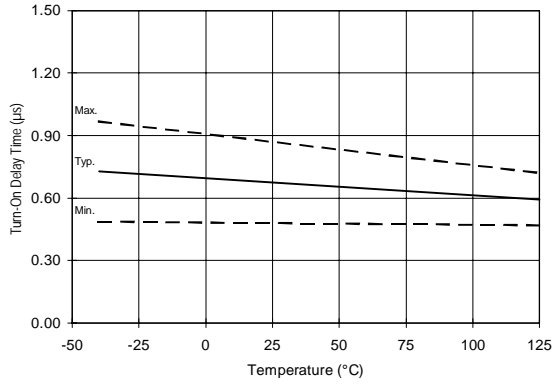

Figure 11A. Turn-On Time vs. Temperature

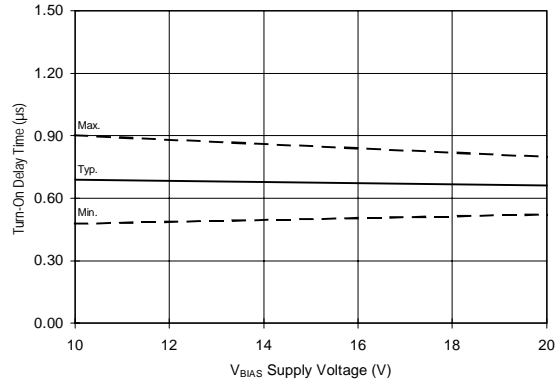

Figure 11B. Turn-On Time vs. Supply Voltage

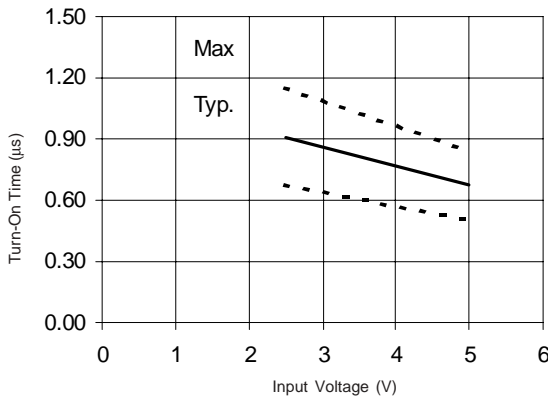

Figure 11C. Turn-On Time vs. Voltage

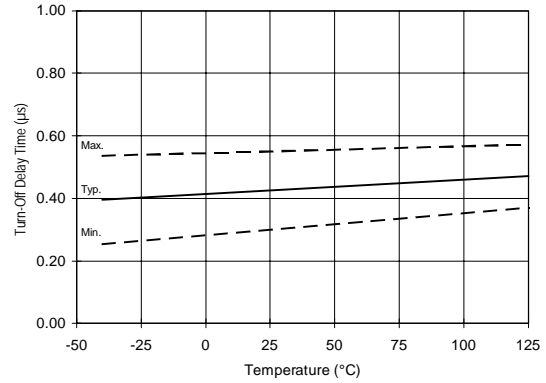

Figure 12A. Turn-Off Time vs. Temperature

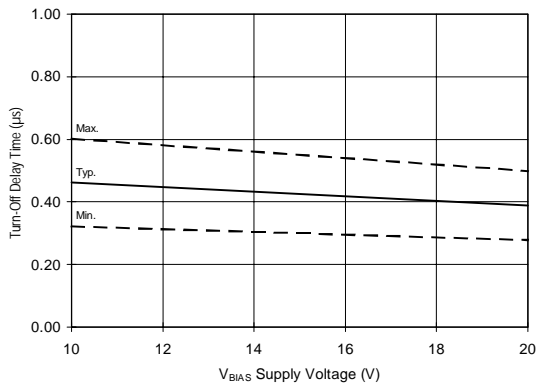

Figure 12B. Turn-Off Time vs. Supply Voltage

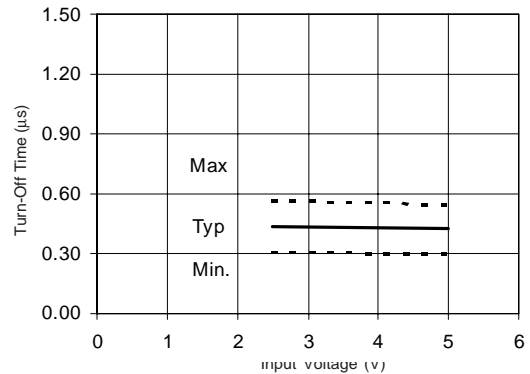

Figure 12C. Turn-Off Time vs. Input Voltage

IR2130/IR2132(J)(S) & (PbF)

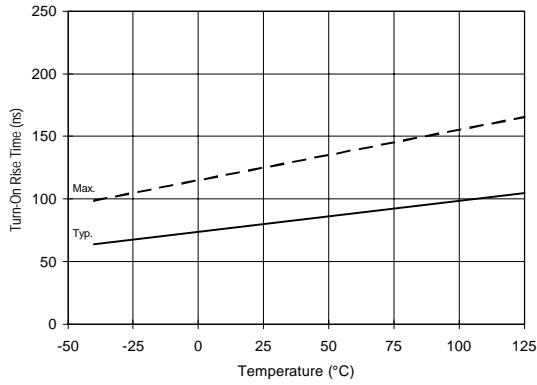

Figure 13A. Turn-On Rise Time vs. Temperature

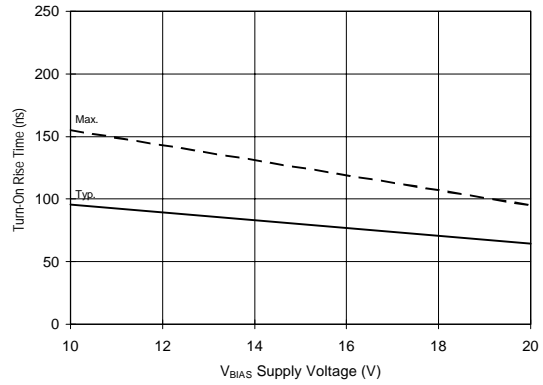

Figure 13B. Turn-On Rise Time vs. Voltage



Figure 14A. Turn-Off Fall Time vs. Temperature

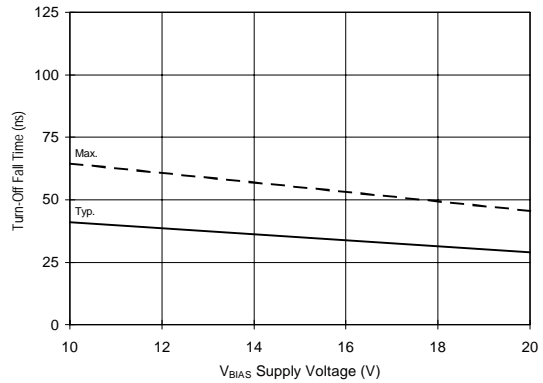

Figure 14B. Turn-Off Fall Time vs. Voltage

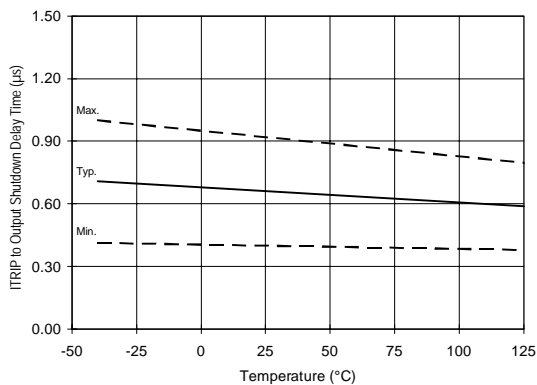

Figure 15A. ITRIP to Output Shutdown Delay Time vs. Temperature

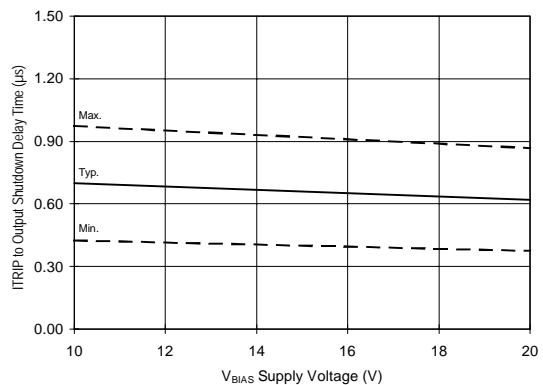

Figure 15B. ITRIP to Output Shutdown Delay Time vs. Voltage



Figure 16A. ITRIP to $\overline{\text{FAULT}}$ Indication Time vs. Temperature

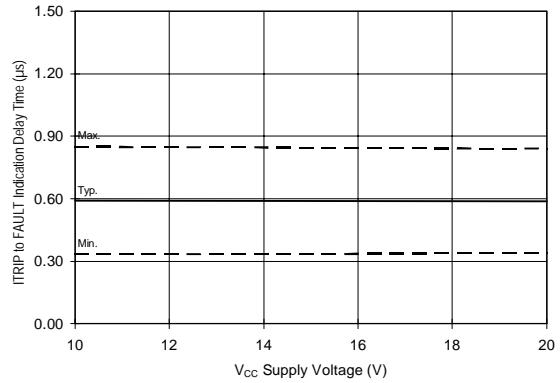

Figure 16B. ITRIP to $\overline{\text{FAULT}}$ Indication Time vs. Voltage



Figure 17A. $\overline{\text{LIN1,2,3}}$ to $\overline{\text{FAULT}}$ Clear Time vs. Temperature

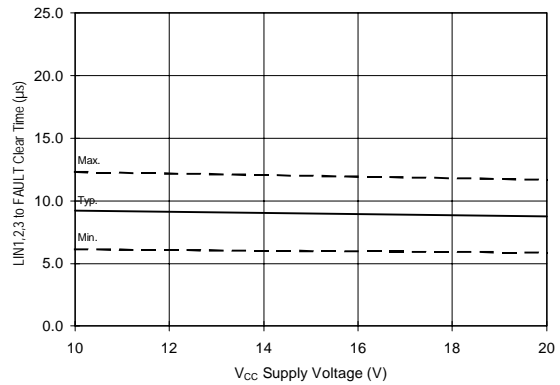

Figure 17B. $\overline{\text{LIN1,2,3}}$ to $\overline{\text{FAULT}}$ Clear Time vs. Voltage

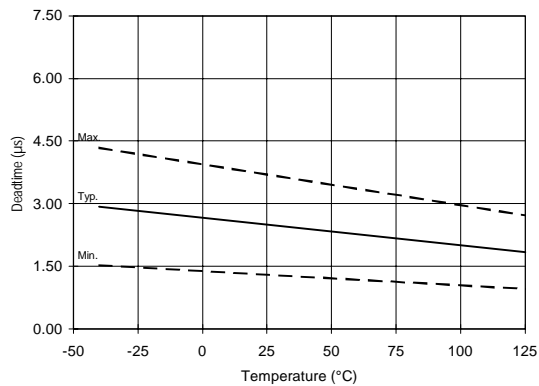

Figure 18A. Deadtime vs. Temperature (IR2130)

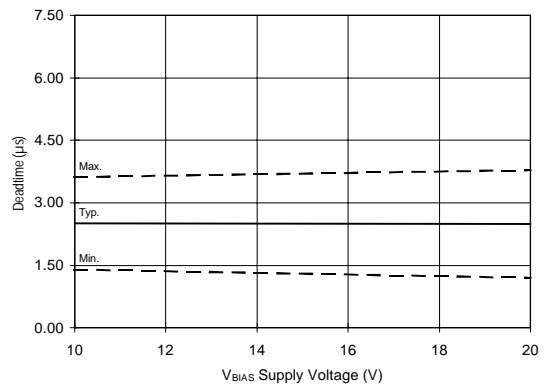

Figure 18B. Deadtime vs. Voltage (IR2130)

IR2130/IR2132(J)(S) & (PbF)

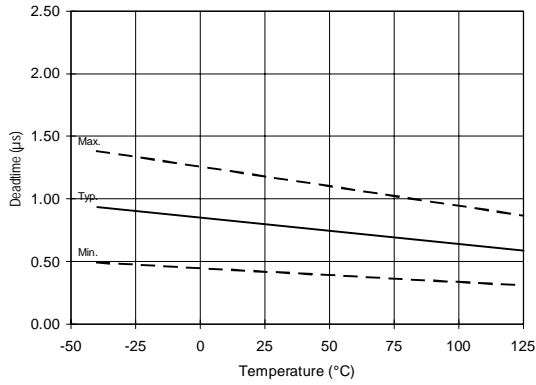

Figure 18C. Deadtime vs. Temperature (IR2132)

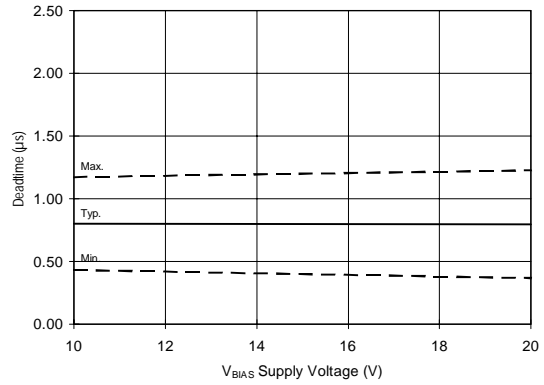

Figure 18D. Deadtime vs. Voltage (IR2132)

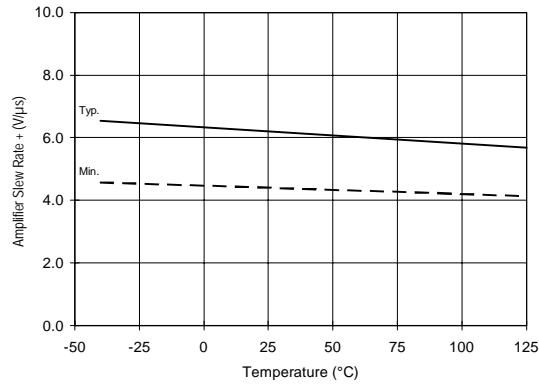

Figure 19A. Amplifier Slew Rate (+) vs. Temperature

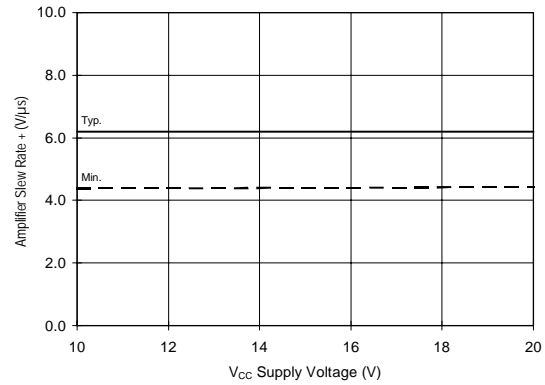

Figure 19B. Amplifier Slew Rate (+) vs. Voltage

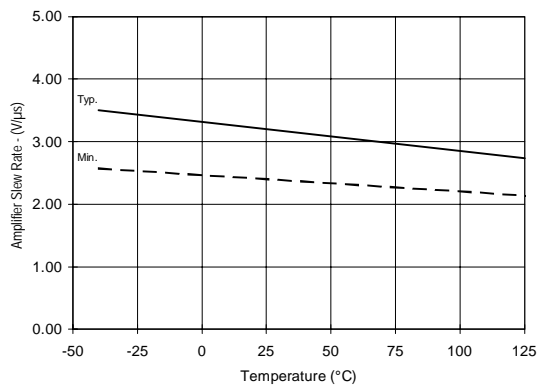

Figure 20A. Amplifier Slew Rate (-) vs. Temperature

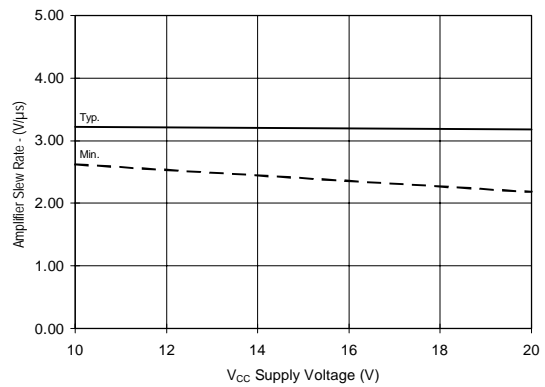

Figure 20B. Amplifier Slew Rate (-) vs. Voltage

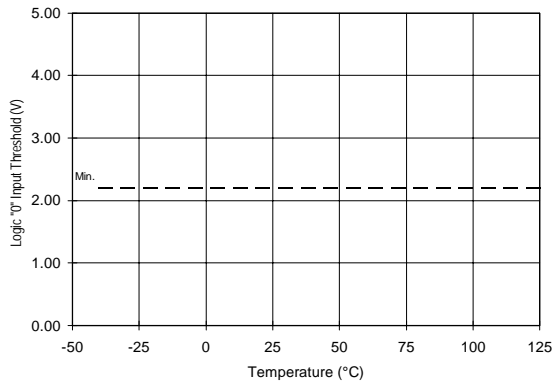

Figure 21A. Logic "0" Input Threshold vs. Temperature

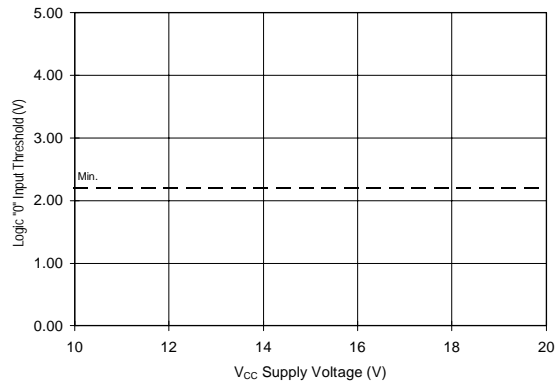

Figure 20B. Logic "0" Input Threshold vs. Voltage

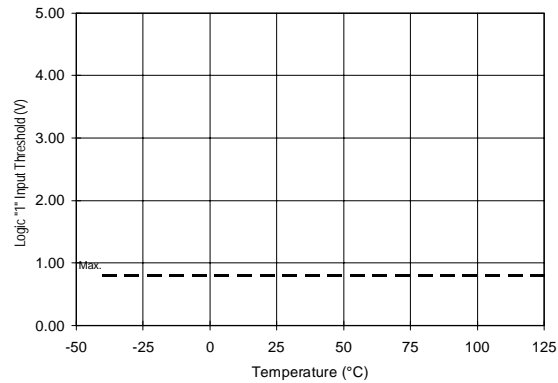

Figure 22A. Logic "1" Input Threshold vs. Temperature

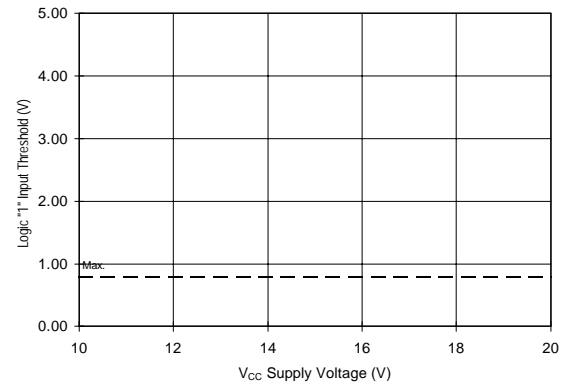

Figure 22B. Logic "1" Input Threshold vs. Voltage

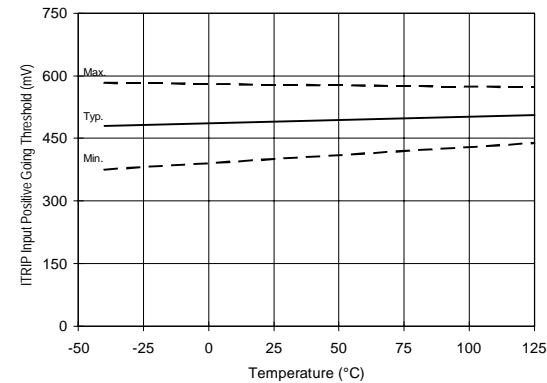

Figure 23A. ITRIP Input Positive Going Threshold vs. Temperature

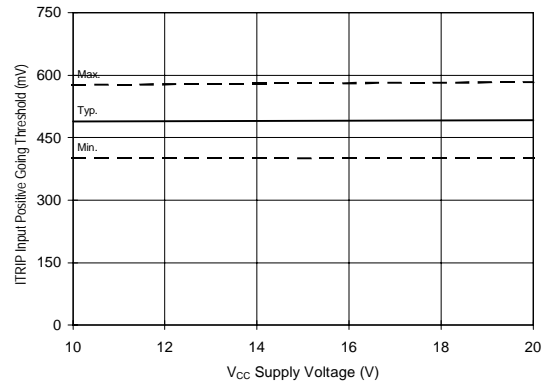

Figure 23B. ITRIP Input Positive Going Threshold vs. Voltage

IR2130/IR2132(J)(S) & (PbF)

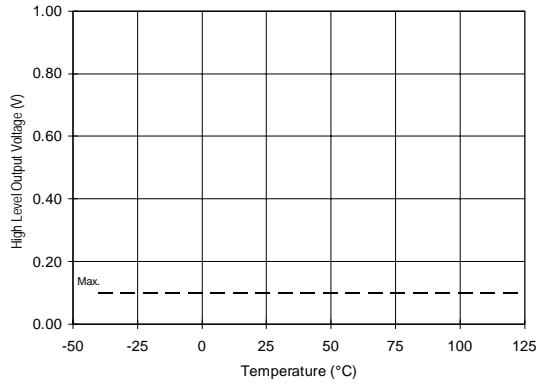

Figure 24A. High Level Output vs. Temperature

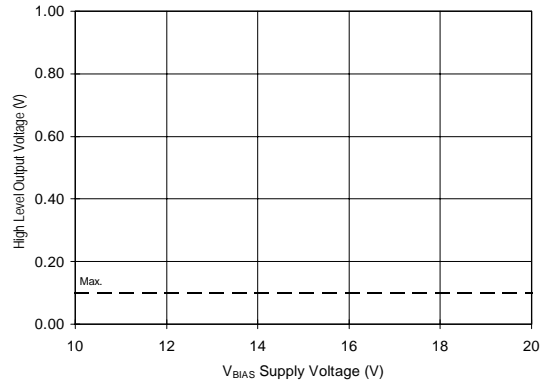

Figure 24B. High Level Output vs. Voltage

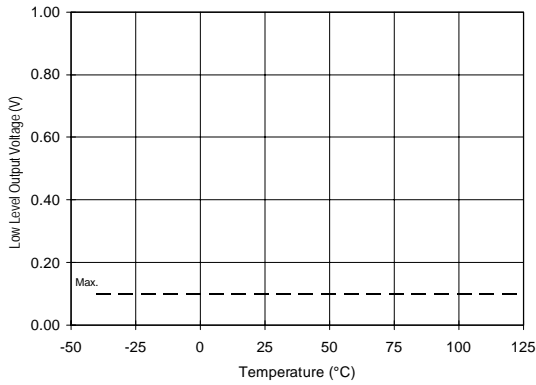

Figure 25A. Low Level Output vs. Temperature

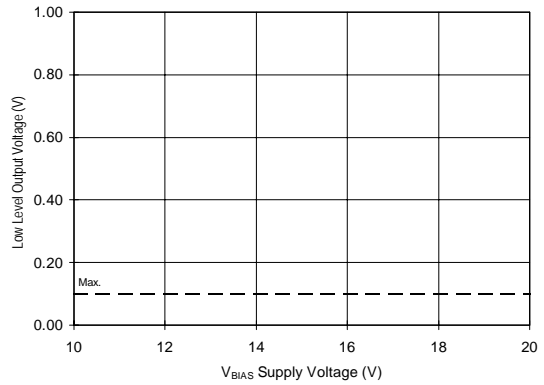

Figure 25B. Low Level Output vs. Voltage

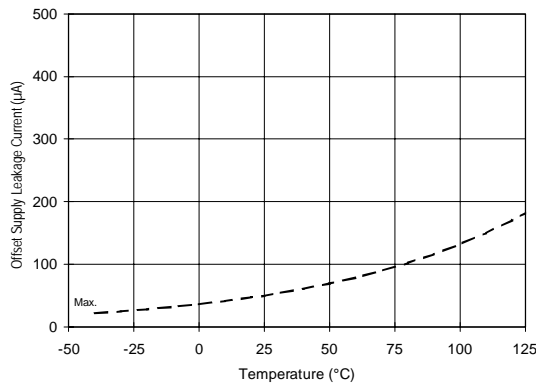

Figure 26A. Offset Supply Leakage Current vs. Temperature

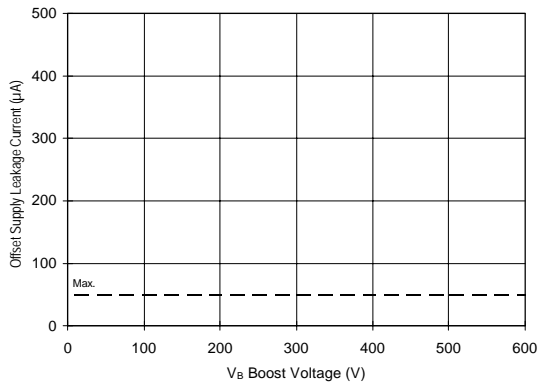

Figure 26B. Offset Supply Leakage Current vs. Voltage

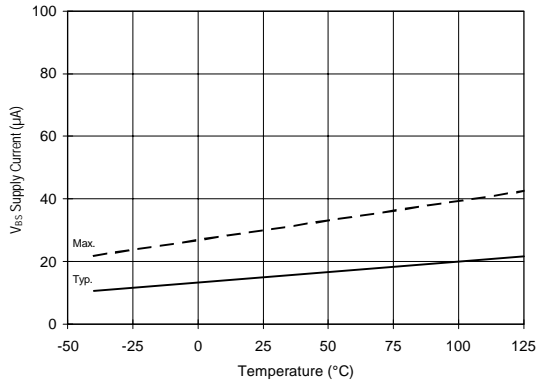

Figure 27A. V_{BS} Supply Current vs. Temperature

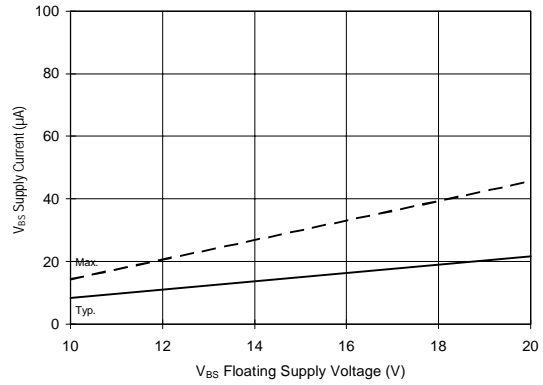

Figure 27B. V_{BS} Supply Current vs. Voltage

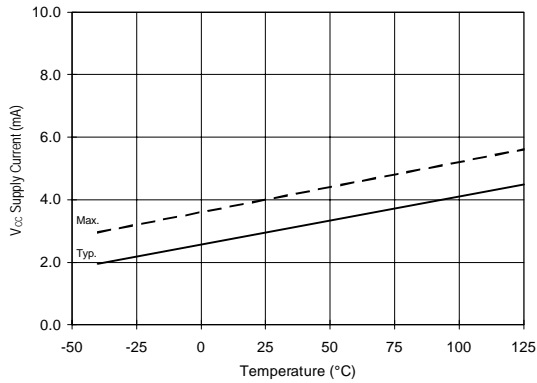

Figure 28A. V_{CC} Supply Current vs. Temperature

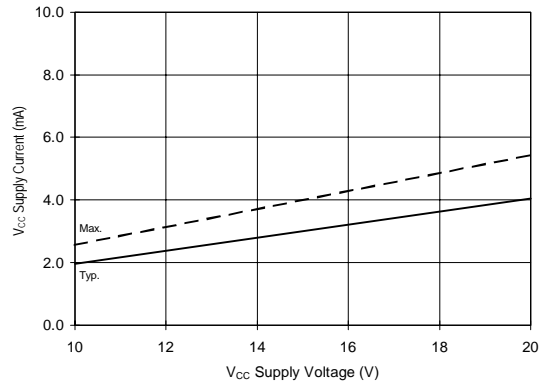

Figure 28B. V_{CC} Supply Current vs. Voltage

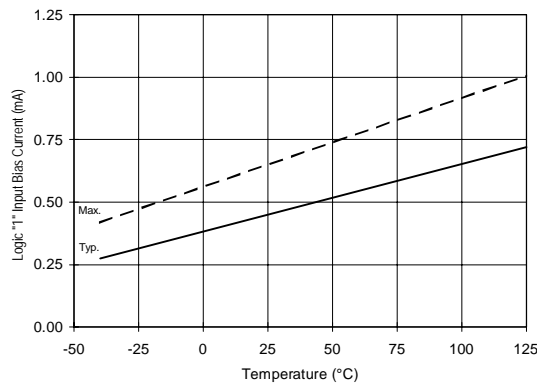

Figure 29A. Logic "1" Input Current vs. Temperature

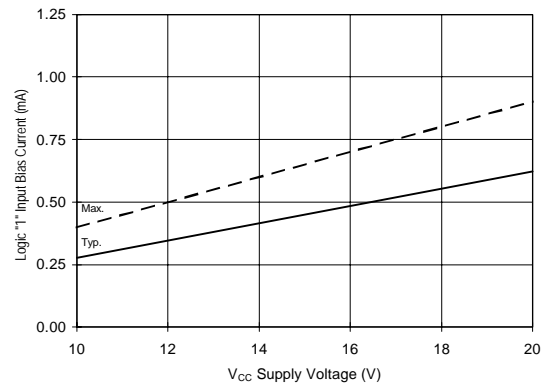

Figure 29B. Logic "1" Input Current vs. Voltage

IR2130/IR2132(J)(S) & (PbF)

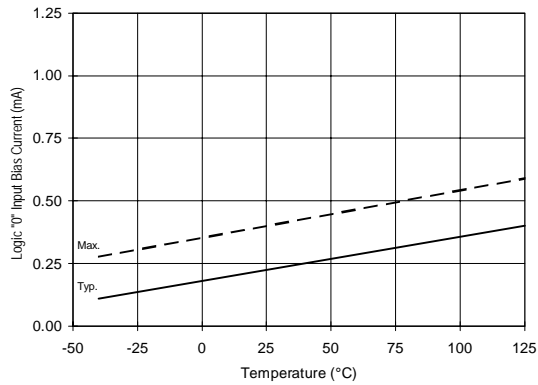

Figure 30A. Logic "0" Input Current vs. Temperature

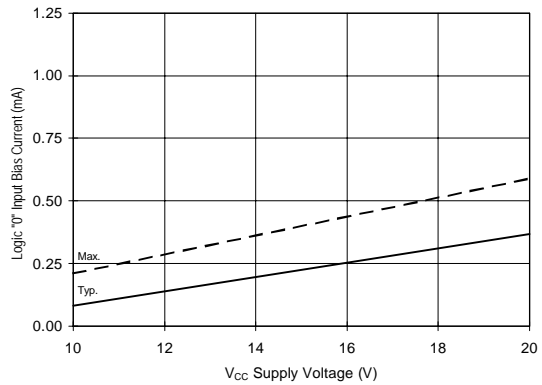

Figure 30B. Logic "0" Input Current vs. Voltage

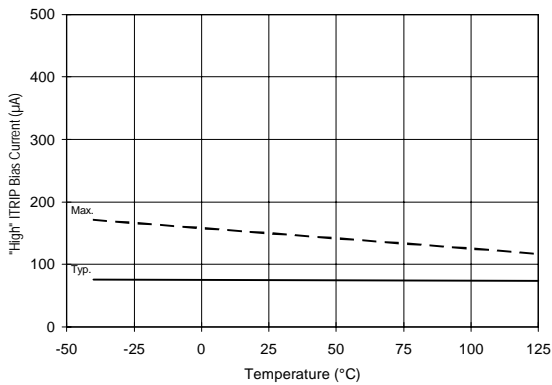

Figure 31A. "High" ITRIP Current vs. Temperature

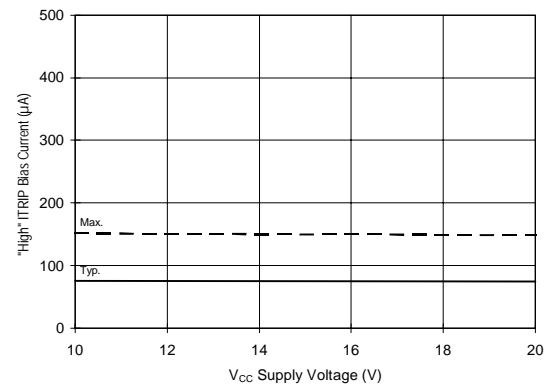

Figure 31B. "High" ITRIP Current vs. Voltage

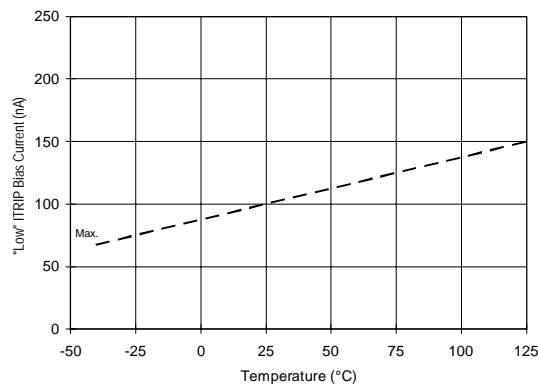

Figure 32A. "Low" ITRIP Current vs. Temperature

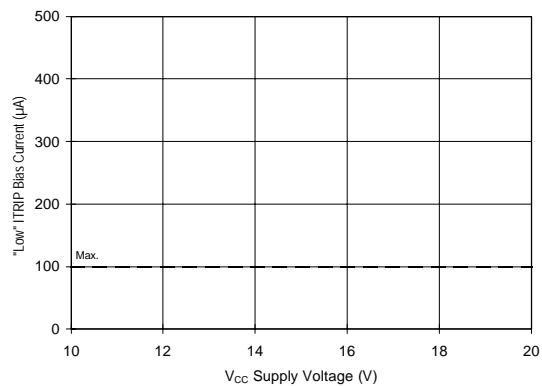

Figure 32B. "Low" ITRIP Current vs. Voltage



Figure 33. V_{BS} Undervoltage (+) vs. Temperature



Figure 34. V_{BS} Undervoltage (-) vs. Temperature

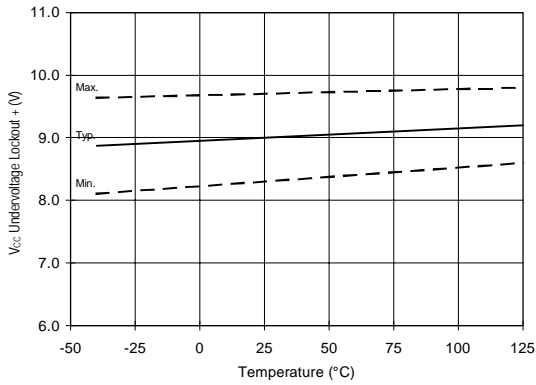

Figure 35. V_{CC} Undervoltage (+) vs. Temperature

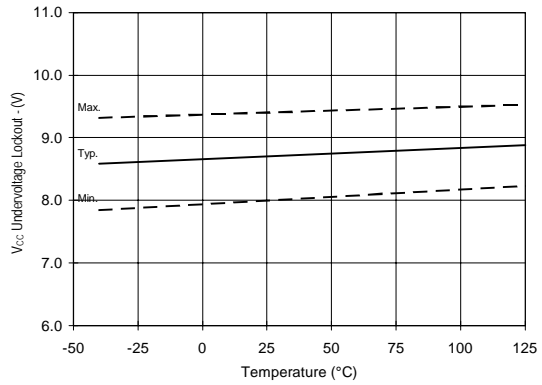

Figure 36. V_{CC} Undervoltage (-) vs. Temperature

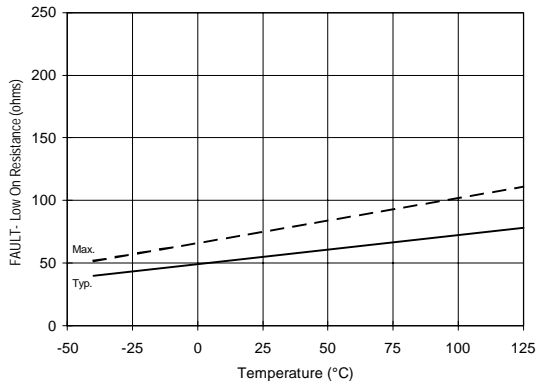

Figure 37A. $\overline{\text{FAULT}}$ Low On Resistance vs. Temperature

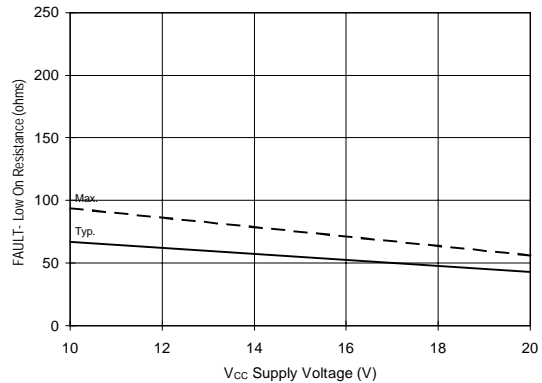

Figure 37B. $\overline{\text{FAULT}}$ Low On Resistance vs. Voltage

IR2130/IR2132(J)(S) & (PbF)



Figure 38A. Output Source Current vs. Temperature



Figure 38B. Output Source Current vs. Voltage

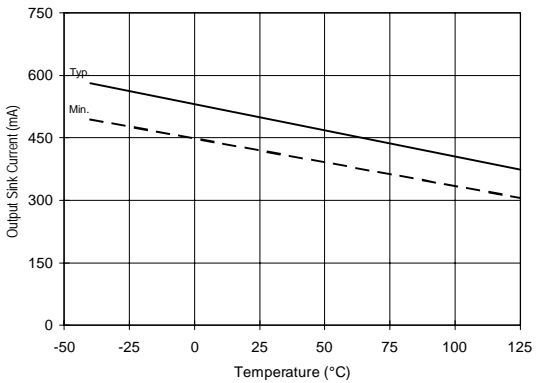

Figure 39A. Output Sink Current vs. Temperature

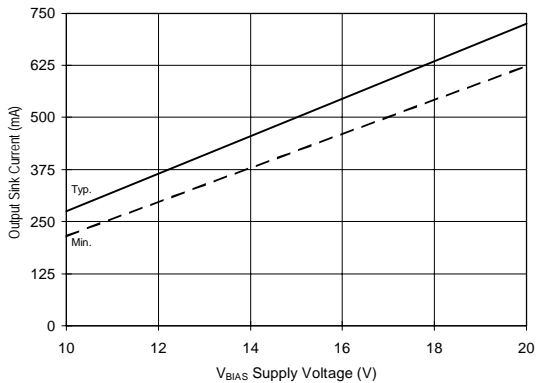

Figure 39B. Output Sink Current vs. Voltage



Figure 40A. Amplifier Input Offset vs. Temperature

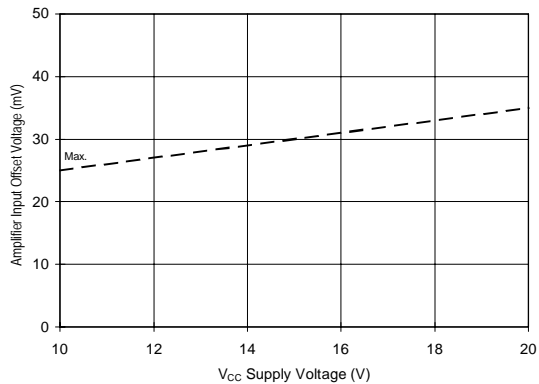

Figure 40B. Amplifier Input Offset vs. Voltage

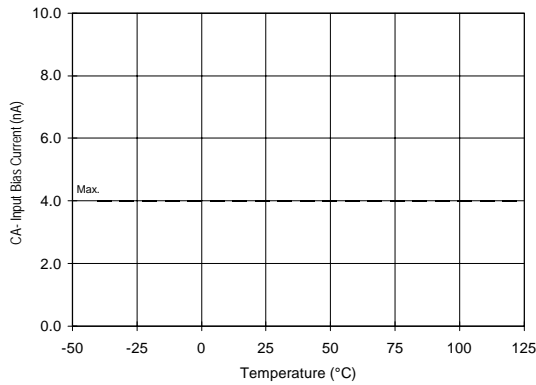

Figure 41A. CA- Input Current vs. Temperature

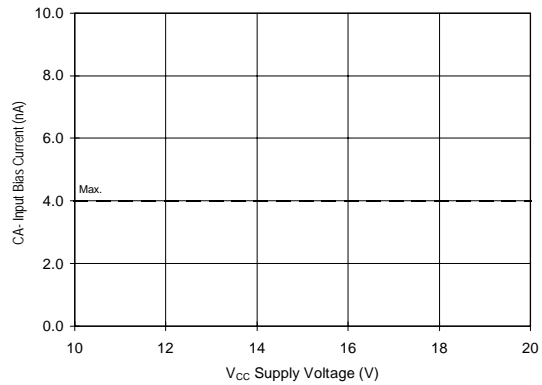

Figure 41B. CA- Input Current vs. Voltage

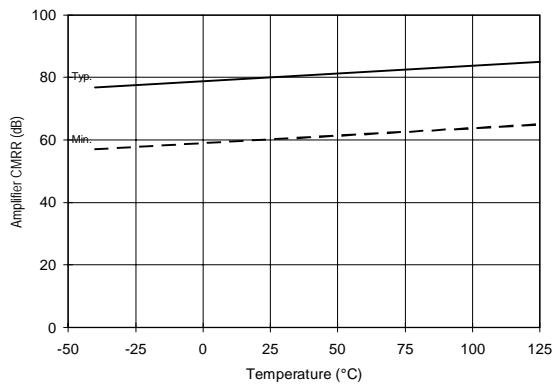

Figure 42A. Amplifier CMRR vs. Temperature

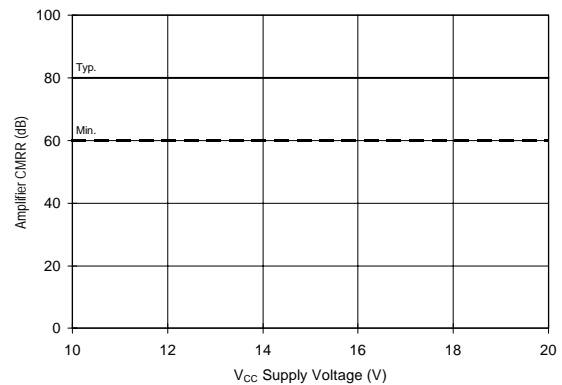

Figure 42B. Amplifier CMRR vs. Voltage

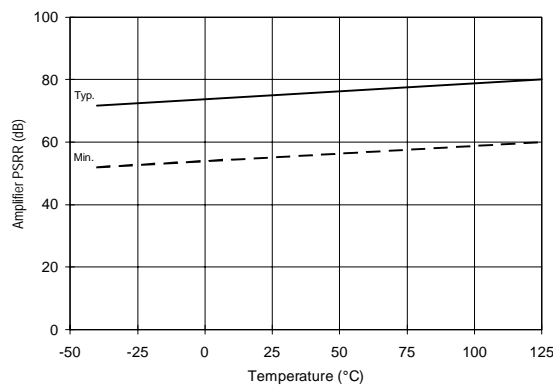

Figure 43A. Amplifier PSRR vs. Temperature

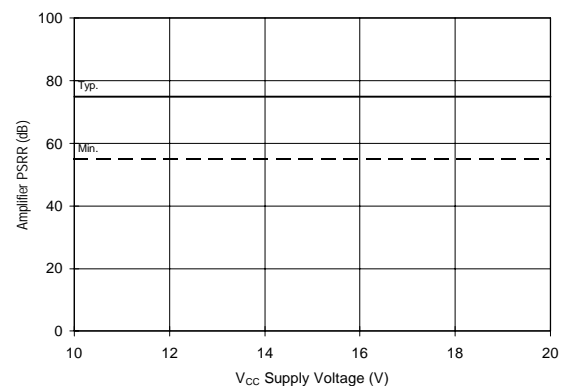

Figure 43B. Amplifier PSRR vs. Voltage

IR2130/IR2132(J)(S) & (PbF)



Figure 44A. Amplifier High Level Output vs. Temperature

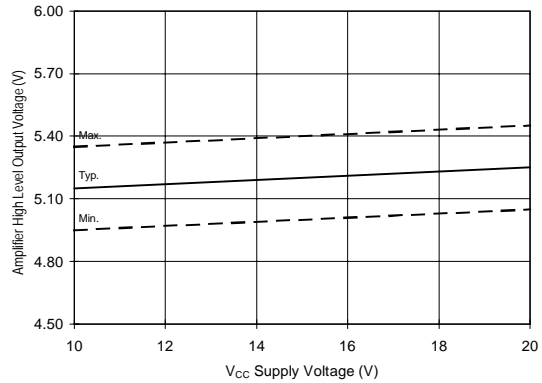

Figure 44B. Amplifier High Level Output vs. Voltage



Figure 45A. Amplifier Low Level Output vs. Temperature

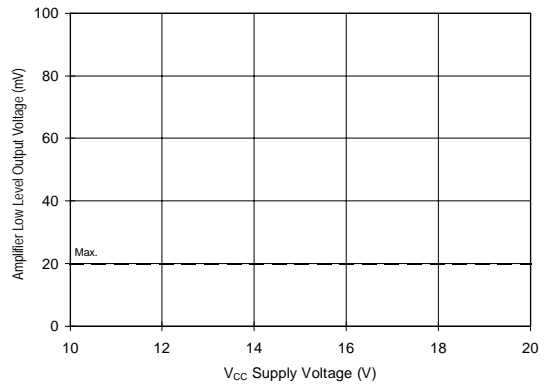

Figure 45B. Amplifier Low Level Output vs. Voltage



Figure 46A. Amplifier Output Source Current vs. Temperature

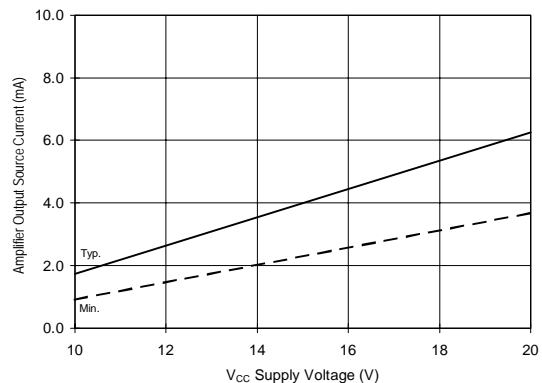

Figure 46B. Amplifier Output Source Current vs. Voltage

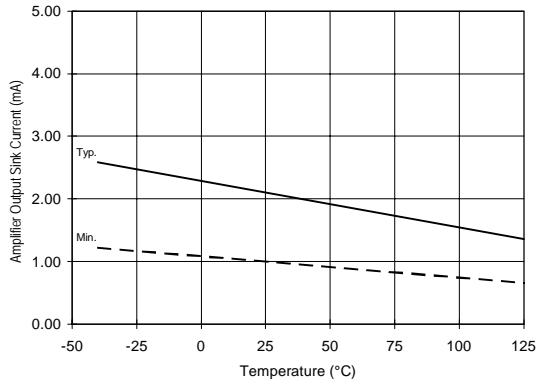

Figure 47A. Amplifier Output Sink Current vs. Temperature

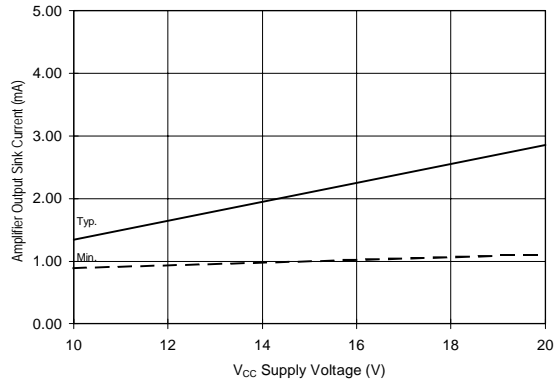

Figure 47B. Amplifier Output Sink Current vs. Voltage

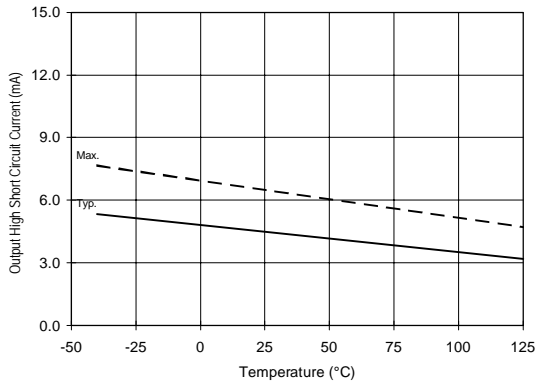

Figure 48A. Amplifier Output High Short Circuit Current vs. Temperature

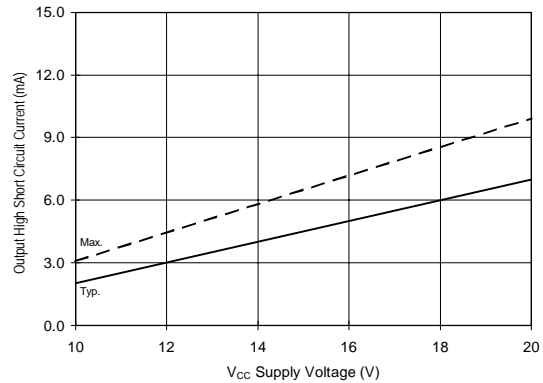

Figure 48B. Amplifier Output High Short Circuit Current vs. Voltage

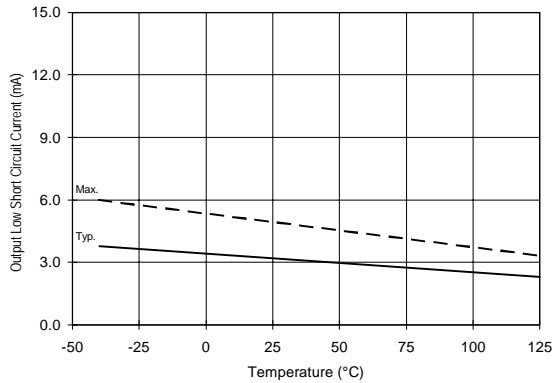

Figure 49A. Amplifier Output Low Short Circuit Current vs. Temperature

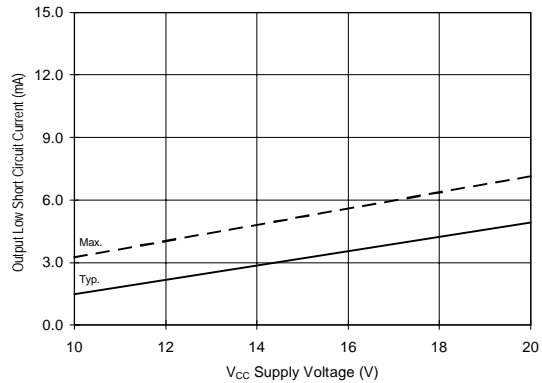

Figure 49B. Amplifier Output Low Short Circuit Current vs. Voltage

IR2130/IR2132(J)(S) & (PbF)



Figure 50. Maximum VS Negative Offset vs. V_{BS} Supply Voltage



Figure 51. IR2130/IR2132 T_J vs. Frequency (IRF820)
R_{GATE} = 33Ω, V_{CC} = 15V



Figure 52. IR2130/IR2132 T_J vs. Frequency (IRF830)
R_{GATE} = 20Ω, V_{CC} = 15V



Figure 53. IR2130/IR2132 T_J vs. Frequency (IRF840)
R_{GATE} = 15Ω, V_{CC} = 15V



Figure 54. IR2130/IR2132 T_J vs. Frequency (IRF450)
R_{GATE} = 10Ω, V_{CC} = 15V

IR2130/IR2132(J)(S) & (PbF)



Figure 55. IR2130J/IR2132J
T_J vs. Frequency (IRGPC20KD2)
R_{GATE} = 33Ω, V_{CC} = 15V

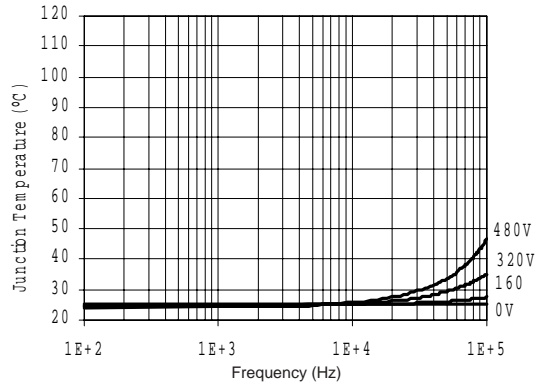

Figure 56. IR2130J/IR2132J
T_J vs. Frequency (IRGPC30KD2)
R_{GATE} = 20Ω, V_{CC} = 15V

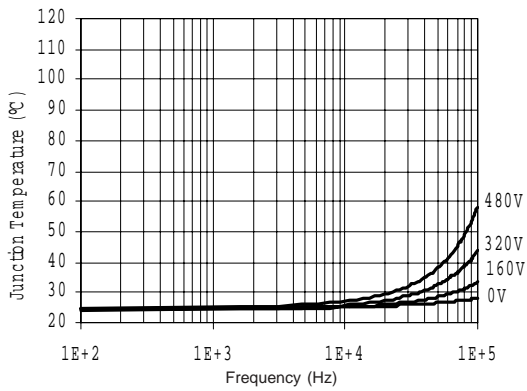

Figure 57. IR2130J/IR2132J
T_J vs. Frequency (IRGPC40KD2)
R_{GATE} = 15Ω, V_{CC} = 15V

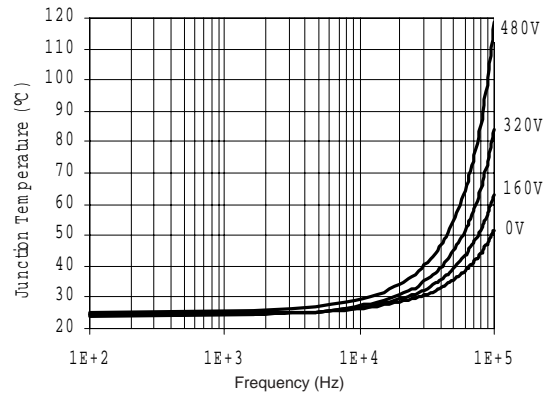
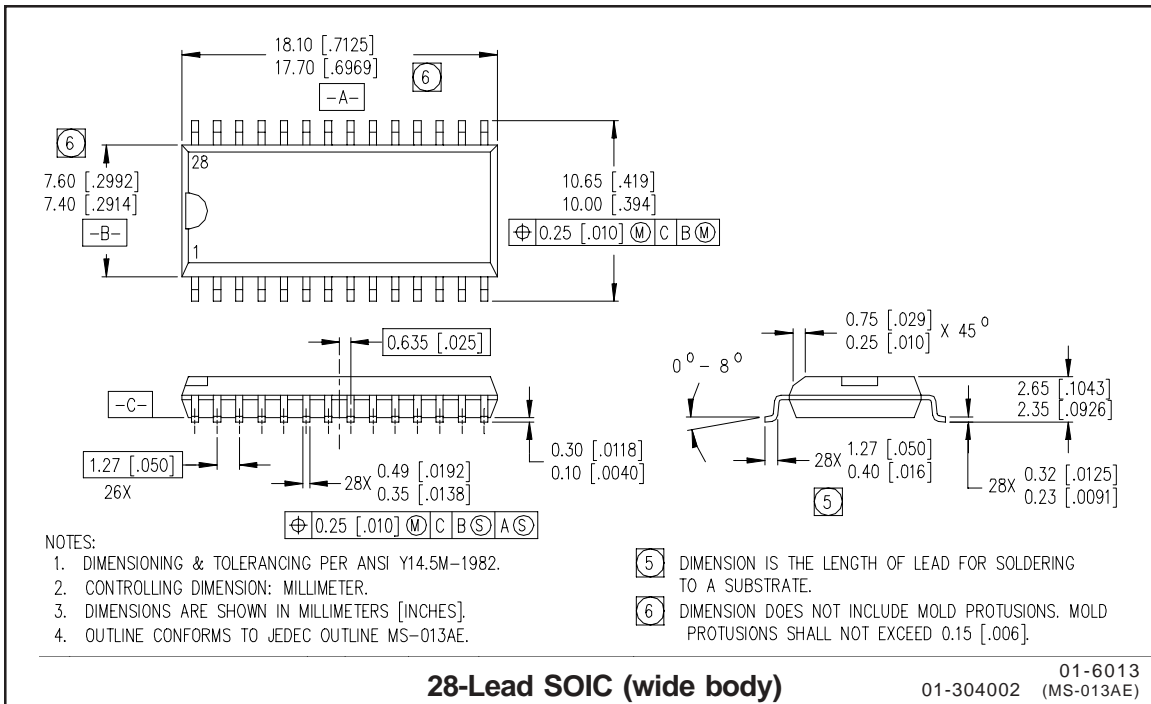

Figure 58. IR2130J/IR2132J
T_J vs. Frequency (IRGPC50KD2)
R_{GATE} = 10Ω, V_{CC} = 15V

IR2130/IR2132(J)(S) & (PbF)

International
IR Rectifier

Case outlines



IR2130/IR2132(J)(S) & (PbF)

Case outline



IR2130/IR2132(J)(S) & (PbF)

International
IR Rectifier

LEADFREE PART MARKING INFORMATION

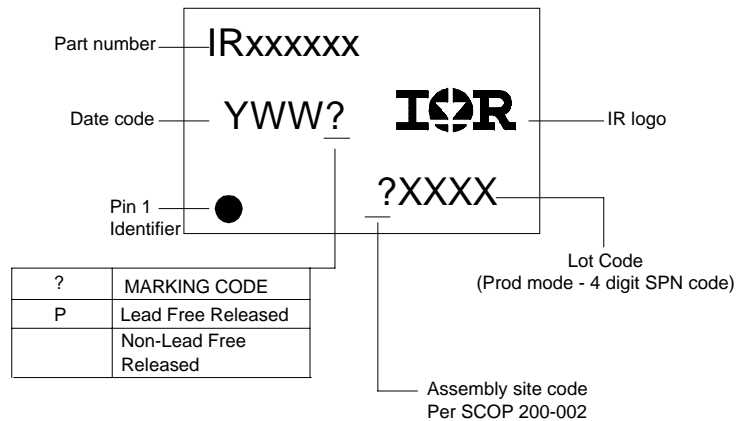

ORDER INFORMATION

Basic Part (Non-Lead Free)

28-Lead PDIP IR2130 order IR2130
 28-Lead SOIC IR2130S order IR2130S
 28-Lead PDIP IR2132 order IR2132
 28-Lead SOIC IR2132S order IR2132S
 44-Lead PLCC IR2130J order IR2130J
 44-Lead PLCC IR2132J order IR2132J

Leadfree Part

28-Lead PDIP IR2130 order IR2130PbF
 28-Lead SOIC IR2130S order IR2130SPbF
 28-Lead PDIP IR2132 order IR2132PbF
 28-Lead SOIC IR2132S order IR2132SPbF
 44-Lead PLCC IR2130J order IR2130JPbF
 44-Lead PLCC IR2132J order IR2132JPbF

International
IR Rectifier

IR WORLD HEADQUARTERS: 233 Kansas St., El Segundo, California 90245 Tel: (310) 252-7105

This product has been qualified per industrial level
 Data and specifications subject to change without notice. 4/2/2004