

NCP81063

Synchronous Buck MOSFET Drivers

The NCP81063 is a high-performance dual MOSFET gate driver in a small 3 mm x 3 mm package, optimized to drive the gates of both high-side and low-side power MOSFETs in a synchronous buck converter. A zero-current detection feature allows for a high-efficiency solution even at light load conditions. VCC UVLO ensures the MOSFETs are off when supply voltages are low. A bi-directional Enable pin provides a fault signal to the controller when a UVLO fault is detected.

Features

- Space-efficient 3 mm x 3 mm DFN8 Thermally-enhanced Package
- VCC Range of 4.5 V to 13.2 V
- Integrated Bootstrap Diode
- 5 V 3-stage PWM input
- Zero Current Detect Function Provides Power Saving Operation During Light Load Conditions
- Bi-directional Enable Feature Pulls Enable Pin Low During a UVLO Fault
- Output Disable Control Turns Off Both MOSFETs
- VCC Undervoltage Lockout
- Adaptive Anti-cross Conduction Circuit Protects Against Cross-conduction During FET Turn-on and Turn-off
- Direct Interface to NCP6151 and Other Compatible PWM Controllers
- Thermally Enhanced Package
- These Devices are Pb-Free, Halogen Free/BFR Free and are RoHS Compliant

Typical Applications

- Power Solutions for Notebook and Desktop Systems



ON Semiconductor®

www.onsemi.com



1
DFN8
MN SUFFIX
CASE 506BJ

MARKING DIAGRAM

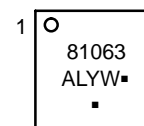

81063 = Specific Device Code
A = Assembly Location
L = Wafer Lot
Y = Year
W = Work Week
▪ = Pb-Free Package

(Note: Microdot may be in either location)

ORDERING INFORMATION

Device	Package	Shipping†
NCP81063MNTXG	DFN8 (Pb-Free)	3000/ Tape & Reel

†For information on tape and reel specifications, including part orientation and tape sizes, please refer to our Tape and Reel Packaging Specification Brochure, BRD8011/D.

NCP81063

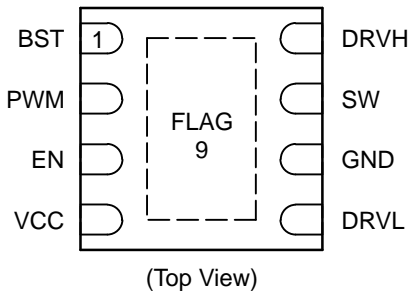

Figure 1. Pin Diagram



Figure 2. Block Diagram

Table 1. Pin Descriptions

Pin No.	Symbol	Description
1	BST	Floating bootstrap supply pin for high side gate driver. Connect the bootstrap capacitor between this pin and the SW pin.
2	PWM	Control input: PWM = High → DRVH is high, DRVL is low. PWM = Mid → Zero current detect enabled. Diode emulation mode. PWM = Low → DRVH is low, DRVL is high.
3	EN	3-state input: EN = High → Driver is enabled. EN = Low → Driver is disabled.
4	VCC	Power supply input. Connect a bypass capacitor (0.1 μF) from this pin to ground.
5	DRVL	Low side gate drive output. Connect to the gate of low side MOSFET.
6	GND	Bias and reference ground. All signals are referenced to this node (QFN Flag).
7	SW	Switch node. Connect this pin to the source of the high side MOSFET and drain of the low side MOSFET.
8	DRVH	High side gate drive output. Connect to the gate of high side MOSFET.
9	FLAG	Thermal flag. There is no electrical connection to the IC. Connect to ground plane.

NCP81063

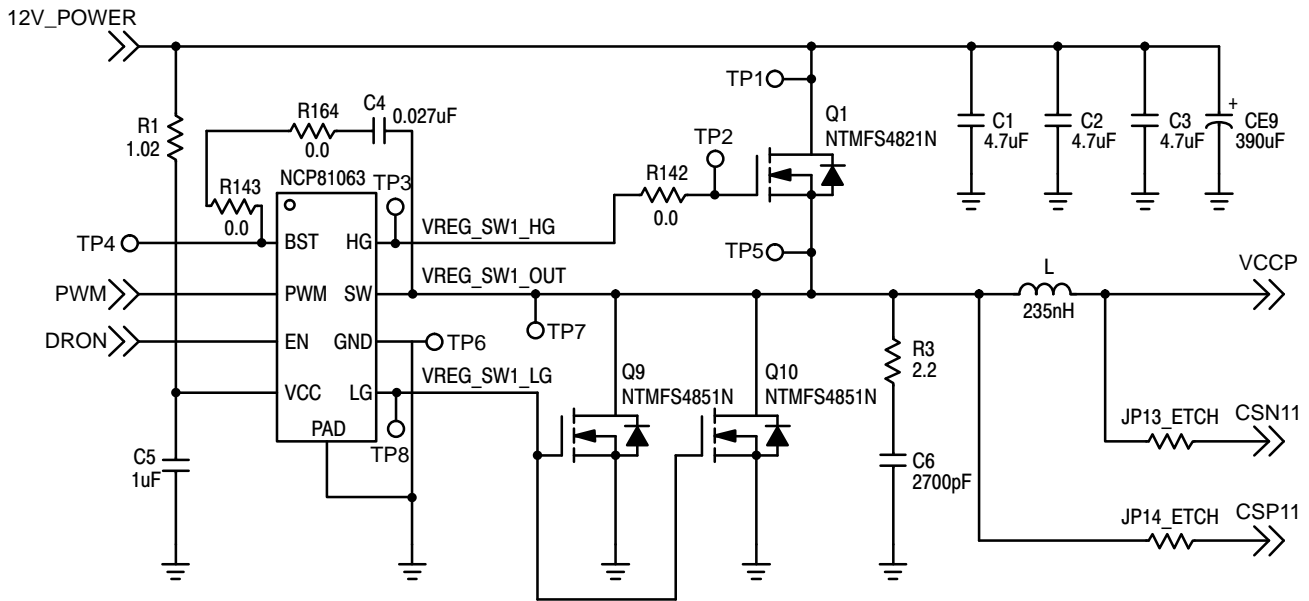

Figure 3. Application Circuit

Table 2. ABSOLUTE MAXIMUM RATINGS

Pin Symbol	Pin Name	V _{MAX}	V _{MIN}
VCC	Main Supply Voltage Input	15 V 16 V (< 50 ns)	-0.3 V
BST	Bootstrap Supply Voltage	35 V wrt/ GND 40 V ≤ 50 ns wrt/ GND 15 V wrt/ SW	-0.3 V wrt/SW
SW	Switching Node (Bootstrap Supply Return)	35 V 40 V ≤ 50 ns	-5 V -10 V (200 ns)
DRVH	High Side Driver Output	BST+0.3 V SW + 15 V (< 80 ns)	-0.3 V wrt/SW -2 V (<200 ns) wrt/SW
DRVL	Low Side Driver Output	VCC+0.3 V 15 V (< 80 ns)	-0.3 V DC -5 V (<200 ns)
PWM	DRVH and DRVL Control Input	6.5 V	-0.3 V
EN	Enable Pin	6.5 V	-0.3 V
GND	Ground	0 V	0 V

Stresses exceeding those listed in the Maximum Ratings table may damage the device. If any of these limits are exceeded, device functionality should not be assumed, damage may occur and reliability may be affected.

Table 3. THERMAL INFORMATION (All signals referenced to AGND unless noted otherwise)

Symbol	Parameter	Value	Unit
R _{θJA}	Thermal Characteristic (Note 1)	74	°C/W
T _J	Operating Junction Temperature Range	-40 to 125	°C
T _A	Operating Ambient Temperature Range	-10 to +125	°C
T _{STG}	Maximum Storage Temperature Range	-55 to +150	°C
MSL	Moisture Sensitivity Level	1	

* The maximum package power dissipation must be observed.
1. 1 in² Cu, 1 oz thickness.

NCP81063

Table 4. ELECTRICAL CHARACTERISTICS (Unless otherwise stated: $-10^{\circ}\text{C} < T_A < +125^{\circ}\text{C}$; $4.5\text{ V} < V_{\text{CC}} < 13.2\text{ V}$, $4.5\text{ V} < \text{BST-SWN} < 13.2\text{ V}$, $4.5\text{ V} < \text{BST} < 30\text{ V}$, $0\text{ V} < \text{SWN} < 21\text{ V}$)

Parameter	Test Conditions	Min.	Typ.	Max.	Units
SUPPLY VOLTAGE					
VCC Operation Voltage		4.5		13.2	V
UNDERVOLTAGE LOCKOUT					
VCC Start Threshold		3.8	4.35	4.5	V
VCC UVLO Hysteresis		150	200	250	mV
SUPPLY CURRENT					
Normal Mode	$I_{\text{CC}} + I_{\text{BST}}$, EN = 5 V, PWM = OSC, Fsw = 100 KHz, Cload = 3 nF for DRVH, 3 nF for DRVL		10		mA
Standby Current	$I_{\text{CC}} + I_{\text{BST}}$, EN = GND		0.5	1.4	mA
Standby Current	$I_{\text{CC}} + I_{\text{BST}}$, EN = HIGH, PWM = LOW, No loading on DRVH & DRVL		2.0		mA
Standby Current	$I_{\text{CC}} + I_{\text{BST}}$, EN = HIGH, PWM = HIGH, No loading on DRVH & DRVL		2.0		mA
BOOTSTRAP DIODE					
Forward Voltage	$V_{\text{CC}} = 12\text{ V}$, forward bias current = 2 mA	0.1	0.4	0.6	V
PWM INPUT					
PWM Input High		3.4			V
PWM Mid-State		1.3		2.7	V
PWM Input Low				0.7	V
ZCD Blanking Timer			250		ns
HIGH SIDE DRIVER (VCC = 12 V)					
Output Impedance, Sourcing Current	VBST – VSW = 12 V		1.9	3.0	Ω
Output Impedance, Sinking Current	VBST – VSW = 12 V		1.0	1.7	Ω
DRVH Rise Time t_{rDRVH}	$V_{\text{VCC}} = 12\text{ V}$, 3 nF load, VBST–VSW = 12 V		16	30	ns
DRVH Fall Time t_{fDRVH}	$V_{\text{VCC}} = 12\text{ V}$, 3 nF load, VBST–VSW = 12 V		11	25	ns
DRVH Turn–Off Propagation Delay t_{pdDRVH}	$C_{\text{LOAD}} = 3\text{ nF}$	8.0		30	ns
DRVH Turn–On Propagation Delay t_{pdhDRVH}	$C_{\text{LOAD}} = 3\text{ nF}$			30	ns
SW Pull Down Resistance	SW to PGND		37.5		k Ω
DRVH Pull Down Resistance	DRVH to SW, BST–SW = 0 V		37.55		k Ω
HIGH SIDE DRIVER (VCC = 5 V)					
Output Impedance, Sourcing Current	VBST – VSW = 5 V		2.5		Ω
Output Impedance, Sinking Current	VBST – VSW = 5 V		1.6		Ω
DRVH Rise Time t_{rDRVH}	$V_{\text{VCC}} = 5\text{ V}$, 3 nF load, VBST – VSW = 5 V		30		ns
DRVH Fall Time t_{fDRVH}	$V_{\text{VCC}} = 5\text{ V}$, 3 nF load, VBST – VSW = 5 V		27		ns
DRVH Turn–Off Propagation Delay t_{pdDRVH}	$C_{\text{LOAD}} = 3\text{ nF}$		20		ns
DRVH Turn–On Propagation Delay t_{pdhDRVH}	$C_{\text{LOAD}} = 3\text{ nF}$		27		ns
SW Pull Down Resistance	SW to PGND		37.5		k Ω
DRVH Pull Down Resistance	DRVH to SW, BST–SW = 0 V		37.5		k Ω
LOW SIDE DRIVER (VCC = 12 V)					
Output Impedance, Sourcing Current			2.0	3.0	Ω

NCP81063

Table 4. ELECTRICAL CHARACTERISTICS (Unless otherwise stated: $-10^{\circ}\text{C} < T_A < +125^{\circ}\text{C}$; $4.5\text{ V} < V_{CC} < 13.2\text{ V}$, $4.5\text{ V} < \text{BST-SWN} < 13.2\text{ V}$, $4.5\text{ V} < \text{BST} < 30\text{ V}$, $0\text{ V} < \text{SWN} < 21\text{ V}$)

Parameter	Test Conditions	Min.	Typ.	Max.	Units
LOW SIDE DRIVER (VCC = 12 V)					
Output Impedance, Sinking Current			0.7	1.5	Ω
DRV L Rise Time $t_{r\text{DRV L}}$	$C_{\text{LOAD}} = 3\text{ nF}$		16	35	ns
DRV L Fall Time $t_{f\text{DRV L}}$	$C_{\text{LOAD}} = 3\text{ nF}$		11	20	ns
DRV L Turn-Off Propagation Delay $t_{pd\text{DRV L}}$	$C_{\text{LOAD}} = 3\text{ nF}$			35	ns
DRV L Turn-On Propagation Delay $t_{pdh\text{DRV L}}$	$C_{\text{LOAD}} = 3\text{ nF}$	8.0		30	ns
DRV L Pull Down Resistance	DRV L to PGND, VCC = PGND		37.5		$\text{k}\Omega$
LOW SIDE DRIVER (VCC = 5 V)					
Output Impedance, Sourcing Current			2.5		Ω
Output Impedance, Sinking Current			1.0		Ω
DRV L Rise Time $t_{r\text{DRV L}}$	$C_{\text{LOAD}} = 3\text{ nF}$		30		ns
DRV L Fall Time $t_{f\text{DRV L}}$	$C_{\text{LOAD}} = 3\text{ nF}$		22		ns
DRV L Turn-Off Propagation Delay $t_{pd\text{DRV L}}$	$C_{\text{LOAD}} = 3\text{ nF}$		27		ns
DRV L Turn-On Propagation Delay $t_{pdh\text{DRV L}}$	$C_{\text{LOAD}} = 3\text{ nF}$		12		ns
DRV L Pull Down Resistance	DRV L to PGND, VCC = PGND		37.5		$\text{k}\Omega$
EN INPUT					
Input Voltage High		2.0			V
Input Voltage Low				1.0	V
Hysteresis			500		mV
Normal Mode Bias Current		-1		1	μA
Enable Pin Sink Current		4		30	mA
Propagation Delay Time			20	40	ns
SW Node					
SW Node Leakage Current				20	μA
Zero Cross Detection Threshold Voltage	SW to -20 mV , ramp slowly until BG goes off (Start in DCM mode) (Note 2)		-3		mV

Table 5. DECODER TRUTH TABLE

PWM INPUT	ZCD	DRV L	DRV H
PWM High	ZCD Reset	Low	High
PWM Mid	Positive current through the inductor	High	Low
PWM Mid	Zero current through the inductor	Low	Low
PWM Low	ZCD Reset	High	Low

2. Guaranteed by design; not production tested.

NCP81063



Figure 4.

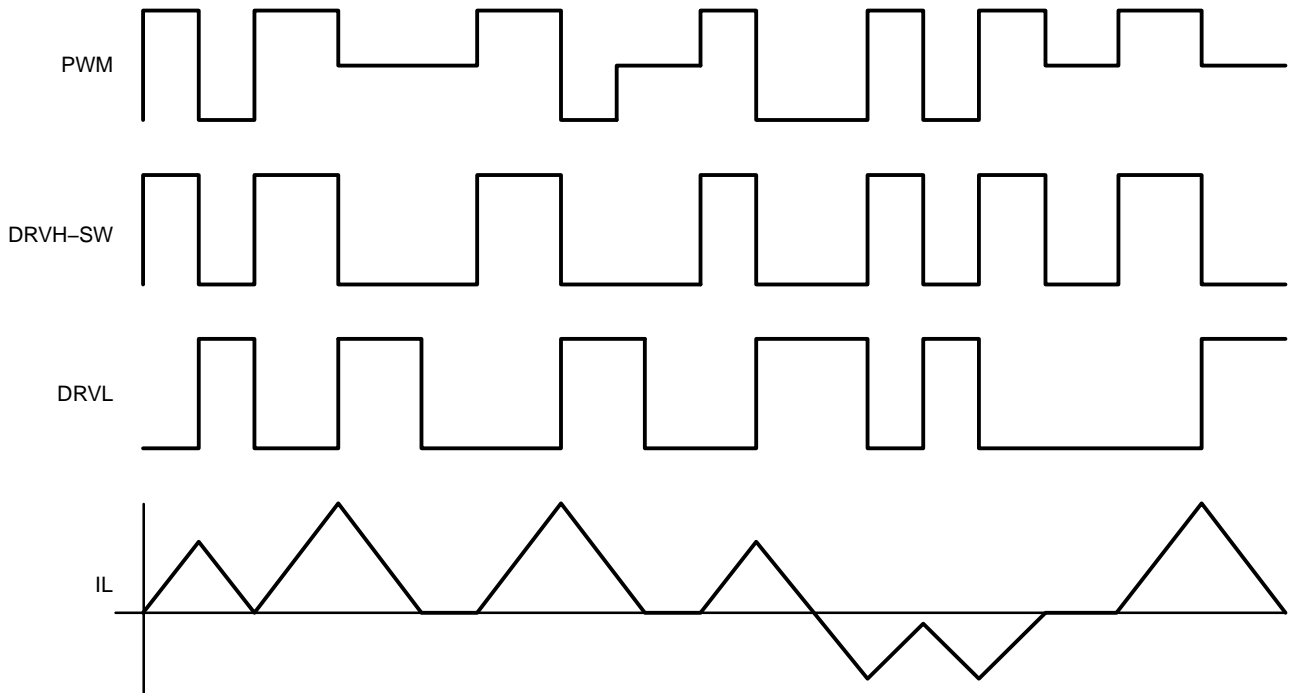

Figure 5. Timing Diagram

APPLICATIONS INFORMATION

The NCP81063 gate driver is a single-phase MOSFET driver designed for driving N-channel MOSFETs in a synchronous buck converter topology.

Low-Side Driver

The low-side driver is designed to drive a ground-referenced low- $R_{DS(on)}$ N-channel MOSFET. The voltage supply for the low-side driver is internally connected to the VCC and GND pins.

High-Side Driver

The high-side driver is designed to drive a floating low- $R_{DS(on)}$ N-channel MOSFET. The gate voltage for the high-side driver is developed by a bootstrap circuit referenced to the SW pin.

The bootstrap circuit is comprised of the integrated diode and an external bootstrap capacitor. When the NCP81063 is starting up, the SW pin is held at ground, allowing the bootstrap capacitor to charge up to VCC through the bootstrap diode. When the PWM input is driven high, the high-side driver will turn on the high-side MOSFET using the stored charge of the bootstrap capacitor. As the high-side MOSFET turns on, the SW pin rises. When the high-side MOSFET is fully turned on, SW will settle to VIN and BST will settle to VIN + VCC (excluding parasitic ringing).

Bootstrap Circuit

The bootstrap circuit relies on an external charge storage capacitor (C_{BST}) and an integrated diode to provide current to the high-side driver. A multi-layer ceramic capacitor (MLCC) with a value greater than 100 nF should be used for C_{BST} .

Power Supply Decoupling

The NCP81063 can source and sink relatively large currents to the gate pins of the MOSFETs. In order to maintain a constant and stable supply voltage, a low-ESR capacitor should be placed near the VCC and GND pins. A MLCC between 1 μ F and 4.7 μ F is typically used.

Undervoltage Lockout

DRVH and DRVL are low until VCC reaches the VCC UVLO threshold, typically 4.35 V. Once VCC reaches this threshold, the PWM signal will control DRVH and DRVL. There is a 200 mV hysteresis on VCC UVLO. There are pull-down resistors on DRVH, DRVL and SW to prevent the gates of the MOSFETs from accumulating enough charge to turn on when the driver is powered off.

Bi-Directional EN Signal

The Enable pin (EN) is used to disable the DRVH and DRVL outputs to prevent power transfer. When EN is above the EN_{HI} threshold, DRVH and DRVL change their states according to the PWM input. A UVLO fault turns on the internal MOSFET that pulls the EN pin towards ground. By connecting EN to the DRON pin of a controller, the

controller is alerted when the driver encounters a fault condition.

Three-State PWM Input

Switching PWM between logic-high and logic-low states will allow the driver to operate in continuous conduction mode as long as VCC is greater than the UVLO threshold and EN is high. The threshold limits are specified in the electrical characteristics table in this datasheet. Refer to Figure 21 for the gate timing diagrams and Table 1 for the EN/PWM logic table.

When PWM is set above PWM_{HI} , DRVL will first turn off after a propagation delay of tpd_{DRVL} . To ensure non-overlap between DRVL and DRVH, there is a delay of $tpdh_{DRVH}$ from the time DRVL falls to 1 V, before DRVH is allowed to turn on.

When PWM falls below PWM_{LO} , DRVH will first turn off after a propagation delay of tpd_{DRVH} . To ensure non-overlap between DRVH and DRVL, there is a delay of $tpdh_{DRVL}$ from the time DRVH – SW falls to 1 V, before DRVL is allowed to turn on.

When PWM enters the mid-state voltage range, PWM_{MID} , DRVL goes high after the non-overlap delay, and stays high for the duration of the ZCD blanking timer and an 80 ns de-bounce timer. Once these timers expire, SW is monitored for zero current detection and pulls DRVL low once zero current is detected.

Thermal Considerations

As power in the NCP81063 increases, it might become necessary to provide some thermal relief. The maximum power dissipation supported by the device is dependent upon board design and layout. Mounting pad configuration on the PCB, the board material, and the ambient temperature affect the rate of junction temperature rise for the part. When the NCP81063 has good thermal conductivity through the PCB, the junction temperature will be relatively low with high power applications. The maximum dissipation the NCP81063 can handle is given by:

$$P_{D(MAX)} = \frac{[T_{J(MAX)} - T_A]}{R_{\theta JA}} \quad (\text{eq. 1})$$

Since T_J is not recommended to exceed 150°C, the NCP81063, soldered on to a 645 mm² copper area, using 1 oz. copper and FR4, can dissipate up to 2.3 W when the ambient temperature (T_A) is 25°C. The power dissipated by the NCP81063 can be calculated from the following equation:

$$P_D = VCC \times \left[(n_{HS} \times Q_{gHS} + n_{LS} \times Q_{gLS}) \times f + I_{standby} \right] \quad (\text{eq. 2})$$

Where n_{HS} and n_{LS} are the number of high-side and low-side FETs, respectively, Q_{gHS} and Q_{gLS} are the gate charges of the high-side and low-side FETs, respectively and f is the switching frequency of the converter.

MECHANICAL CASE OUTLINE

PACKAGE DIMENSIONS

ON Semiconductor®



SCALE 2:1

DFN8 3x3, 0.5P
CASE 506BJ-01
ISSUE O

DATE 08 NOV 2007

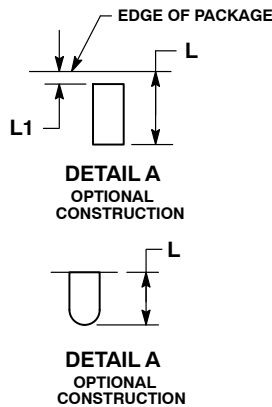

NOTES:

1. DIMENSIONS AND TOLERANCING PER ASME Y14.5M, 1994.
2. CONTROLLING DIMENSION: MILLIMETERS.
3. DIMENSION b APPLIES TO PLATED TERMINAL AND IS MEASURED BETWEEN 0.15 AND 0.30 MM FROM TERMINAL.
4. COPLANARITY APPLIES TO THE EXPOSED PAD AS WELL AS THE TERMINALS.

MILLIMETERS		
DIM	MIN	MAX
A	0.80	1.00
A1	0.00	0.05
A3	0.20	REF
b	0.18	0.30
D	3.00	BSC
D2	1.64	1.84
E	3.00	BSC
E2	1.35	1.55
e	0.50	BSC
K	0.20	---
L	0.30	0.50
L1	0.00	0.03

GENERIC MARKING DIAGRAM*

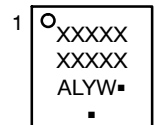

- XXXXX = Specific Device Code
- A = Assembly Location
- L = Wafer Lot
- Y = Year
- W = Work Week
- = Pb-Free Package

(Note: Microdot may be in either location)
*This information is generic. Please refer to device data sheet for actual part marking.
Pb-Free indicator, "G" or microdot "▪", may or may not be present.

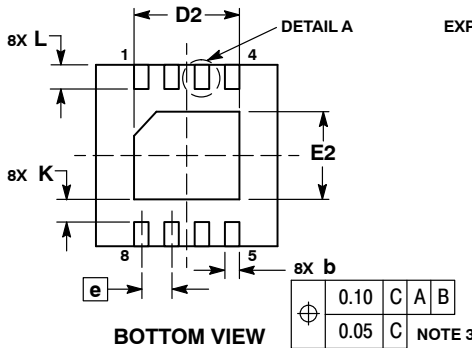

SOLDEMASK DEFINED MOUNTING FOOTPRINT

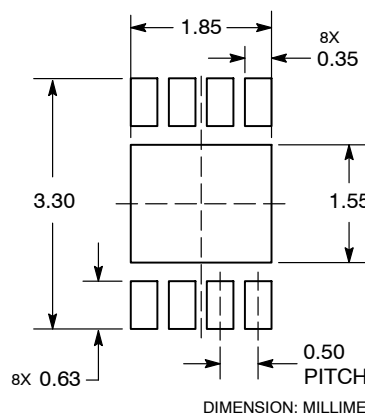

*For additional information on our Pb-Free strategy and soldering details, please download the ON Semiconductor Soldering and Mounting Techniques Reference Manual, SOLDERRM/D.

DOCUMENT NUMBER:	98AON25786D	Electronic versions are uncontrolled except when accessed directly from the Document Repository. Printed versions are uncontrolled except when stamped "CONTROLLED COPY" in red.
DESCRIPTION:	DFN8 3X3, 0.5P	PAGE 1 OF 1

ON Semiconductor and ON are trademarks of Semiconductor Components Industries, LLC dba ON Semiconductor or its subsidiaries in the United States and/or other countries. ON Semiconductor reserves the right to make changes without further notice to any products herein. ON Semiconductor makes no warranty, representation or guarantee regarding the suitability of its products for any particular purpose, nor does ON Semiconductor assume any liability arising out of the application or use of any product or circuit, and specifically disclaims any and all liability, including without limitation special, consequential or incidental damages. ON Semiconductor does not convey any license under its patent rights nor the rights of others.

onsemi, **Onsemi**, and other names, marks, and brands are registered and/or common law trademarks of Semiconductor Components Industries, LLC dba "**onsemi**" or its affiliates and/or subsidiaries in the United States and/or other countries. **onsemi** owns the rights to a number of patents, trademarks, copyrights, trade secrets, and other intellectual property. A listing of **onsemi**'s product/patent coverage may be accessed at www.onsemi.com/site/pdf/Patent-Marking.pdf. **onsemi** reserves the right to make changes at any time to any products or information herein, without notice. The information herein is provided "as-is" and **onsemi** makes no warranty, representation or guarantee regarding the accuracy of the information, product features, availability, functionality, or suitability of its products for any particular purpose, nor does **onsemi** assume any liability arising out of the application or use of any product or circuit, and specifically disclaims any and all liability, including without limitation special, consequential or incidental damages. Buyer is responsible for its products and applications using **onsemi** products, including compliance with all laws, regulations and safety requirements or standards, regardless of any support or applications information provided by **onsemi**. "Typical" parameters which may be provided in **onsemi** data sheets and/or specifications can and do vary in different applications and actual performance may vary over time. All operating parameters, including "Typicals" must be validated for each customer application by customer's technical experts. **onsemi** does not convey any license under any of its intellectual property rights nor the rights of others. **onsemi** products are not designed, intended, or authorized for use as a critical component in life support systems or any FDA Class 3 medical devices or medical devices with a same or similar classification in a foreign jurisdiction or any devices intended for implantation in the human body. Should Buyer purchase or use **onsemi** products for any such unintended or unauthorized application, Buyer shall indemnify and hold **onsemi** and its officers, employees, subsidiaries, affiliates, and distributors harmless against all claims, costs, damages, and expenses, and reasonable attorney fees arising out of, directly or indirectly, any claim of personal injury or death associated with such unintended or unauthorized use, even if such claim alleges that **onsemi** was negligent regarding the design or manufacture of the part. **onsemi** is an Equal Opportunity/Affirmative Action Employer. This literature is subject to all applicable copyright laws and is not for resale in any manner.

PUBLICATION ORDERING INFORMATION

LITERATURE FULFILLMENT:

Email Requests to: orderlit@onsemi.com

onsemi Website: www.onsemi.com

TECHNICAL SUPPORT

North American Technical Support:

Voice Mail: 1 800-282-9855 Toll Free USA/Canada

Phone: 011 421 33 790 2910

Europe, Middle East and Africa Technical Support:

Phone: 00421 33 790 2910

For additional information, please contact your local Sales Representative