



High-Speed, 6A Single MOSFET Drivers

General Description

The MAX4420, MAX4429 and MXT429 are single-output MOSFET drivers designed to translate TTL/CMOS inputs to high-voltage/high-current outputs. The low 1.5Ω output impedance and 6A peak current output allow them to rapidly switch high-capacitance power MOSFETs, improving efficiency.

A 40ns delay time and a 25ns rise or fall time (while driving 2500pF to 18V) minimize power losses during MOSFET switching transitions.

The MAX4420/MAX4429/MXT429 interface easily with either CMOS or bipolar switch-mode controllers because their logic inputs draw under 10μA. The outputs swing to within 25mV of GND or the power-supply rail, which can be 4.5V to 18V for the MAX4420/MAX4429, and 7V to 18V for the MXT429.

Power-supply quiescent current is typically 45μA and 450μA for logic input low and high, respectively. The MAX4420 has a non inverting output. The MAX4429 and MXT429 have inverting outputs.

For dual drivers, refer to the MAX626/MAX627/MAX628 and MAX4426/MAX4427/MAX4428 data sheets.

Applications

- Switching Power Supplies
- DC-DC Converters
- Motor Controllers
- Pin-Diode Drivers

Pin Configurations

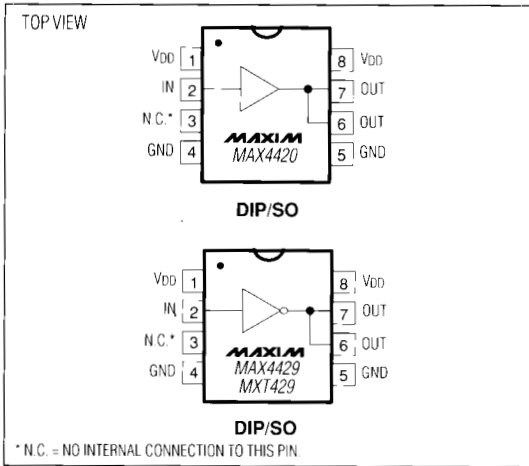

Features

- ◆ TTL/CMOS Compatible ($I_{IN} \leq 10\mu A$)
- ◆ 4.5V to 18V Supply Range (MAX4420/MAX4429)
- ◆ 1.5Ω Output Resistance
- ◆ 6A Peak Output Current
- ◆ 40ns Delay Time
- ◆ 25ns Rise and Fall Times (2500pF Load)
- ◆ Output Swings to within 25mV of V_{DD} and GND

Ordering Information

PART	TEMP. RANGE	PIN-PACKAGE
MAX4420CPA	0°C to +70°C	8 Plastic DIP
MAX4420CSA	0°C to +70°C	8 SO
MAX4420C/D	0°C to +70°C	Dice*
MAX4420EPA	-40°C to +85°C	8 Plastic DIP
MAX4420ESA	-40°C to +85°C	8 SO
MAX4420MJA	-55°C to +125°C	8 CERDIP**
MAX4429CPA	0°C to +70°C	8 Plastic DIP
MAX4429CSA	0°C to +70°C	8 SO
MAX4429C/D	0°C to +70°C	Dice*
MAX4429EPA	-40°C to +85°C	8 Plastic DIP
MAX4429ESA	-40°C to +85°C	8 SO
MAX4429MJA	-55°C to +125°C	8 CERDIP**

Ordering information continued on last page.

* Dice are specified at $T_A = +25^\circ C$.

** Contact factory for availability and processing to MIL-STD-883 and DESC-SMD.

Typical Operating Circuit

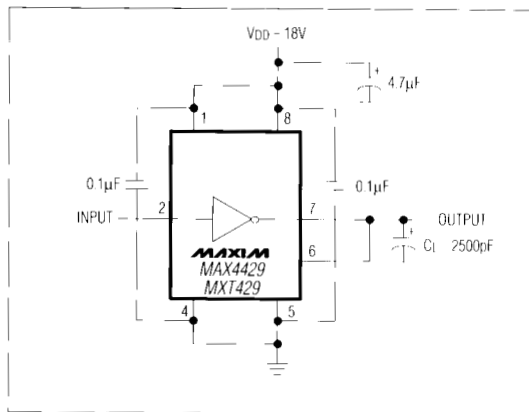

MAX4420/MAX4429/MXT429

High-Speed, 6A Single MOSFET Drivers

ABSOLUTE MAXIMUM RATINGS

Supply Voltage V_{DD} to GND	+20V	Operating Temperature Ranges:	
Input Voltage V_{IN}	-0.3V to (V_{DD} + 0.3V)	MAX442_C__, MXT429C__	0°C to +70°C
Continuous Power Dissipation ($T_A = +70^\circ\text{C}$)		MAX442_E__, MXT429E__	-40°C to +85°C
Plastic DIP (derate 9.09mW/°C above +70°C)	727mW	MAX442_MJA, MXT429MJA	-55°C to +125°C
SO (derate 5.88mW/°C above +70°C)	471mW	Storage Temperature Range	-65°C to +160°C
CERDIP (derate 8.00mW/°C above +70°C)	640mW	Lead Temperature (soldering, 10sec)	+300°C

Stresses beyond those listed under "Absolute Maximum Ratings" may cause permanent damage to the device. These are stress ratings only, and functional operation of the device at these or any other conditions beyond those indicated in the operational sections of the specifications is not implied. Exposure to absolute maximum rating conditions for extended periods may affect device reliability.

ELECTRICAL CHARACTERISTICS

(MAX4420/MAX4429 $V_{DD} = +4.5\text{V}$ to +18V, MXT429 $V_{DD} = +7\text{V}$ to +18V, $T_A = T_{MIN}$ to T_{MAX} , unless otherwise noted.)

PARAMETER	SYMBOL	CONDITIONS	MAX4420/MAX4429			MXT429			UNITS	
			MIN	TYP	MAX	MIN	TYP	MAX		
Operating Range	V_{DD}		4.5		18	7		18	V	
Power Supply Current	I_{DD}	$V_{IN} = 3\text{V}$	$T_A = +25^\circ\text{C}$	0.45	1.5	0.45	5.0			mA
			$T_A = T_{MIN}$ to T_{MAX}		3.0		12.0			
		$V_{IN} = 0\text{V}$	$T_A = +25^\circ\text{C}$	0.045	0.150	0.045	0.5			
			$T_A = T_{MIN}$ to T_{MAX}		0.400		1.0			
Logic 1 Input Voltage	V_{IH}		2.4			2.4			V	
Logic 0 Input Voltage	V_{IL}				0.8			0.8	V	
IN Leakage Current	I_{IN}	$V_{IN} = 0\text{V}$ to V_{DD}			± 10			± 10	μA	
Output High Voltage	V_{OH}	No load			$V_{DD} - 25$			$V_{DD} - 25$	mV	
Output Low Voltage	V_{OL}	No load			25			25	mV	
Peak Output Current	I_{OUT}	$V_{DD} = 18\text{V}$			6			6	A	
Output Resistance	R_{OUT}	$V_{DD} = 18\text{V}$, $I_{OUT} = 10\text{mA}$, $V_{IN} = 0.8\text{V}$ or 2.4V	$T_A = +25^\circ\text{C}$	1.5	2.5	1.5	2.5			Ω
			$T_A = T_{MIN}$ to T_{MAX}		5.0		5.0			
Rise Time (Note 1)	t_R	Figure 1	$T_A = +25^\circ\text{C}$	25	30	25	35			ns
			$T_A = T_{MIN}$ to T_{MAX}		60		70			
Fall Time (Note 1)	t_F	Figure 1	$T_A = +25^\circ\text{C}$	25	30	25	35			ns
			$T_A = T_{MIN}$ to T_{MAX}		60		70			
Delay Time (Note 1)	t_{D1}	Figure 1	$T_A = +25^\circ\text{C}$	35	60	35	75			ns
			$T_A = T_{MIN}$ to T_{MAX}		100		100			
	t_{D2}	Figure 1	$T_A = +25^\circ\text{C}$	40	60	40	75			
			$T_A = T_{MIN}$ to T_{MAX}		100		120			

Note 1: Switching times guaranteed by design, not tested. See Figure 1 for timing measurement circuit, $V_{DD} = 18\text{V}$.

High-Speed, 6A Single MOSFET Drivers

Typical Operating Characteristics

MAX4420/MAX4429/MXT429

MAX4429 SWITCHING SPEED (INPUT HIGH TO LOW)

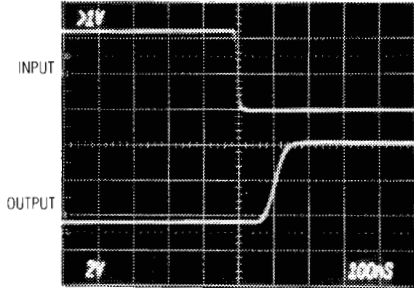

$V_{DD} = 4.5V$, $C_L = 2500pF$, TIME = 100ns/div,
 $V_{IN} = 5V$ TO $0V$,
 $T_A = +25^\circ C$

MAX4429 SWITCHING SPEED (INPUT LOW TO HIGH)

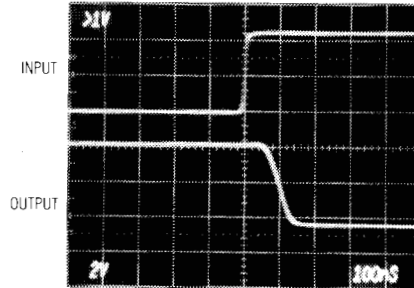

$V_{DD} = 4.5V$, $C_L = 2500pF$, TIME = 100ns/div,
 $V_{IN} = 0V$ TO $5V$,
 $T_A = +25^\circ C$

MAX4429 SWITCHING SPEED (INPUT HIGH TO LOW)



$V_{DD} = 18V$, $C_L = 2500pF$, TIME = 100ns/div,
 $V_{IN} = 5V$ TO $0V$,
 $T_A = +25^\circ C$

MAX4429 SWITCHING SPEED (INPUT LOW TO HIGH)

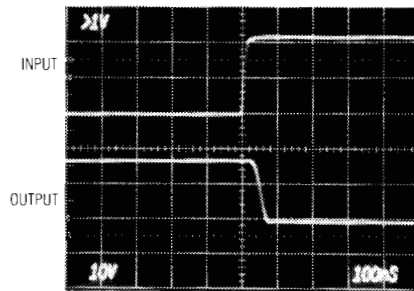

$V_{DD} = 18V$, $C_L = 2500pF$, TIME = 100ns/div,
 $V_{IN} = 0V$ TO $5V$,
 $T_A = +25^\circ C$

FALL TIME vs. POSITIVE SUPPLY VOLTAGE



RISE TIME vs. POSITIVE SUPPLY VOLTAGE

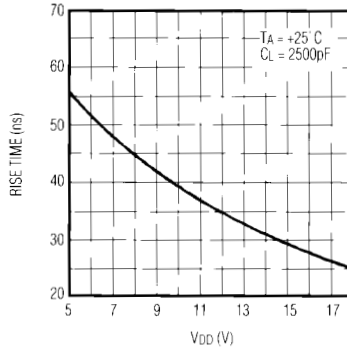

RISE AND FALL TIMES vs. TEMPERATURE

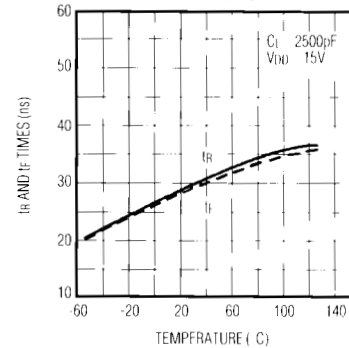

High-Speed, 6A Single MOSFET Drivers

Typical Operating Characteristics (continued)

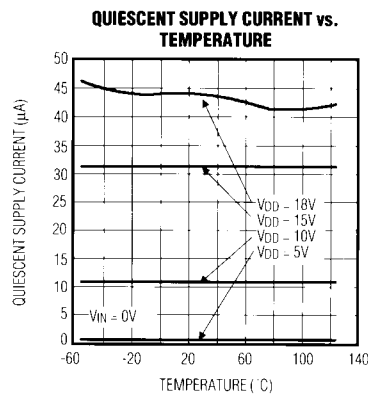
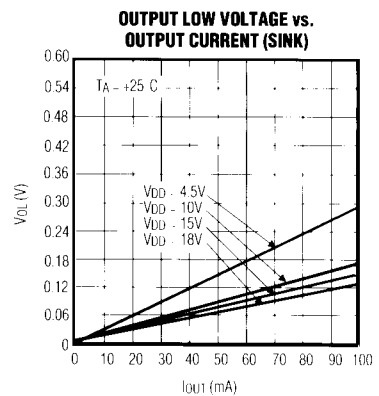
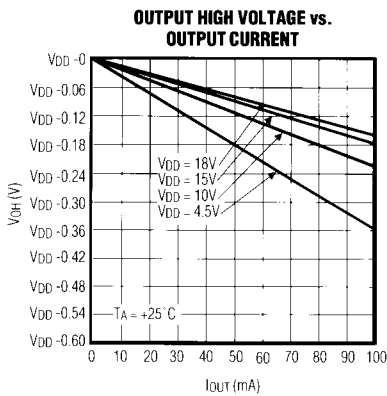
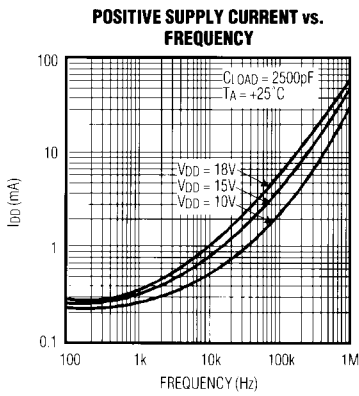
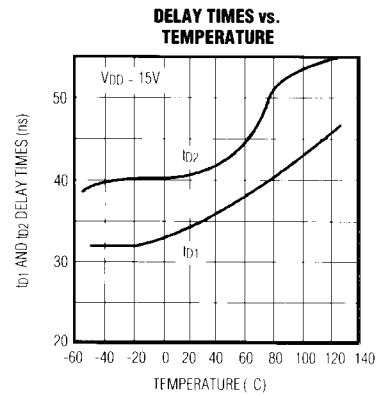
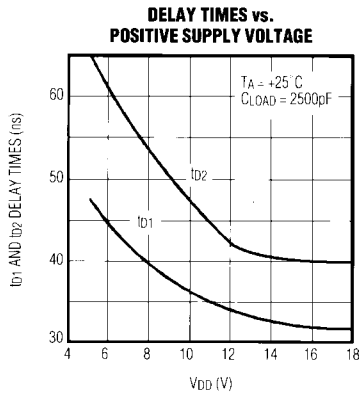
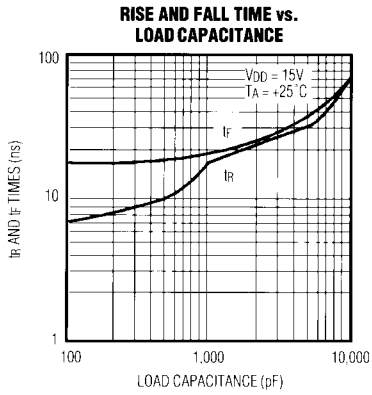

High-Speed, 6A Single MOSFET Drivers

MAX4420/MAX4429/MXT429

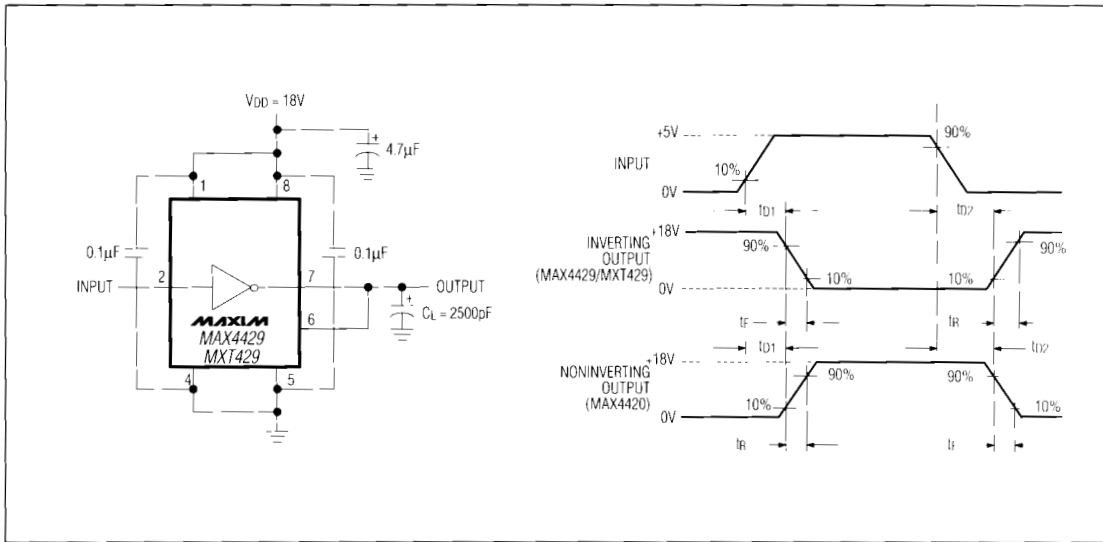

Figure 1. Switching-Time Measurement Circuit

Applications Information

The MAX4420/MAX4429/MXT429 have easy-to-drive inputs. However, the input must not be allowed to stay between V_{IH} and V_{IL} for more than 500ns. The power supply (V_{DD}) inputs must always be tied together, as should the outputs (OUT).

Supply bypassing and grounding are extremely important, as the peak supply and output currents can be greater than 6A. Ground drops are a form of negative feedback with inverters, and therefore will degrade the delay and transition time. Ringing may also be a problem with large $\Delta V/\Delta t$ and/or large AC currents.

Suggested bypass capacitors are a 4.7µF (low ESR) capacitor in parallel with 0.1µF ceramic capacitors, mounted as close as possible to the device. Use a ground plane if possible, or separate ground returns for inputs and outputs. Ringing can be minimized with a 5Ω resistor in series with the output, but this will degrade output transition time.

Power Dissipation

Power dissipation of the MAX4420/MAX4429/MXT429 consists of:

- 1) input inverter losses
- 2) crowbar current through the output devices
- 3) output current (either capacitive or resistive).

The sum of these must be kept below the maximum power-dissipation limit.

The DC input inverter losses are typically 45µA when the input is low and 450µA when the input is high.

The crowbar current through an output device making a transition is approximately 100mA for a few nanoseconds. This is a small portion of the total supply current, except for high switching frequencies or a small load capacitance (100pF).

The MAX4420/MAX4429/MXT429 power dissipation when driving a ground referenced resistive load is:

$$P = D \times R_{ON(max)} \times I_{LOAD}^2$$

where D is the percentage of time the MAX4420/MAX4429/MXT429 output pulls high, $R_{ON(max)}$ is the maximum on resistance of the device with the output high, and I_{LOAD} is the load current of the MAX4420/MAX4429/MXT429.

For capacitive loads, the power dissipation is:

$$P = C_{LOAD} \times V_{DD}^2 \times FREQ$$

where C_{LOAD} is the capacitive load, V_{DD} is the MAX4420/MAX4429/MXT429 supply voltage, and $FREQ$ is the toggle frequency.

High-Speed, 6A Single MOSFET Drivers

Ordering Information (continued)

PART	TEMP. RANGE	PIN-PACKAGE
MXT429CPA	0°C to +70°C	8 Plastic DIP
MXT429CSA	0°C to +70°C	8 SO
MXT429C/D	0°C to +70°C	Dice*
MXT429EPA	-40°C to +85°C	8 Plastic DIP
MXT429ESA	-40°C to +85°C	8 SO
MXT429MJA	-55°C to +125°C	8 CERDIP**

* Dice are specified at $T_A = +25^\circ\text{C}$.

** Contact factory for availability and processing to MIL-STD-883 and DESC-SMD.

Chip Topography

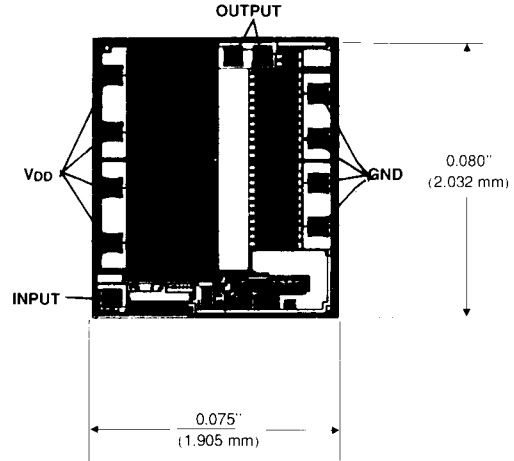

TRANSISTOR COUNT: 16;
SUBSTRATE CONNECTED TO V_{DD} .

Maxim cannot assume responsibility for use of any circuitry other than circuitry entirely embodied in a Maxim product. No circuit patent licenses are implied. Maxim reserves the right to change the circuitry and specifications without notice at any time.

6 Maxim Integrated Products, 120 San Gabriel Drive, Sunnyvale, CA 94086 (408) 737-7600

© 1992 Maxim Integrated Products

Printed USA

MAXIM is a registered trademark of Maxim Integrated Products.



SITE
SEARCH
PART NO.
SEARCH

WHAT'S NEW

PRODUCTS

SOLUTIONS

DESIGN

APPNOTES

SUPPORT

BUY

COMPANY

MEMBERS

MAX4420

Part Number Table

Notes:

1. See the [MAX4420 QuickView Data Sheet](#) for further information on this product family or download the [MAX4420 full data sheet](#) (PDF, 248kB).
2. Other options and links for purchasing parts are listed at: <http://www.maxim-ic.com/sales>.
3. [Didn't Find What You Need?](#) Ask our applications engineers. Expert assistance in finding parts, usually within one business day.
4. Part number suffixes: T or T&R = tape and reel; + = RoHS/lead-free; # = RoHS/lead-exempt. More: See [full data sheet](#) or [Part Naming Conventions](#).
5. * Some packages have variations, listed on the drawing. "PkgCode/Variation" tells which variation the product uses.

Part Number	Free Sample	Buy Direct	Package: TYPE PINS SIZE DRAWING CODE/VAR *	Temp	RoHS/Lead-Free? Materials Analysis
MAX4420EJA			Ceramic DIP;8 pin;.300" Dwg: 21-0045A (PDF) Use pkgcode/variation: J8-2*	-40C to +85C	RoHS/Lead-Free: No Materials Analysis
MAX4420MJA			Ceramic DIP;8 pin;.300" Dwg: 21-0045A (PDF) Use pkgcode/variation: J8-2*	-55C to +125C	RoHS/Lead-Free: No Materials Analysis
MAX4420MJA/883B			Ceramic DIP;8 pin;.300" Dwg: 21-0045A (PDF) Use pkgcode/variation: J8-2*	-55C to +125C	RoHS/Lead-Free: No Materials Analysis
MAX4420C/D					RoHS/Lead-Free: No
MAX4420CPA+			PDIP;8 pin;.300" Dwg: 21-0043D (PDF) Use pkgcode/variation: P8+1*	0C to +70C	RoHS/Lead-Free: Yes Materials Analysis
MAX4420CPA			PDIP;8 pin;.300" Dwg: 21-0043D (PDF) Use pkgcode/variation: P8-1*	0C to +70C	RoHS/Lead-Free: No Materials Analysis
MAX4420EPA+			PDIP;8 pin;.300" Dwg: 21-0043D (PDF) Use pkgcode/variation: P8+1*	-40C to +85C	RoHS/Lead-Free: Yes Materials Analysis

MAX4420EPA			PDIP;8 pin;.300" Dwg: 21-0043D (PDF) Use pkgcode/variation: P8-1*	-40C to +85C	RoHS/Lead-Free: No Materials Analysis
MAX4420CSA+T			SOIC;8 pin;.150" Dwg: 21-0041B (PDF) Use pkgcode/variation: S8+5*	0C to +70C	RoHS/Lead-Free: Yes Materials Analysis
MAX4420CSA+			SOIC;8 pin;.150" Dwg: 21-0041B (PDF) Use pkgcode/variation: S8+5*	0C to +70C	RoHS/Lead-Free: Yes Materials Analysis
MAX4420CSA-T			SOIC;8 pin;.150" Dwg: 21-0041B (PDF) Use pkgcode/variation: S8-5*	0C to +70C	RoHS/Lead-Free: No Materials Analysis
MAX4420CSA			SOIC;8 pin;.150" Dwg: 21-0041B (PDF) Use pkgcode/variation: S8-5*	0C to +70C	RoHS/Lead-Free: No Materials Analysis
MAX4420ESA+T			SOIC;8 pin;.150" Dwg: 21-0041B (PDF) Use pkgcode/variation: S8+5*	-40C to +85C	RoHS/Lead-Free: Yes Materials Analysis
MAX4420ESA-T			SOIC;8 pin;.150" Dwg: 21-0041B (PDF) Use pkgcode/variation: S8-5*	-40C to +85C	RoHS/Lead-Free: No Materials Analysis
MAX4420ESA			SOIC;8 pin;.150" Dwg: 21-0041B (PDF) Use pkgcode/variation: S8-5*	-40C to +85C	RoHS/Lead-Free: No Materials Analysis
MAX4420ESA+			SOIC;8 pin;.150" Dwg: 21-0041B (PDF) Use pkgcode/variation: S8+5*	-40C to +85C	RoHS/Lead-Free: Yes Materials Analysis

[Didn't Find What You Need?](#)

[CONTACT US: SEND US AN EMAIL](#)