

**IRS212(7, 71, 8, 81)(S)PbF**

**CURRENT SENSING SINGLE CHANNEL DRIVER**

**Features**

- Floating channel designed for bootstrap operation  
Fully operational to +600 V  
Tolerant to negative transient voltage dV/dt immune
- Application-specific gate drive range:  
Motor Drive: 12 V to 20 V (IRS2127/IRS2128)  
Automotive: 9 V to 20 V (IRS21271/IRS21281)
- Undervoltage lockout
- 3.3 V, 5 V, and 15 V input logic compatible
- FAULT lead indicates shutdown has occurred
- Output in phase with input (IRS2127/IRS21271)
- Output out of phase with input (IRS2128/IRS21281)
- RoHS compliant

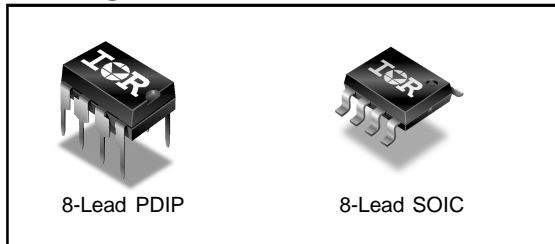
**Description**

The IRS2127/IRS2128/IRS21271/IRS21281 are high voltage, high speed power MOSFET and IGBT drivers. Proprietary HVIC and latch immune CMOS technologies enable ruggedized monolithic construction. The logic input is compatible with standard CMOS or LSTTL outputs, down to 3.3 V. The protection circuitry detects over-current in the driven power transistor and terminates the gate drive voltage. An open drain FAULT signal is provided to indicate that an over-current shutdown has occurred. The output driver features a high pulse current buffer stage designed for minimum cross-conduction. The floating channel can be used to drive an N-channel power MOSFET or IGBT in the high-side or low-side configuration which operates up to 600 V.

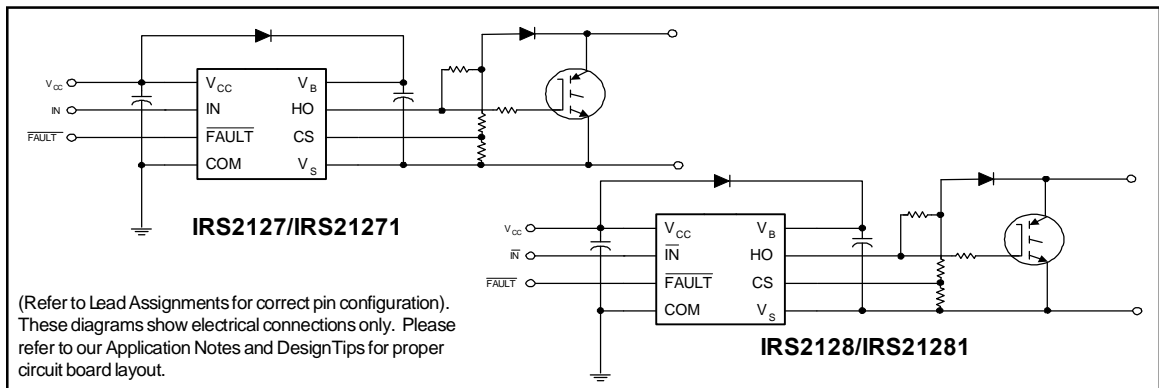
**Product Summary**

<b>V<sub>OFFSET</sub></b>	<b>600 V max.</b>
<b>I<sub>O+/-</sub></b>	<b>200 mA / 420 mA</b>
<b>V<sub>OUT</sub></b>	<b>12 V - 20V      9 V - 20 V</b> (IRS2127/IR2128)    (IRS21271/IR21281)
<b>V<sub>Csth</sub></b>	<b>250 mV or 1.8 V</b>
<b>ton/off (typ.)</b>	<b>150 ns &amp; 150 ns</b>

**Packages**



**Typical Connection**



## Absolute Maximum Ratings

Absolute maximum ratings indicate sustained limits beyond which damage to the device may occur. All voltage parameters are absolute voltages referenced to COM. The thermal resistance and power dissipation ratings are measured under board mounted and still air conditions.

Symbol	Definition	Min.	Max.	Units	
V <sub>B</sub>	High-side floating supply voltage	-0.3	625	V	
V <sub>S</sub>	High-side floating offset voltage	V <sub>B</sub> - 25	V <sub>B</sub> + 0.3		
V <sub>HO</sub>	High-side floating output voltage	V <sub>S</sub> - 0.3	V <sub>B</sub> + 0.3		
V <sub>CC</sub>	Logic supply voltage	-0.3	25		
V <sub>IN</sub>	Logic input voltage	-0.3	V <sub>CC</sub> + 0.3		
V <sub>FLT</sub>	$\overline{\text{FAULT}}$ output voltage	-0.3	V <sub>CC</sub> + 0.3		
V <sub>CS</sub>	Current sense voltage	V <sub>S</sub> - 0.3	V <sub>B</sub> + 0.3		
dV <sub>S</sub> /dt	Allowable offset supply voltage transient	—	50	V/ns	
P <sub>D</sub>	Package power dissipation @ T <sub>A</sub> ≤ +25 °C	8-Lead DIP	—	1.0	W
		8-Lead SOIC	—	0.625	
R <sub>thJA</sub>	Thermal resistance, junction to ambient	8-Lead DIP	—	125	°C/W
		8-Lead SOIC	—	200	
T <sub>J</sub>	Junction temperature	—	150	°C	
T <sub>S</sub>	Storage temperature	-55	150		
T <sub>L</sub>	Lead temperature (soldering, 10 seconds)	—	300		

## Recommended Operating Conditions

The input/output logic timing diagram is shown in Fig. 1. For proper operation the device should be used within the recommended conditions. The V<sub>S</sub> offset rating is tested with all supplies biased at 15 V differential.

Symbol	Definition	Min.	Max.	Units	
V <sub>B</sub>	High-side floating supply voltage	(IRS2127/IRS2128)	V <sub>S</sub> + 12	V <sub>S</sub> + 20	V
		(IRS21271/IRS21281)	V <sub>S</sub> + 9	V <sub>S</sub> + 20	
V <sub>S</sub>	High-side floating offset voltage	Note 1	600		
V <sub>HO</sub>	High-side floating output voltage	V <sub>S</sub>	V <sub>B</sub>		
V <sub>CC</sub>	Logic supply voltage	10	20		
V <sub>IN</sub>	Logic input voltage	0	V <sub>CC</sub>		
V <sub>FLT</sub>	$\overline{\text{FAULT}}$ output voltage	0	V <sub>CC</sub>		
V <sub>CS</sub>	Current sense signal voltage	V <sub>S</sub>	V <sub>S</sub> + 5		
T <sub>A</sub>	Ambient temperature	-40	125	°C	

Note 1: Logic operational for V<sub>S</sub> of -5 V to +600 V. Logic state held for V<sub>S</sub> of -5 V to -V<sub>BS</sub>. (Please refer to the Design Tip DT97-3 for more details).

## Dynamic Electrical Characteristics

$V_{BIAS}$  ( $V_{CC}$ ,  $V_{BS}$ ) = 15 V,  $C_L$  = 1000 pF and  $T_A$  = 25 °C unless otherwise specified. The dynamic electrical characteristics are measured using the test circuit shown in Fig. 3.

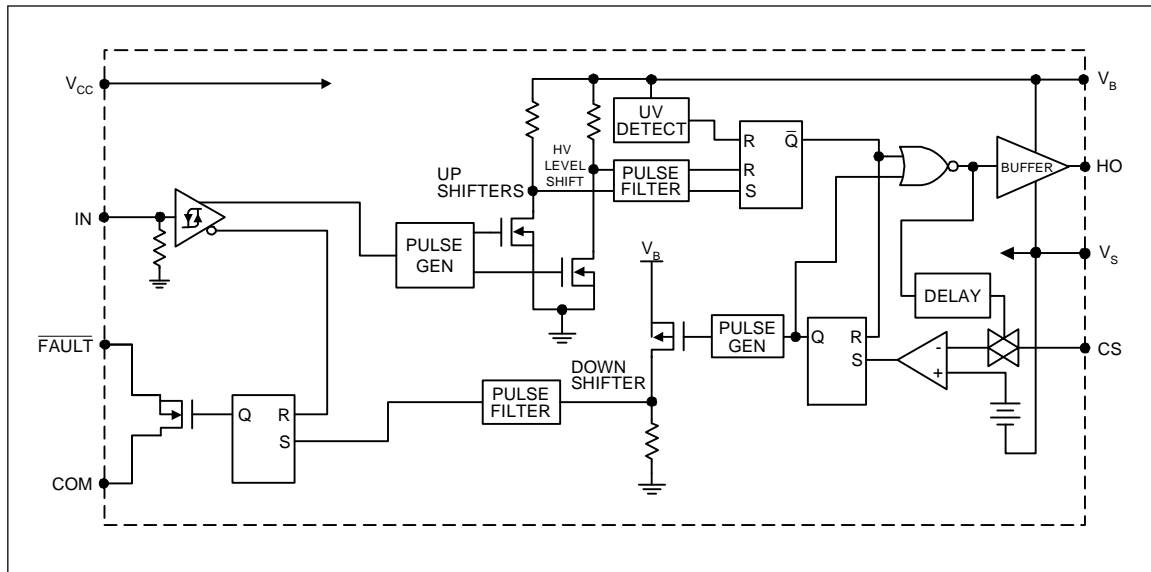
Symbol	Definition	Min.	Typ.	Max.	Units	Test Conditions
$t_{on}$	Turn-on propagation delay	—	150	200	ns	$V_S = 0$ V
$t_{off}$	Turn-off propagation delay	—	150	200		$V_S = 600$ V
$t_r$	Turn-on rise time	—	80	130		
$t_f$	Turn-off fall time	—	40	65		
$t_{bl}$	Start-up blanking time	550	750	950		
$t_{cs}$	CS shutdown propagation delay	—	65	360		
$t_{ft}$	CS to FAULT pull-up propagation delay	—	270	510		

## Static Electrical Characteristics

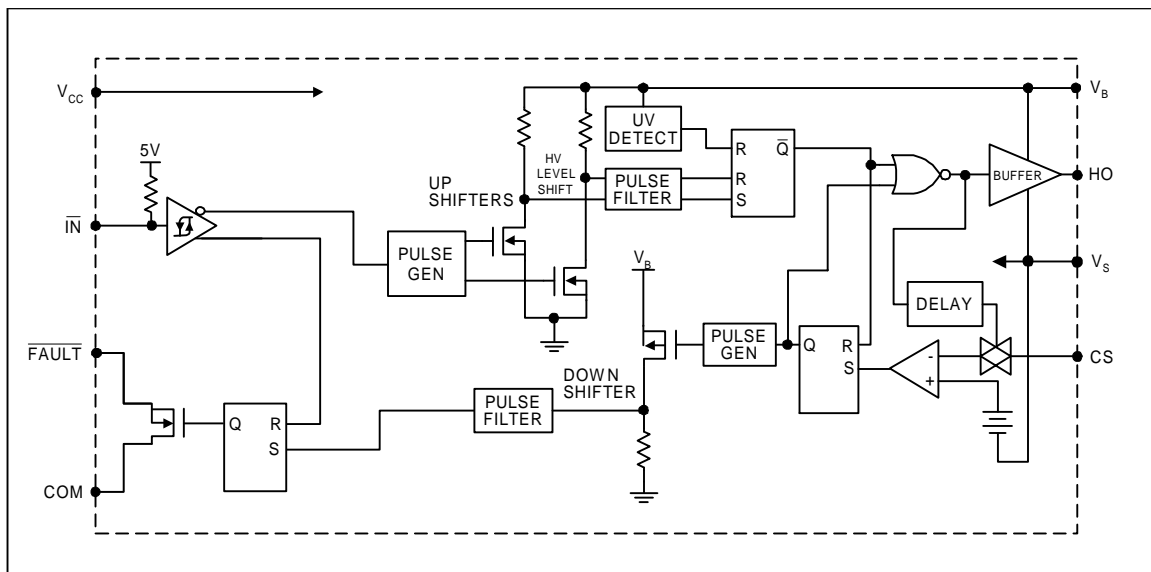
$V_{BIAS}$  ( $V_{CC}$ ,  $V_{BS}$ ) = 15 V and  $T_A$  = 25 °C unless otherwise specified. The  $V_{IN}$ ,  $V_{TH}$ , and  $I_{IN}$  parameters are referenced to COM. The  $V_O$  and  $I_O$  parameters are referenced to  $V_S$ .

Symbol	Definition	Min.	Typ.	Max.	Units	Test Conditions	
$V_{IH}$	Logic "1" input voltage (IRS2127/IRS21271)	2.5	—	—	V	$V_{CC} = 10$ V to 20 V	
	Logic "0" input voltage (IRS2128/IRS21281)						
$V_{IL}$	Logic "0" input voltage (IRS2127/IRS21271)	—	—	0.8	V		
	Logic "1" input voltage (IRS2128/IRS21281)						
$V_{CSTH+}$	CS input positive going threshold (IRS2127/IRS2128)	180	250	320	mV		
	(IRS21271/IRS21281)	1.5	1.8	2.1	V		
$V_{OH}$	High level output voltage, $V_{BIAS} - V_O$	—	0.05	0.2	V		$I_O = 2$ mA
$V_{OL}$	Low level output voltage, $V_O$	—	0.02	0.1	V		
$I_{LK}$	Offset supply leakage current	—	—	50	$\mu$ A		$V_B = V_S = 600$ V
$I_{QBS}$	Quiescent $V_{BS}$ supply current	—	300	800			$V_{IN} = 0$ V or 5 V
$I_{QCC}$	Quiescent $V_{CC}$ supply current	—	60	120		$V_{IN} = 5$ V	
$I_{IN+}$	Logic "1" input bias current	—	7.0	15		$V_{IN} = 0$ V	
$I_{IN-}$	Logic "0" input bias current	—	—	5.0		$V_{CS} = 3$ V	
$I_{CS+}$	"High" CS bias current	—	—	5.0		$V_{CS} = 0$ V	
$V_{BSUV+}$	$V_{BS}$ supply undervoltage positive going threshold	(IRS2127/IRS2128)	8.8	10.3		11.8	V
		(IRS21271/IRS21281)	6.3	7.2		8.2	
$V_{BSUV-}$	$V_{BS}$ supply undervoltage negative going threshold	(IRS2127/IRS2128)	7.5	9.0	10.6		
		(IRS21271/IRS21281)	6.0	6.8	7.7		
$I_{O+}$	Output high short circuit pulsed current	200	290	—	mA	$V_O = 0$ V, $V_{IN} = 5$ V $PW \leq 10$ $\mu$ s	
$I_{O-}$	Output low short circuit pulsed current	420	600	—		$V_O = 15$ V, $V_{IN} = 0$ V $PW \leq 10$ $\mu$ s	
$R_{on,FLT}$	FAULT - low on resistance	—	125	—	$\Omega$		

**Functional Block Diagram IRS2127/IRS21271**



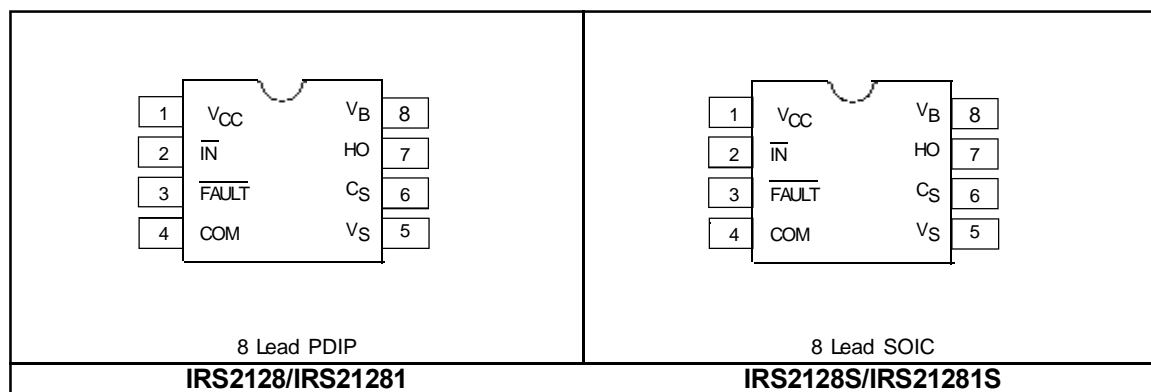
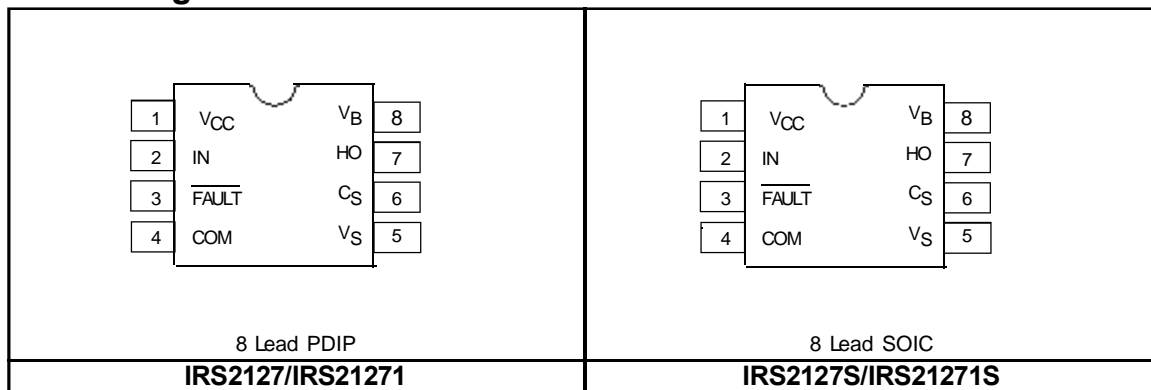
**Functional Block Diagram IRS2128/IRS21281**

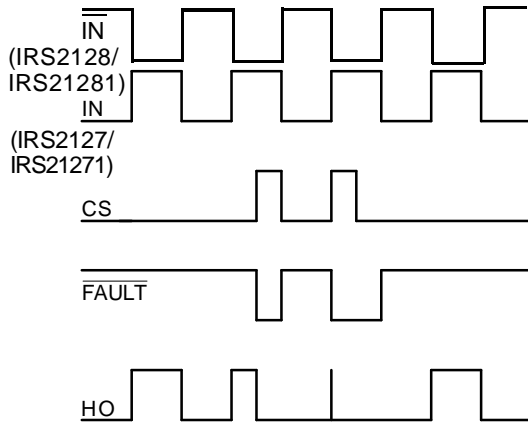


**Lead Definitions**

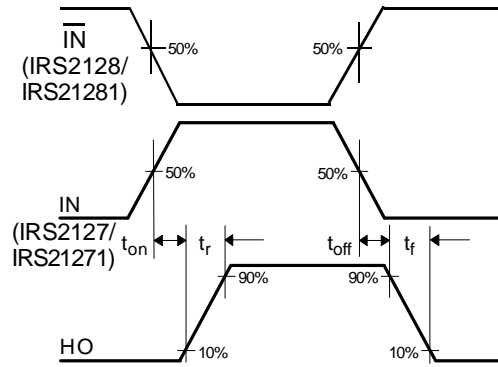
Symbol	Description
V <sub>CC</sub>	Logic and gate drive supply
IN	Logic input for gate driver output (HO), in phase with HO (IRS2127/IRS21271) out of phase with HO (IRS2128/IRS21281)
FAULT	Indicates over-current shutdown has occurred, negative logic
COM	Logic ground
V <sub>B</sub>	High-side floating supply
HO	High-side gate drive output
V <sub>S</sub>	High-side floating supply return
CS	Current sense input to current sense comparator

**Lead Assignments**

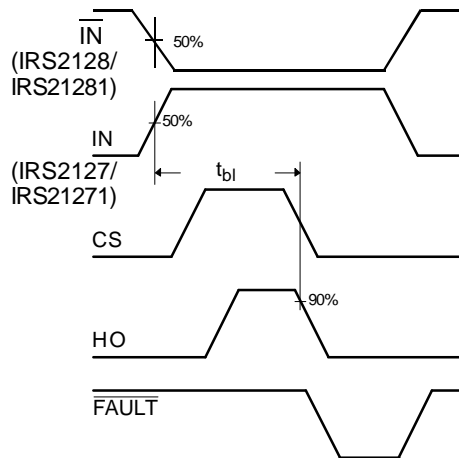




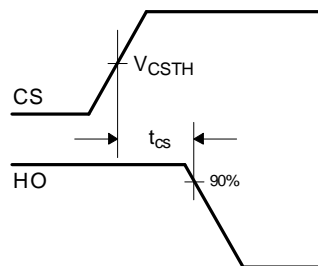
**Figure 1. Input/Output Timing Diagram**



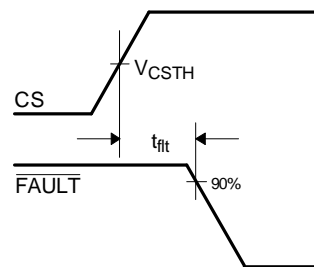
**Figure 2. Switching Time Waveform Definition**



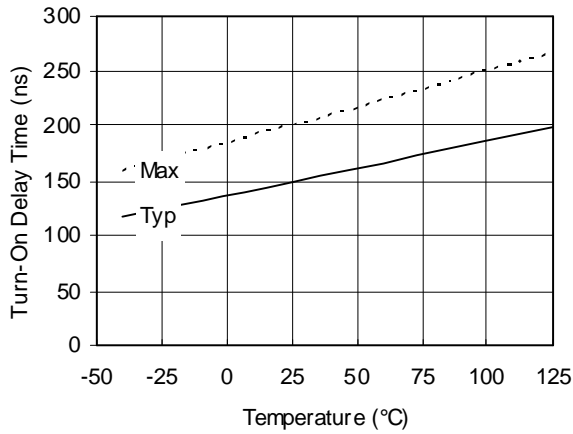
**Figure 3. Start-Up Blanking Time Waveform Definitions**



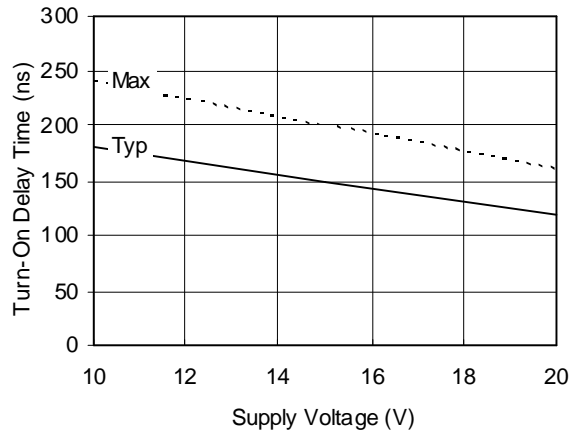
**Figure 4. CS Shutdown Waveform Definitions**



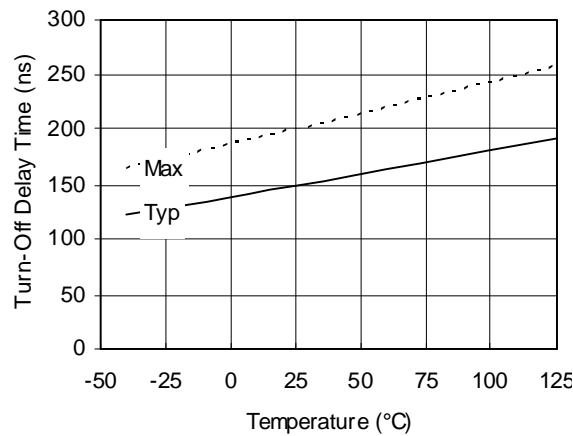
**Figure 5. CS to FAULT Waveform Definitions**



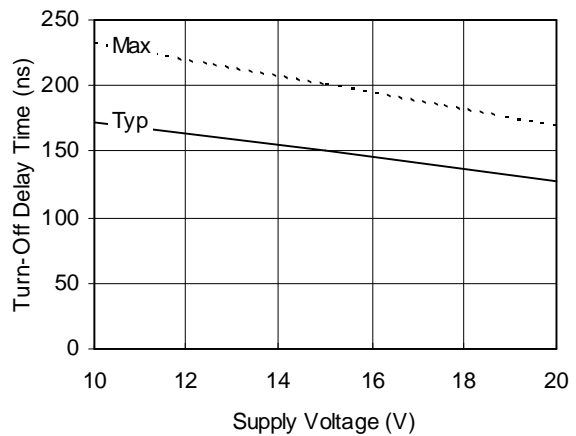
**Figure 6A. Turn-On Delay Time vs. Temperature**



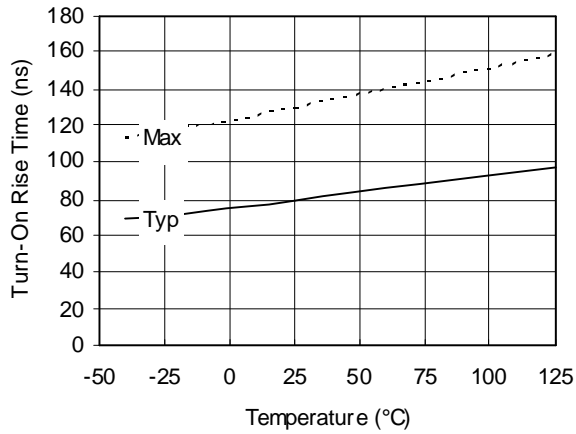
**Figure 6B. Turn-On Delay Time vs. Voltage**



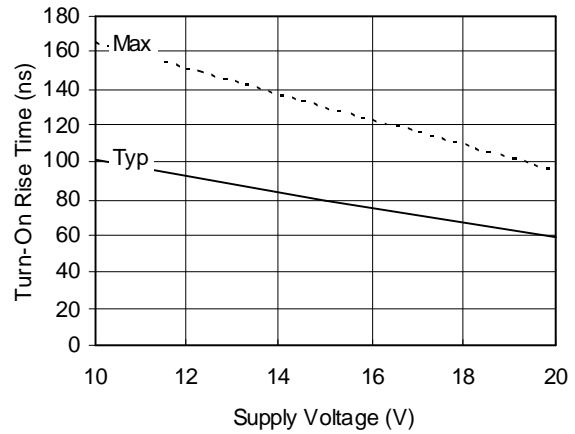
**Figure 7A. Turn-Off Delay Time vs. Temperature**



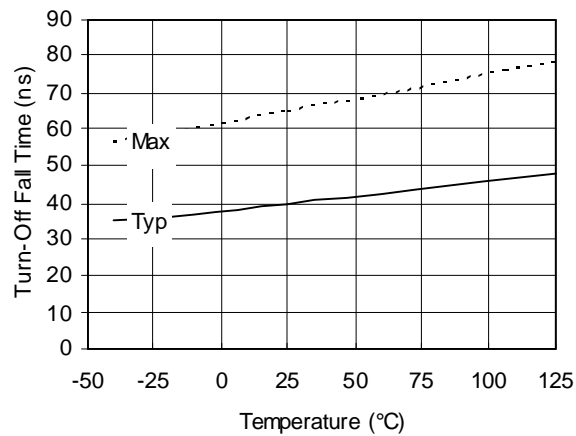
**Figure 7B. Turn-Off Delay Time vs. Voltage**



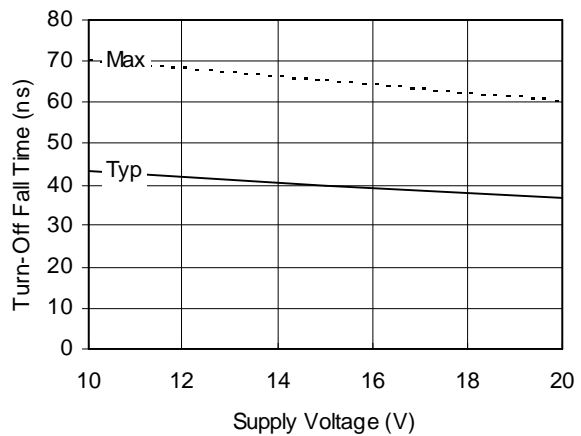
**Figure 8A. Turn-On Rise Time vs. Temperature**



**Figure 8B. Turn-On Rise Time vs. Voltage**

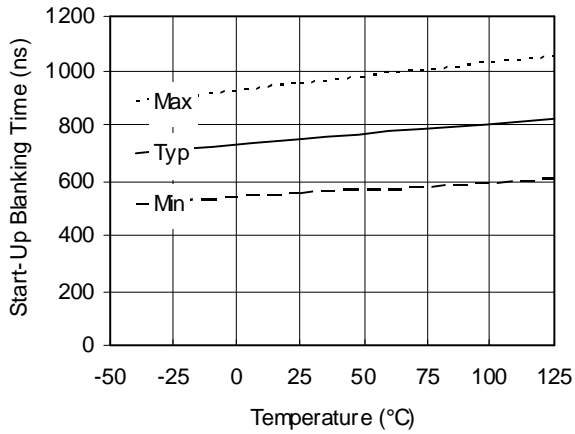


**Figure 9A. Turn-Off Fall Time vs. Temperature**

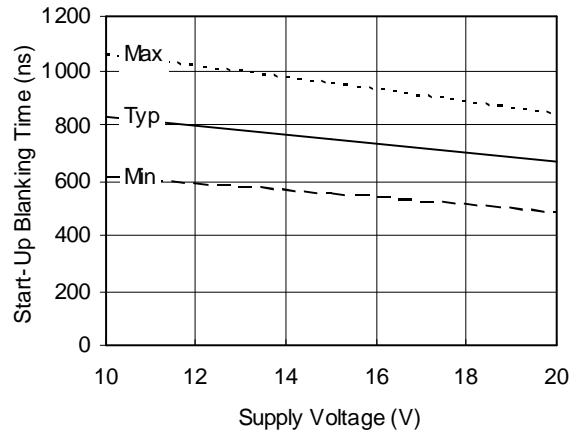


**Figure 9B. Turn-Off Fall Time vs. Voltage**

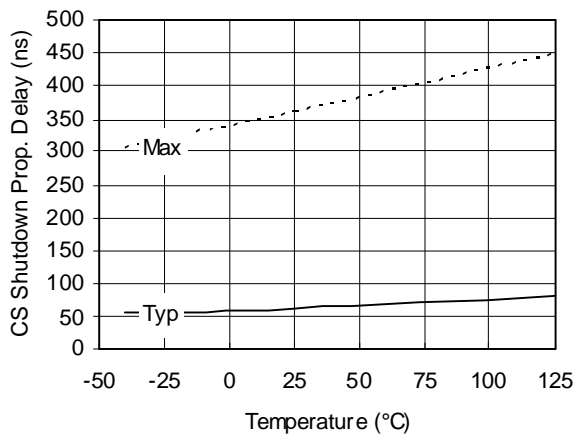




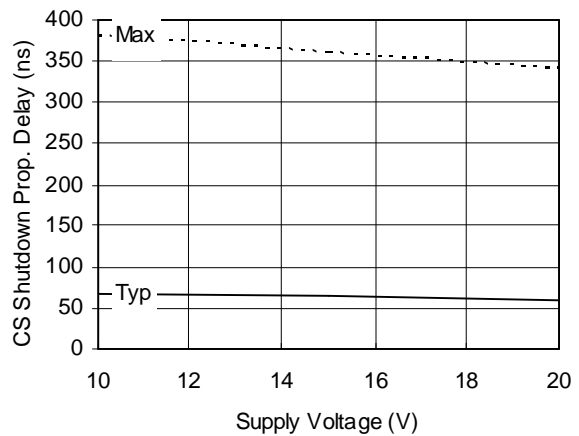
**Figure 10A. Start-Up Blanking Time vs. Temperature**



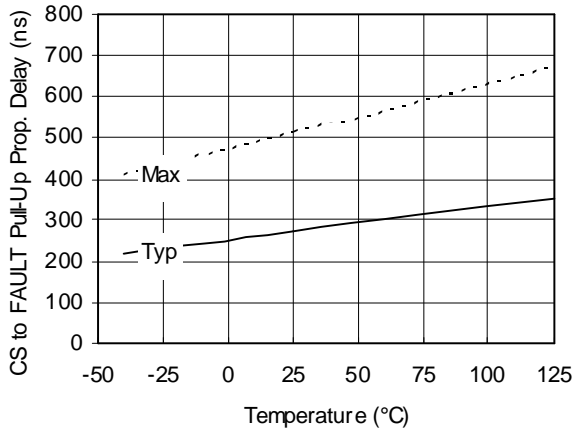
**Figure 10B. Start-Up Blanking Time vs. Voltage**



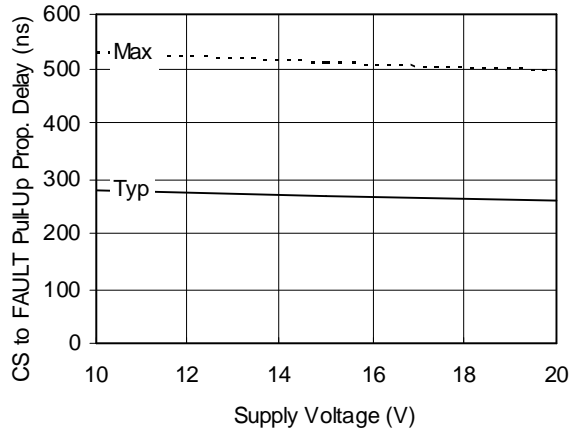
**Figure 11A. CS Shutdown Prop. Delay vs. Temperature**



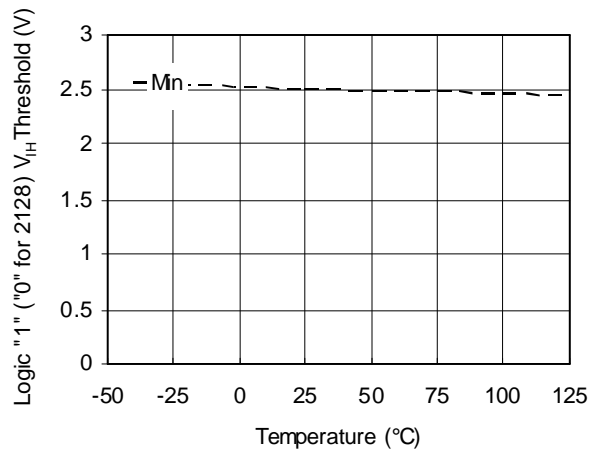
**Figure 11B. CS Shutdown Prop. Delay vs. Voltage**



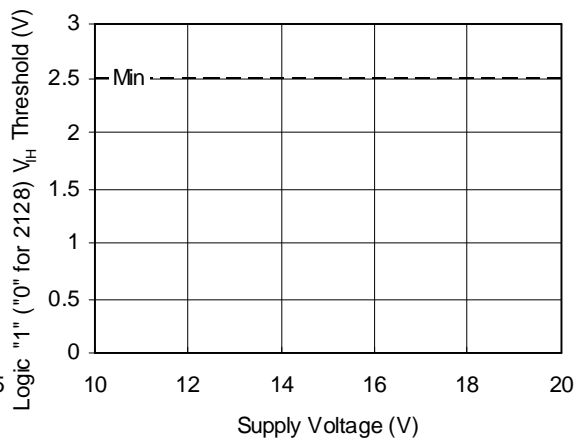
**Figure 12A. CS to FAULT Pull-Up Prop. Delay vs. Temperature**



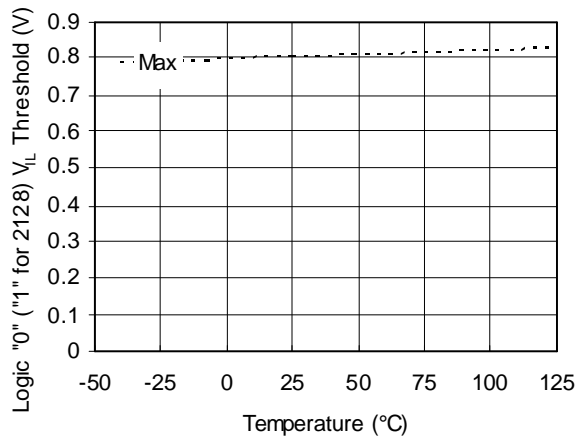
**Figure 12B. CS to FAULT Pull-Up Prop. Delay vs. Voltage**



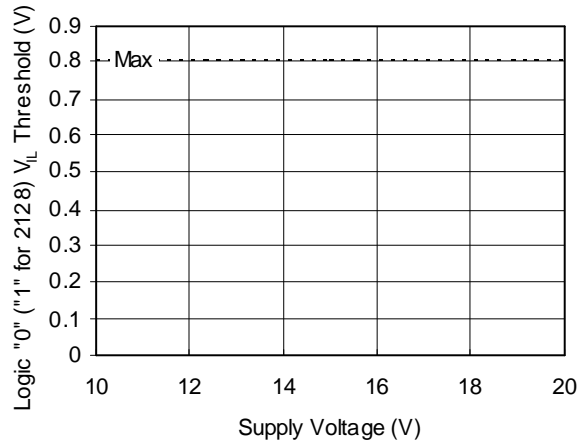
**Figure 13A. Logic "1" ("0" for 2128)  $V_{IH}$  Threshold vs. Temperature**



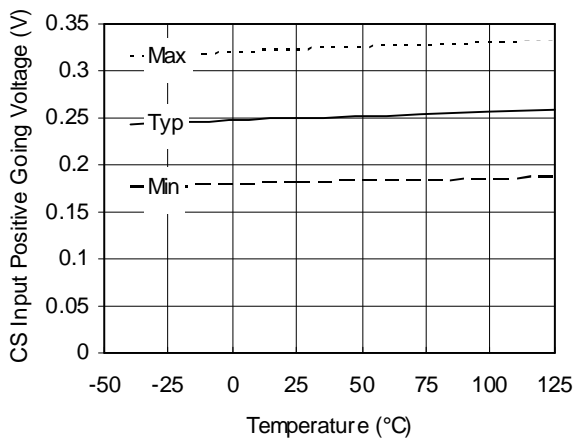
**Figure 13B. Logic "1" ("0" for 2128)  $V_{IH}$  Threshold vs. Voltage**



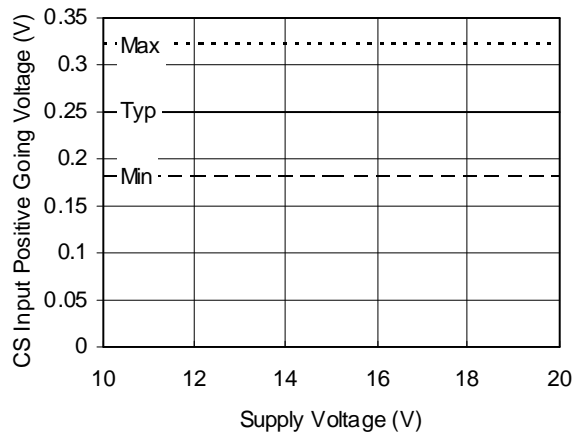
**Figure 14A. Logic "0" ("1" for 2128)  $V_{IL}$  Threshold vs. Temperature**



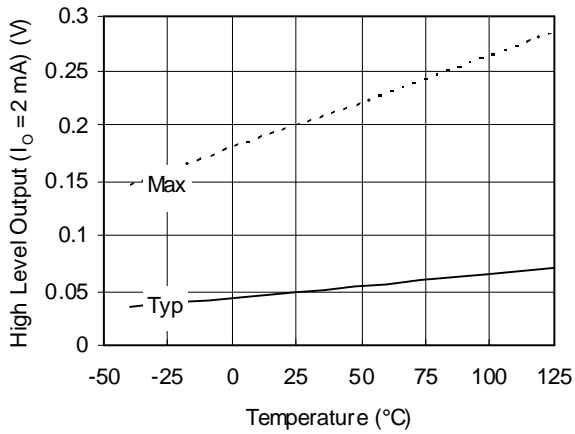
**Figure 14B. Logic "0" ("1" for 2128)  $V_{IL}$  Threshold vs. Voltage**



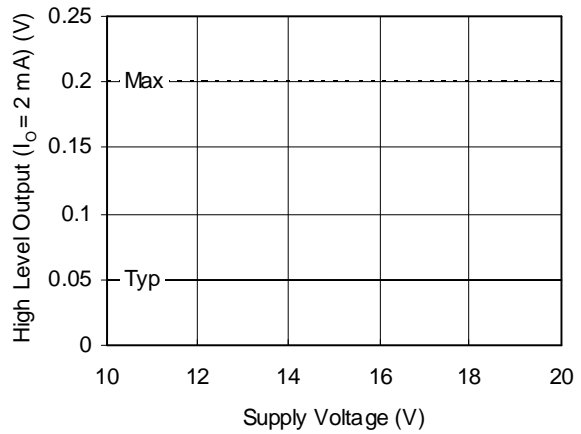
**Figure 15A. CS Input Positive Going Voltage vs. Temperature**



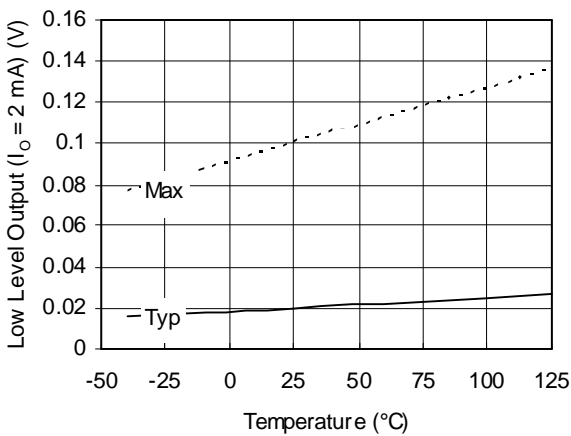
**Figure 15B. CS Input Positive Going Voltage vs. Voltage**



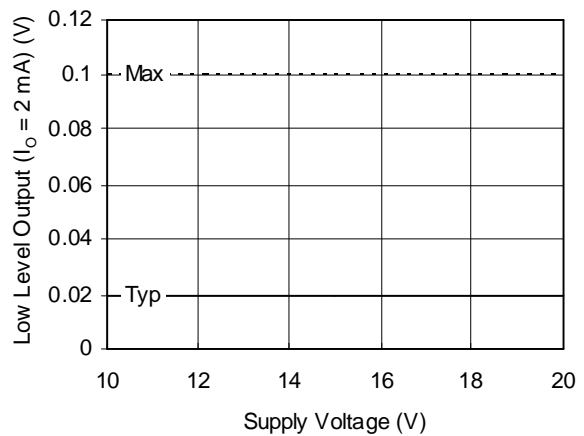
**Figure 16A. High Level Output ( $I_o = 2 \text{ mA}$ ) vs. Temperature**



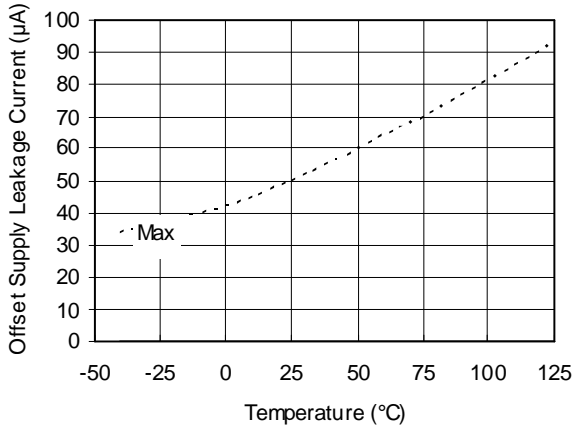
**Figure 16B. High Level Output ( $I_o = 2 \text{ mA}$ ) vs. Voltage**



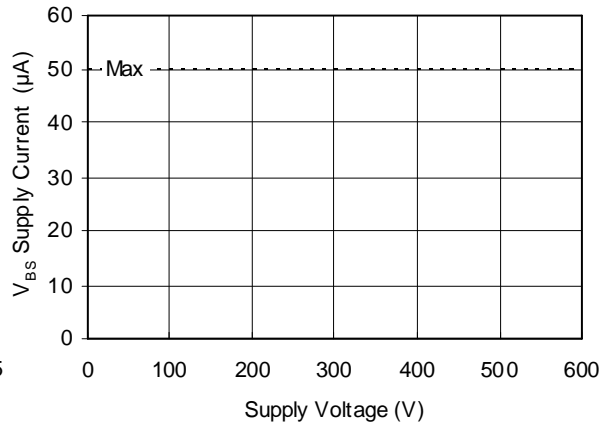
**Figure 17A. Low Level Output ( $I_o = 2 \text{ mA}$ ) vs. Temperature**



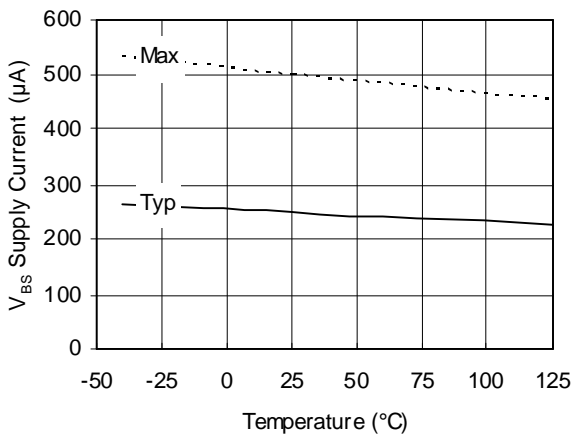
**Figure 17B. Low Level Output ( $I_o = 2 \text{ mA}$ ) vs. Voltage**



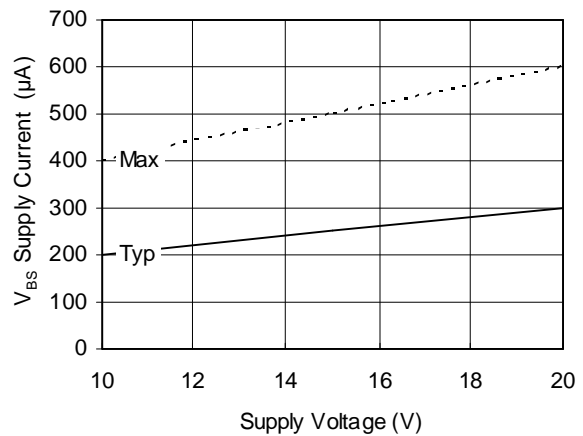
**Figure 18A. Offset Supply Leakage Current vs. Temperature**



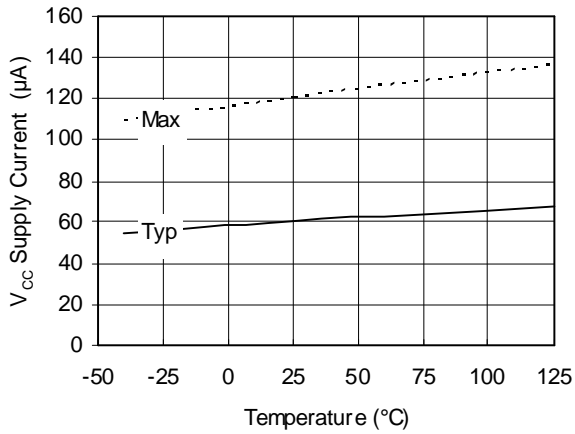
**Figure 18B. High-Side Floating Well Offset Supply Leakage vs. Voltage**



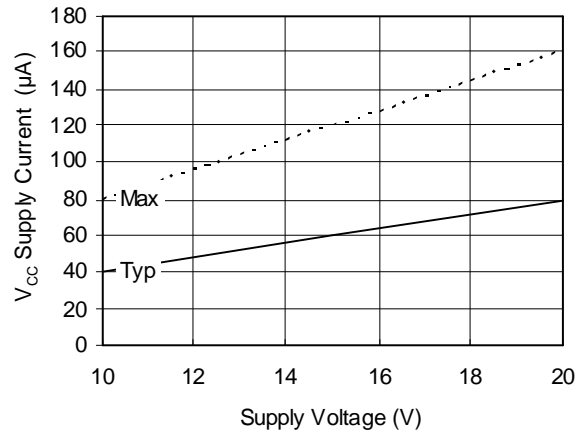
**Figure 19A. V<sub>BS</sub> Supply Current vs. Temperature**



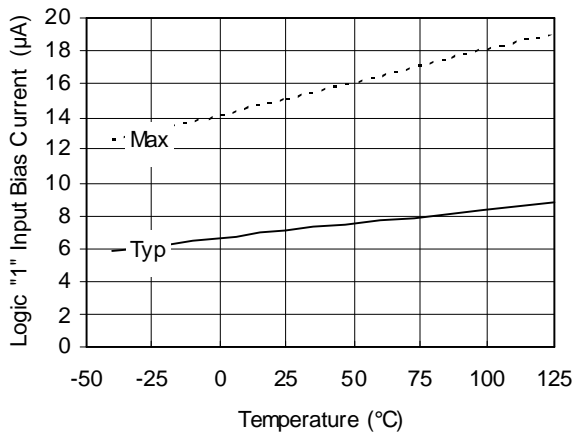
**Figure 19B. V<sub>BS</sub> Supply Current vs. Voltage**



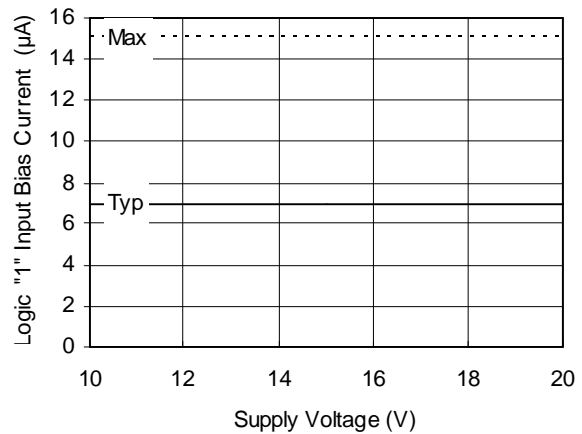
**Figure 20A. V<sub>CC</sub> Supply Current vs. Temperature**



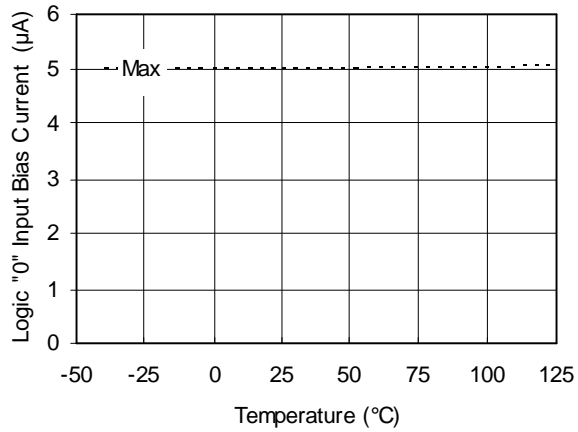
**Figure 20B. V<sub>CC</sub> Supply Current vs. Voltage**



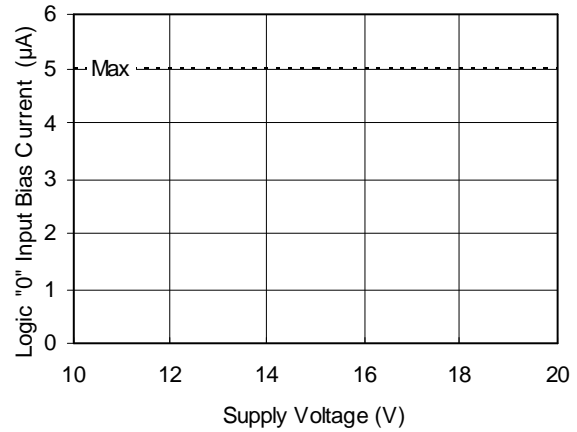
**Figure 21A. Logic "1" Input Bias Current vs. Temperature**



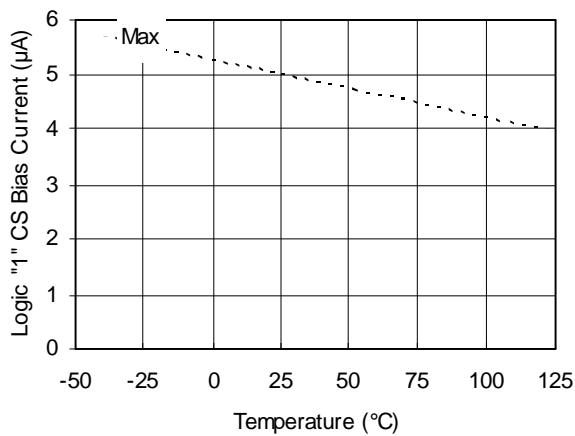
**Figure 21B. Logic "1" Input Bias Current vs. Voltage**



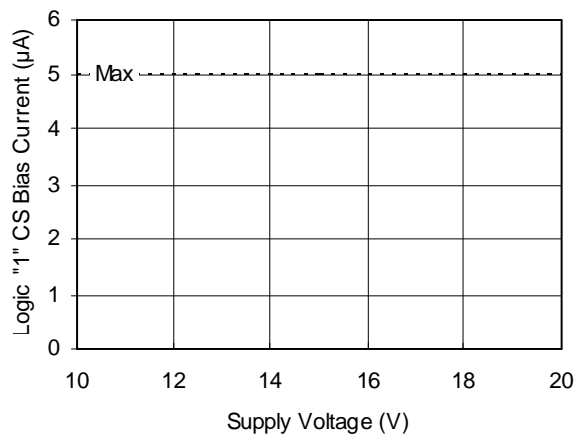
**Figure 22A. Logic "0" Input Bias Current vs. Temperature**



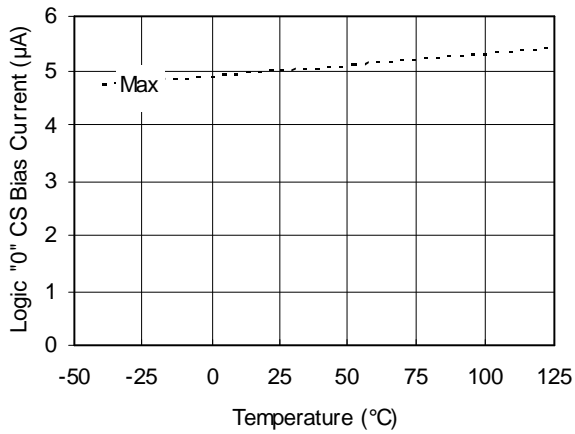
**Figure 22B. Logic "0" Input Bias Current vs. Voltage**



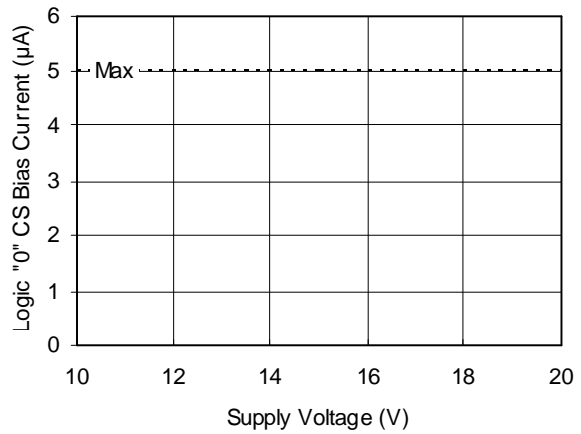
**Figure 23A. Logic "1" CS Bias Current vs. Temperature**



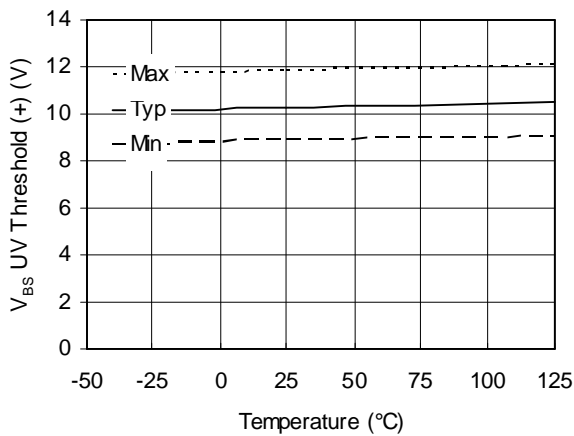
**Figure 23B. Logic "1" CS Bias Current vs. Voltage**



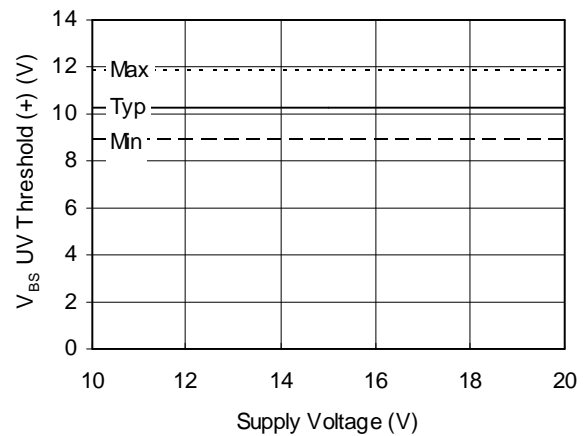
**Figure 24A. Logic "0" CS Bias Current vs. Temperature**



**Figure 24B. Logic "0" CS Bias Current vs. Voltage**

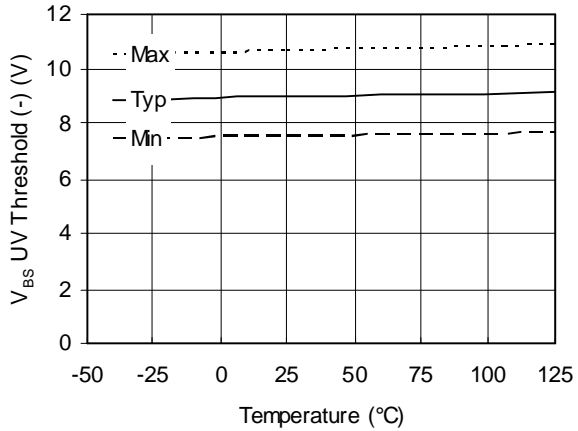


**Figure 25A. V<sub>BS</sub> UV Threshold (+) vs. Temperature**

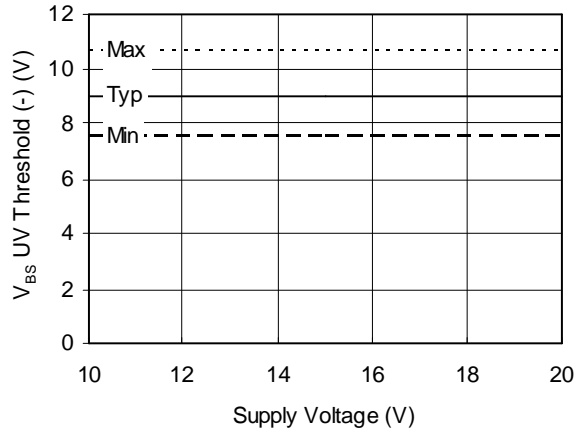


**Figure 25B. V<sub>BS</sub> UV Threshold (+) vs. Voltage**

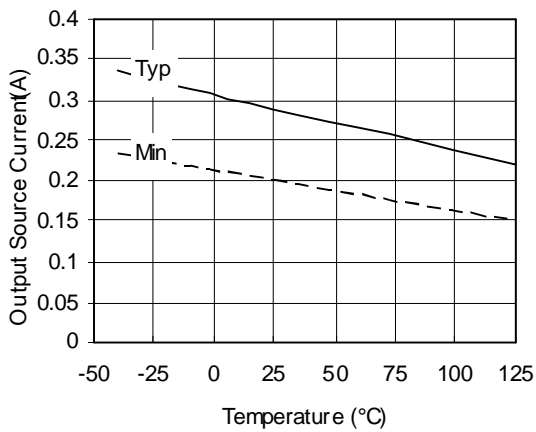




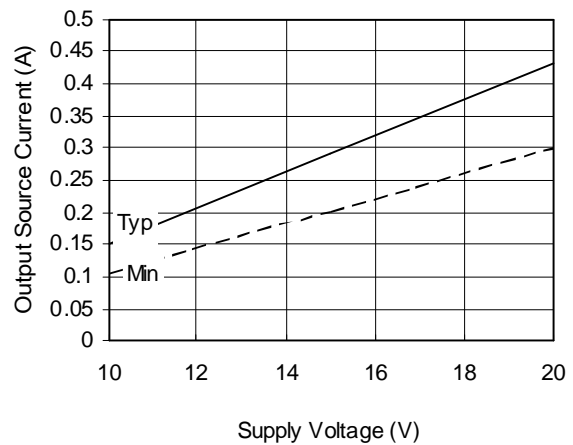
**Figure 26A.  $V_{BS}$  UV Threshold (-) vs. Temperature**



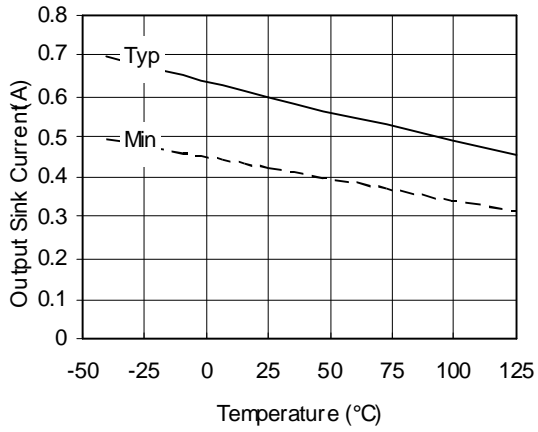
**Figure 26B.  $V_{BS}$  UV Threshold (-) vs. Voltage**



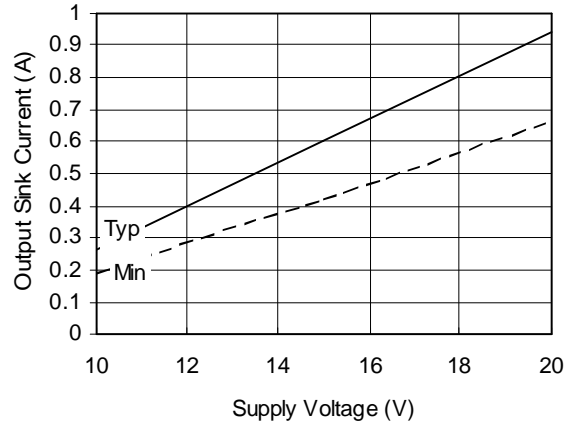
**Figure 27A. Output Source Current vs. Temperature**



**Figure 27B. Output Source Current vs. Voltage**

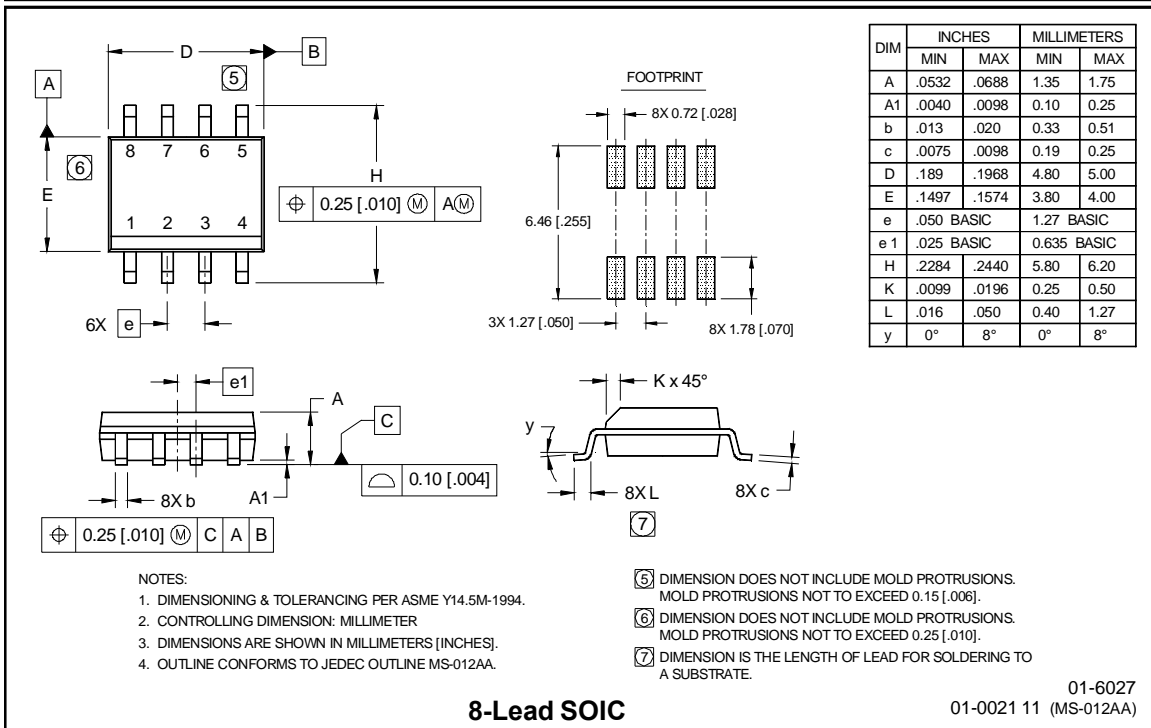
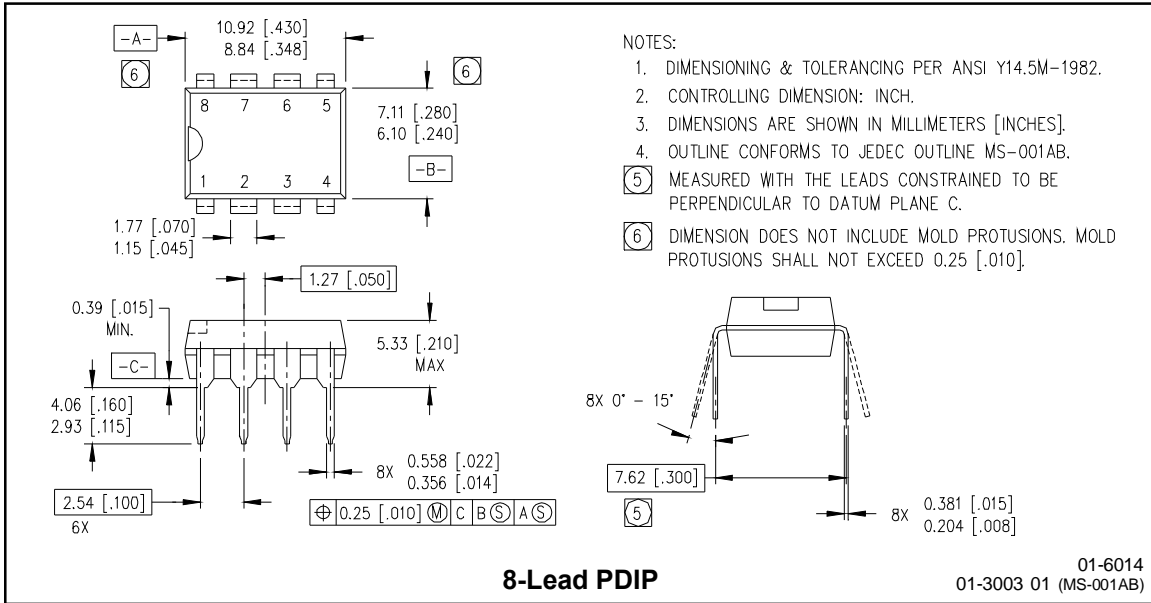


**Figure 28A. Output Sink Current vs. Temperature**

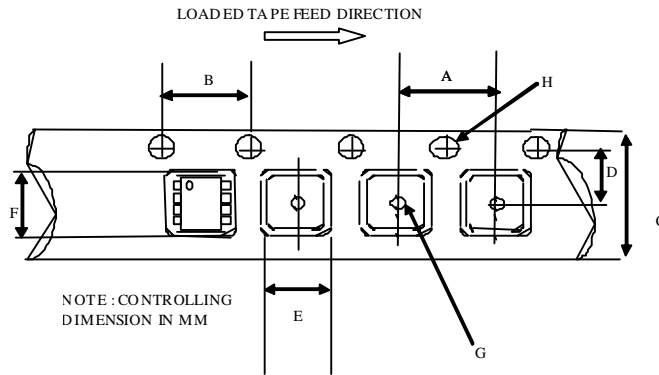


**Figure 28B. Output Sink Current vs. Voltage**

**Case outlines**

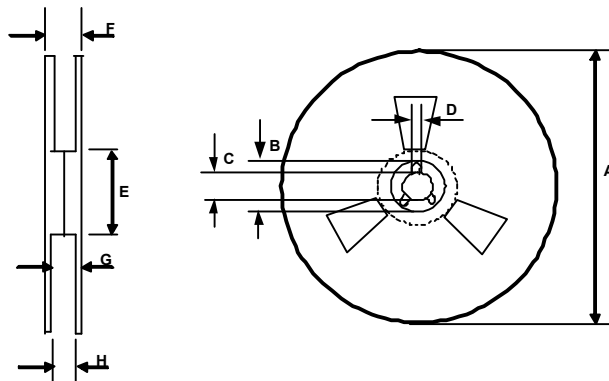


**Tape & Reel  
8-lead SOIC**



CARRIER TAPE DIMENSION FOR 8SOICN

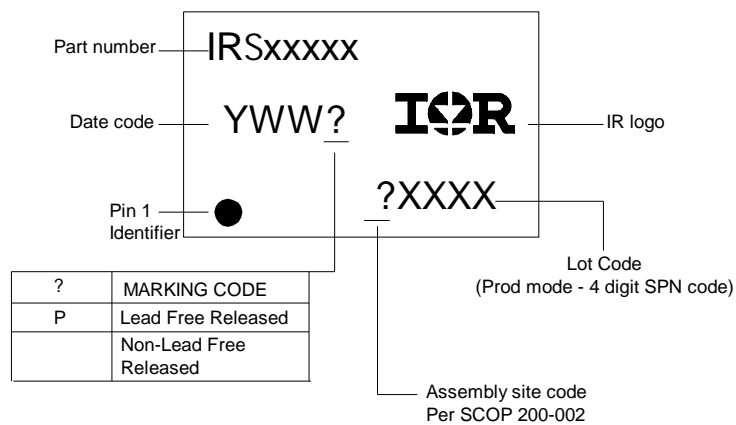
Code	Metric		Imperial	
	Min	Max	Min	Max
A	7.90	8.10	0.311	0.318
B	3.90	4.10	0.153	0.161
C	11.70	12.30	0.46	0.484
D	5.45	5.55	0.214	0.218
E	6.30	6.50	0.248	0.255
F	5.10	5.30	0.200	0.208
G	1.50	n/a	0.059	n/a
H	1.50	1.60	0.059	0.062



REEL DIMENSIONS FOR 8SOICN

Code	Metric		Imperial	
	Min	Max	Min	Max
A	329.60	330.25	12.976	13.001
B	20.95	21.45	0.824	0.844
C	12.80	13.20	0.503	0.519
D	1.95	2.45	0.767	0.096
E	98.00	102.00	3.858	4.015
F	n/a	18.40	n/a	0.724
G	14.50	17.10	0.570	0.673
H	12.40	14.40	0.488	0.566

**LEADFREE PART MARKING INFORMATION**



**ORDER INFORMATION**

8-Lead PDIP IRS2127PbF  
 8-Lead PDIP IRS21271PbF  
 8-Lead SOIC IRS2127SPbF  
 8-Lead SOIC IRS21271SPbF  
 8-Lead SOIC Tape & Reel IRS2127STRPbF  
 8-Lead SOIC Tape & Reel IRS21271STRPbF

8-Lead PDIP IRS2128PbF  
 8-Lead PDIP IRS21281PbF  
 8-Lead SOIC IRS2128SPbF  
 8-Lead SOIC IRS21281SPbF  
 8-Lead SOIC Tape & Reel IRS2128STRPbF  
 8-Lead SOIC Tape & Reel IRS21281STRPbF