

Quad smart power solid state relay for complete H-bridge configurations

Features

Type	$R_{DS(on)}$	I_{OUT}	V_{CC}
VN770K	220 m Ω ⁽¹⁾	9 A ⁽²⁾	36 V

1. Total resistance of one side in bridge configuration
2. Typical current limitation value

- Suited as low voltage bridge
- Linear current limitation
- Very low standby power dissipation
- Short circuit protected
- Status flag diagnostic (open drain)
- Integrated clamping circuits
- Undervoltage protection
- ESD protection

Description

The VN770K is a device formed by three monolithic chips housed in a standard SO-28 package: a double high side and two low side switches. Both the double high side and low side switches are made using STMicroelectronics VIPower™ M0-3 Technology.



SO-28

This device is suitable to drive a DC motor in a bridge configuration as well as to be used as a quad switch for any low voltage application.

The dual high side switches have built-in thermal shutdown to protect the chips from over temperature and current limiter blocks to protect the device from short circuit. Status output is provided to indicate open load in off and on-state and over temperature.

The low side switches are two OMNIFET II types (fully auto protected Power MOSFET in VIPower™ technology). They have built-in thermal shutdown, linear current limitation and overvoltage clamping. Fault feedback for thermal intervention can be detected by monitoring the voltage at the input pin.

Table 1. Device summary

Package	Order codes	
	Tube	Tape and reel
SO-28	VN770K	VN770K13TR

Contents

1	Block diagrams and pins descriptions	6
2	Electrical specifications	8
2.1	Thermal data	8
2.2	Absolute maximum ratings	8
2.3	Electrical characteristics for dual high side switch	9
2.4	Electrical characteristics for low side switches	11
2.5	Dual high-side switch timing data	14
2.6	Electrical characterization for dual high side switch	16
2.7	Electrical characterization for low side switches	19
3	Application recommendations	23
4	Thermal data	26
4.1	SO-28 thermal data	26
4.2	Thermal calculation in clockwise and anti-clockwise operation in steady state mode 27	
4.2.1	Thermal resistances definition	27
4.2.2	Thermal calculation in transient mode	27
4.2.3	Single pulse thermal impedance definition	27
4.2.4	Pulse calculation formula	27
5	Package mechanical data	30
5.1	SO-28 mechanical data	30
5.2	SO-28 tube shipment	31
5.3	Tape and reel shipment	31
6	Revision history	32

List of tables

Table 1.	Device summary	1
Table 2.	Pin definition and function.	7
Table 3.	Thermal data.	8
Table 4.	Dual high side switch	8
Table 5.	Low side switch.	8
Table 6.	Power outputs (per each channel)	9
Table 7.	Switching (per each channel) ($V_{CC}= 13V$)	10
Table 8.	Logic input (per each channel)	10
Table 9.	Status pin (per each channel)	10
Table 10.	Protections (per each channel)	10
Table 11.	Openload detection (per each channel)	11
Table 12.	Off-state	11
Table 13.	On-state	12
Table 14.	Dynamic	12
Table 15.	Switching	12
Table 16.	Source drain diode	13
Table 17.	Protections	13
Table 18.	Truth table.	14
Table 19.	Thermal calculation in clockwise and anti-clockwise operation in steady state mode	27
Table 20.	Thermal parameters	29
Table 21.	SO-28 mechanical data	30
Table 22.	Document revision history	32

List of figures

Figure 1.	Block diagram	6
Figure 2.	Connection diagram	7
Figure 3.	Switching time waveforms	14
Figure 4.	Open-load status timing (with external pull-up)	15
Figure 5.	Over temperature status timing	15
Figure 6.	Off-state output current	16
Figure 7.	Input clamp voltage	16
Figure 8.	High level input current	16
Figure 9.	Input high level voltage	16
Figure 10.	Input low level voltage	16
Figure 11.	Input hysteresis voltage	16
Figure 12.	Overvoltage shutdown	17
Figure 13.	I_{LIM} vs T_{case}	17
Figure 14.	Turn-on voltage slope	17
Figure 15.	Turn-off voltage slope	17
Figure 16.	On-state resistance vs T_{case}	17
Figure 17.	On-state resistance vs V_{CC}	17
Figure 18.	Status leakage current	18
Figure 19.	Status low output voltage	18
Figure 20.	Openload on-state detection threshold	18
Figure 21.	Openload off-state voltage detection threshold	18
Figure 22.	Status clamp voltage	18
Figure 23.	Static drain source on resistance	19
Figure 24.	Derating curve	19
Figure 25.	Transconductance	19
Figure 26.	Transfer characteristics	19
Figure 27.	Turn-on current slope ($V_{in}=5V$)	19
Figure 28.	Turn-on current slope ($V_{in}=3.5V$)	19
Figure 29.	Input voltage vs input charge	20
Figure 30.	Capacitance variations	20
Figure 31.	Switching time resistive load ($V_{in}=5V$)	20
Figure 32.	Switching time resistive load ($R_g=10\Omega$)	20
Figure 33.	Output characteristics	20
Figure 34.	Step response current limit	20
Figure 35.	Source drain diode forward characteristics	21
Figure 36.	Static drain source on resistance vs I_d	21
Figure 37.	Static drain source on resistance vs input voltage ($I_d=7A$)	21
Figure 38.	Static drain source on resistance vs input voltage	21
Figure 39.	Normalized input threshold voltage vs temperature	21
Figure 40.	Normalized on resistance vs temperature	21
Figure 41.	Turn-off drain source voltage slope ($V_{in}=3.5V$)	22
Figure 42.	Turn-off drain source voltage slope ($V_{in}=5V$)	22
Figure 43.	Current limit vs junction temperature	22
Figure 44.	Application diagram bridge drivers	23
Figure 45.	Recommended motor operation	24
Figure 46.	Waveforms	25
Figure 47.	SO-28 PC board	26
Figure 48.	Chipset configuration	26

Figure 49.	Auto and mutual $R_{thj-amb}$ vs PCB copper area in open box free air condition	26
Figure 50.	SO-28 HSD thermal impedance junction ambient single pulse	28
Figure 51.	SO-28 LSD thermal impedance junction ambient single pulse.	28
Figure 52.	Thermal fitting model of an H-bridge in SO-28	29
Figure 53.	SO-28 package outline	30
Figure 54.	Tube dimensions (no suffix)	31
Figure 55.	Tape and reel dimensions (suffix "13TR")	31

Obsolete Product(s) - Obsolete Product(s)

1 Block diagrams and pins descriptions

Figure 1. Block diagram

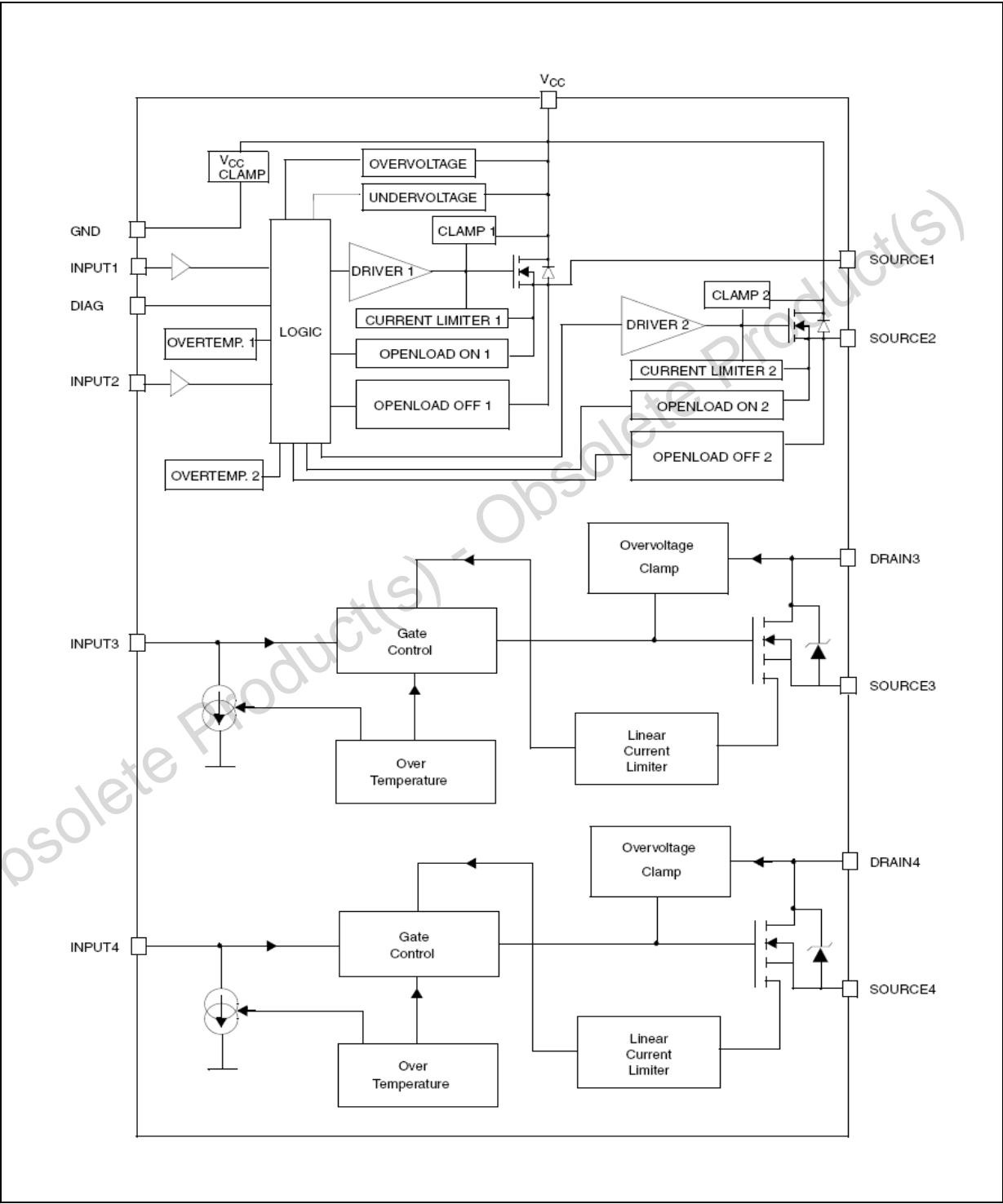
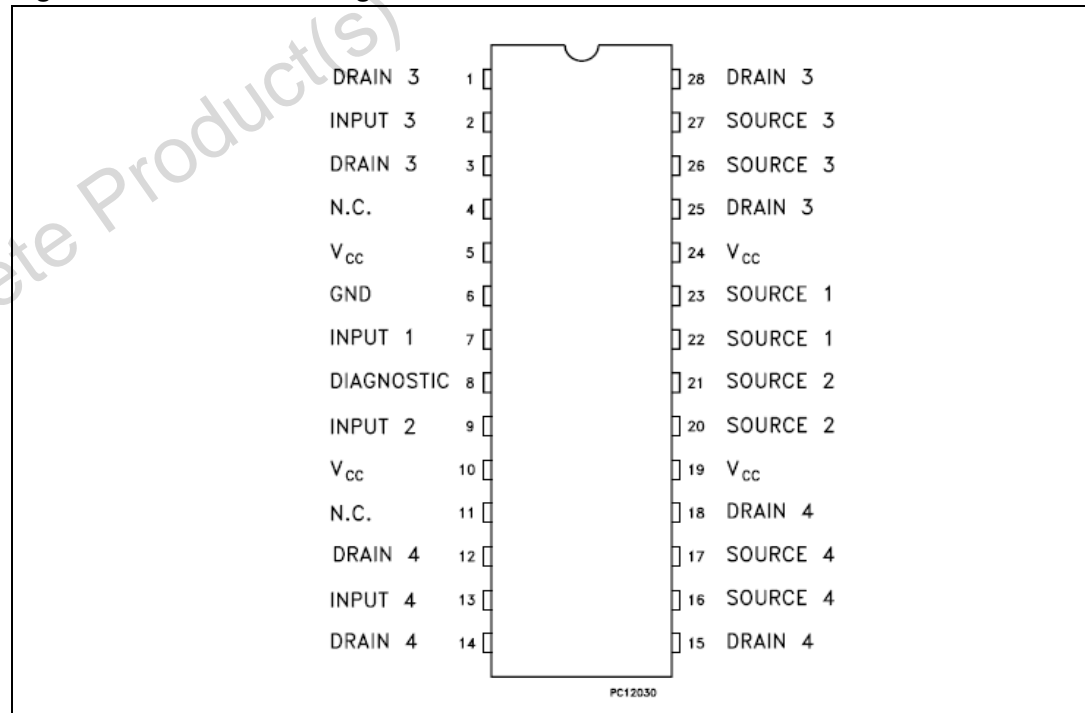

Table 2. Pin definition and function

No	Name	Function
1, 3, 25, 28	DRAIN 3	Drain of switch 3 (low-side switch)
2	INPUT 3	Input of switch 3 (low-side switch)
4, 11	N.C.	Not connected
5, 10, 19, 24	V _{CC}	Drain of switches 1 and 2 (high-side switches) and power supply voltage
6	GND	Ground of switches 1 and 2 (high-side switches)
7	INPUT 1	Input of switch 1 (high-side switches)
8	DIAGNOSTIC	Diagnostic of switches 1 and 2 (high-side switches)
9	INPUT 2	Input of switch 2 (high-side switch)
12, 14, 15, 18	DRAIN 4	Drain of switch 4 (low-side switch)
13	INPUT 4	Input of switch 4 (low-side switch)
16, 17	SOURCE 4	Source of switch 4 (low-side switch)
20, 21	SOURCE 2	Source of switch 2 (high-side switch)
22, 23	SOURCE 1	Source of switch 1 (high-side switch)
26, 27	SOURCE 3	Source of switch 3 (low-side switch)

Figure 2. Connection diagram

2 Electrical specifications

2.1 Thermal data

Table 3. Thermal data

Symbol	Parameter	Value Max (°C/W)
$R_{thj-case}$	Thermal resistance junction-case (high side switch)	20
$R_{thj-case}$	Thermal resistance junction-case (low side switch)	20
$R_{thj-amb}$	Thermal resistance junction-ambient (with 6 cm ² of Cu heat sink)	See Figure 49

2.2 Absolute maximum ratings

Table 4. Dual high side switch

Symbol	Parameter	Value	Unit
V_{CC}	DC supply voltage	41	V
$-V_{CC}$	Reverse DC supply voltage	-0.3	V
$-I_{GND}$	DC reverse ground pin current	-200	mA
I_{OUT}	DC output current	Internally limited	A
$-I_{OUT}$	Reverse DC output current	-6	A
I_{IN}	DC input current	±10	mA
I_{STAT}	DC status current	±10	mA
V_{ESD}	Electrostatic discharge (human body model: R = 1.5KΩ; C = 100pF)		
	– Input	4000	V
	– Status	4000	V
	– Output	5000	V
	– V _{CC}	5000	V
P_{tot}	Power dissipation (T _c = 25°C)	6	W
T_j	Junction operating temperature	Internally limited	°C
T_c	Case operating temperature	-40 to 150	°C
T_{stg}	Storage temperature	-55 to 150	°C

Table 5. Low side switch

Symbol	Parameter	Value	Unit
V_{DS}	Drain source voltage (V _{IN} = 0V)	Internally clamped	V
V_{IN}	Input voltage	Internally clamped	V
I_{IN}	Input current	±20	mA

Table 5. Low side switch (continued)

Symbol	Parameter	Value	Unit
$R_{IN\ MIN}$	Minimum input series impedance	150	Ω
I_D	Drain current	Internally limited	A
I_R	Reverse DC output current	-10.5	A
V_{ESD1}	Electrostatic discharge ($R = 1.5K\Omega$, $C = 100pF$)	4000	V
V_{ESD2}	Electrostatic discharge on output pin only (human body model: $R = 330\Omega$, $C = 150pF$)	5000	V
P_{tot}	Power dissipation ($T_c = 25^\circ C$)	6	W
T_j	Operating junction temperature	Internally limited	$^\circ C$
T_c	Case operating temperature	Internally limited	$^\circ C$
T_{stg}	Storage temperature	-55 to 150	$^\circ C$

2.3 Electrical characteristics for dual high side switch

$8V < V_{CC} < 36V$; $-40^\circ C < T_j < 150^\circ C$, unless otherwise specified.

Table 6. Power outputs (per each channel)

Symbol	Parameter	Test conditions	Min	Typ	Max	Unit
$V_{CC}^{(1)}$	Operating supply voltage		5.5	13	36	V
$V_{USD}^{(1)}$	Undervoltage shutdown		3	4	5.5	V
$V_{OV}^{(1)}$	Overvoltage shutdown		36	-	-	V
R_{ON}	On-state resistance	$I_{OUT} = 1A$; $T_j = 25^\circ C$ $I_{OUT} = 1A$; $V_{CC} > 8V$	-	-	160 320	$m\Omega$ $m\Omega$
$I_S^{(1)}$	Supply current	Off-state; $V_{CC} = 13V$; $V_{IN} = V_{OUT} = 0V$ Off-state; $V_{CC} = 13V$; $V_{IN} = V_{OUT} = 0V$; $T_j = 25^\circ C$ On-state; $V_{CC} = 13V$; $V_{IN} = 5V$; $I_{OUT} = 0V$	-	12 12 5	40 25 7	μA μA mA
$I_{L(off1)}$	Off-state output current	$V_{IN} = V_{OUT} = 0V$	0	-	50	μA
$I_{L(off2)}$	Off-state output current	$V_{IN} = 0V$; $V_{OUT} = 3.5V$	-75	-	0	μA
$I_{L(off3)}$	Off-state output current	$V_{IN} = V_{OUT} = 0V$; $V_{CC} = 13V$; $T_j = 125^\circ C$	-	-	5	μA
$I_{L(off4)}$	Off-state output current	$V_{IN} = V_{OUT} = 0V$; $V_{CC} = 13V$; $T_j = 25^\circ C$	-	-	3	μA

1. Per device.

Table 7. Switching (per each channel) ($V_{CC}=13V$)

Symbol	Parameter	Test conditions	Min	Typ	Max	Unit
$t_{d(on)}$	Turn-on delay time	$R_L = 13\Omega$ from V_{IN} rising edge to $V_{OUT} = 1.3V$	-	30	-	μs
$t_{d(off)}$	Turn-off delay time	$R_L = 13\Omega$ from V_{IN} falling edge to $V_{OUT} = 11.7V$	-	30	-	μs
$dV_{OUT}/dt_{(on)}$	Turn-on voltage slope	$R_L = 13\Omega$ from $V_{OUT} = 1.3V$ to $V_{OUT} = 10.4V$	-	(1)	-	$V/\mu s$
$dV_{OUT}/dt_{(off)}$	Turn-off voltage slope	$R_L = 13\Omega$ from $V_{OUT} = 11.7V$ to $V_{OUT} = 1.3V$	-	(1)	-	$V/\mu s$

1. See relative diagram

Table 8. Logic input (per each channel)

Symbol	Parameter	Test conditions	Min	Typ	Max	Unit
V_{IL}	Input low level		-	-	1.25	V
I_{IL}	Low level input current	$V_{IN} = 1.25V$	1	-	-	μA
V_{IH}	Input high level		3.25	-	-	V
I_{IH}	High level input current	$V_{IN} = 3.25V$	-	-	10	μA
$V_{I(hyst)}$	Input hysteresis voltage		0.5	-	-	V
V_{ICL}	Input clamp voltage	$I_{IN} = 1mA$ $I_{IN} = -1mA$	6	6.8 -0.7	8	V V

Table 9. Status pin (per each channel)

Symbol	Parameter	Test conditions	Min	Typ	Max	Unit
V_{STAT}	Status low output voltage	$I_{STAT} = 1.6 mA$	-	-	0.5	V
I_{LSTAT}	Status leakage current	Normal operation; $V_{STAT} = 5V$	-	-	10	μA
C_{STAT}	Status pin input capacitance	Normal operation; $V_{STAT} = 5V$	-	-	100	pF
V_{SCL}	Status clamp voltage	$I_{STAT} = 1mA$ $I_{STAT} = -1mA$	6	6.8 -0.7	8	V V

Table 10. Protections (per each channel)

Symbol	Parameter	Test conditions	Min	Typ	Max	Unit
T_{TSD}	Shutdown temperature		150	175	200	$^{\circ}C$
T_R	Reset temperature		135	-	-	$^{\circ}C$

Table 10. Protections (per each channel) (continued)

Symbol	Parameter	Test conditions	Min	Typ	Max	Unit
T_{hyst}	Thermal hysteresis		7	15	-	°C
t_{SDL}	Status delay in overload conditions	$T_j > T_{\text{TSD}}$	-	-	20	µs
I_{lim}	Current limitation	$T_j = 125^\circ\text{C}$ $5.5\text{V} < V_{\text{CC}} < 36\text{V}$	7 8	10	13 13 13	A A A
V_{demag}	Turn-off output clamp voltage	$I_{\text{OUT}} = 1\text{A}; L = 6\text{mH}$	$V_{\text{CC}} - 41$	$V_{\text{CC}} - 48$	$V_{\text{CC}} - 55$	V

Note: To ensure long term reliability under heavy overload or short circuit conditions, protection and related diagnostic signals must be used together with a proper software strategy. If the device is subjected to abnormal conditions, this software must limit the duration and number of activation cycles.

Table 11. Openload detection (per each channel)

Symbol	Parameter	Test conditions	Min	Typ	Max	Unit
I_{OL}	Openload on-state detection threshold	$V_{\text{IN}} = 5\text{V}$	20	40	80	mA
$t_{\text{DOL(on)}}$	Openload on-state detection delay	$I_{\text{OUT}} = 0\text{A}$	-	-	200	µs
V_{OL}	Openload off-state voltage detection threshold	$V_{\text{IN}} = 0\text{V}$	1.5	2.5	3.5	V
$t_{\text{DOL(off)}}$	Openload detection delay at turn-off		-	-	1000	µs

2.4 Electrical characteristics for low side switches

$-40^\circ\text{C} < T_j < 150^\circ\text{C}$, unless otherwise specified.

Table 12. Off-state

Symbol	Parameter	Test conditions	Min	Typ	Max	Unit
V_{CLAMP}	Drain source clamp voltage	$V_{\text{IN}} = 0\text{V}; I_{\text{D}} = 3.5\text{A}$	40	45	55	V
V_{CLTH}	Drain source clamp threshold voltage	$V_{\text{IN}} = 0\text{V}; I_{\text{D}} = 2\text{mA}$	36	-	-	V
V_{INTH}	Input threshold voltage	$V_{\text{DS}} = V_{\text{IN}}; I_{\text{D}} = 1\text{mA}$	0.5	-	2.5	V
I_{ISS}	Supply current from input pin	$V_{\text{DS}} = 0\text{V}; V_{\text{IN}} = 5\text{V}$	-	100	150	µA

Table 12. Off-state (continued)

Symbol	Parameter	Test conditions	Min	Typ	Max	Unit
V_{INCL}	Input-source clamp voltage	$I_{IN} = 1\text{mA}$ $I_{IN} = -1\text{mA}$	6 -1.0	6.8	8 -0.3	V
I_{DSS}	Zero input voltage drain current ($V_{IN} = 0\text{V}$)	$V_{DS} = 13\text{V}; V_{IN} = 0\text{V}; T_j = 25^\circ\text{C}$ $V_{DS} = 25\text{V}; V_{IN} = 0\text{V}$	-	-	30 75	μA

Table 13. On-state

Symbol	Parameter	Test conditions	Min	Typ	Max	Unit
$R_{DS(on)}$	Static drain source on resistance	$V_{IN} = 5\text{V}; I_D = 3.5\text{A}; T_j = 25^\circ\text{C}$ $V_{IN} = 5\text{V}; I_D = 3.5\text{A}$	-	-	60 120	$\text{m}\Omega$

$T_j = 25^\circ\text{C}$, unless otherwise specified.

Table 14. Dynamic

Symbol	Parameter	Test conditions	Min	Typ	Max	Unit
$g_{fs}^{(1)}$	Forward trans conductance	$V_{DD} = 13\text{V}; I_D = 3.5\text{A}$	-	9	-	S
C_{OSS}	Output capacitance	$V_{DS} = 13\text{V}; f = 1\text{MHz}; V_{IN} = 0\text{V}$	-	220	-	pF

1. Pulsed: Pulse duration = 300 μs , duty cycle 1.5%

Table 15. Switching

Symbol	Parameter	Test conditions	Min	Typ	Max	Unit
$t_{d(on)}$	Turn-on delay time	$V_{DD} = 15\text{V}; I_D = 3.5\text{A}$ $V_{gen} = 5\text{V}; R_{gen} = R_{IN\text{ MIN}} = 150\Omega$	-	100	300	ns
t_r	Rise time		-	470	1500	ns
$t_{d(off)}$	Turn-off delay time		-	500	1500	ns
t_f	Fall time		-	350	1000	ns
$t_{d(on)}$	Turn-on delay time	$V_{DD} = 15\text{V}; I_D = 3.5\text{A}$ $V_{gen} = 5\text{V}; R_{gen} = 2.2\text{K}\Omega$	-	0.75	2.3	μs
t_r	Rise time		-	4.6	14	μs
$t_{d(off)}$	Turn-off delay time		-	5.4	16	μs
t_f	Fall time		-	3.6	11	μs
$(di/dt)_{on}$	Turn-on current slope	$V_{DD} = 15\text{V}; I_D = 3.5\text{A}; V_{gen} = 5\text{V};$ $R_{gen} = R_{IN\text{ MIN}} = 150\Omega$	-	6.5	-	$\text{A}/\mu\text{s}$
Q_i	Total input charge	$V_{DD} = 12\text{V}; I_D = 3.5\text{A}; V_{IN} = 5\text{V}$ $I_{gen} = 2.13\text{mA}$	-	18	-	nC

Table 16. Source drain diode

Symbol	Parameter	Test conditions	Min	Typ	Max	Unit
$V_{SD}^{(1)}$	Forward on voltage	$I_{SD} = 3.5A; V_{IN} = 0V$	-	0.8	-	V
t_{rr}	Reverse recovery time	$I_{SD} = 3.5A; di/dt = 20A/\mu s$ $V_{DD} = 30V; L = 200\mu H$	-	220	-	ns
Q_{rr}	Reverse recovery charge		-	0.28	-	μC
I_{RRM}	Reverse recovery current		-	2.5	-	A

1. Pulsed: Pulse duration = 300 μs , duty cycle 1.5%

-40°C < T_j < 150°C, unless otherwise specified.

Table 17. Protections

Symbol	Parameter	Test conditions	Min	Typ	Max	Unit
I_{lim}	Drain current limit	$V_{IN} = 5V; V_{DS} = 13V$ $V_{IN} = 5V; V_{DS} = 13V; T_j = 125^\circ C$	6 6.5	9	12 12	A A
t_{dlim}	Step response current limit	$V_{IN} = 5V; V_{DS} = 13V$	-	4	-	μs
T_{jsh}	Over temperature shutdown		150	175	-	°C
T_{jrs}	Over temperature reset		135	-	-	°C
I_{gf}	Fault sink current	$V_{IN} = 5V; V_{DS} = 13V; T_j = T_{jsh}$	-	15	-	mA
E_{as}	Single pulse avalanche energy	Starting $T_j = 25^\circ C; V_{DD} = 24V$ $V_{IN} = 5V; R_{gen} = R_{IN MIN} = 150\Omega;$ $L = 24mH$	200	-	-	mJ

2.5 Dual high-side switch timing data

Figure 3. Switching time waveforms

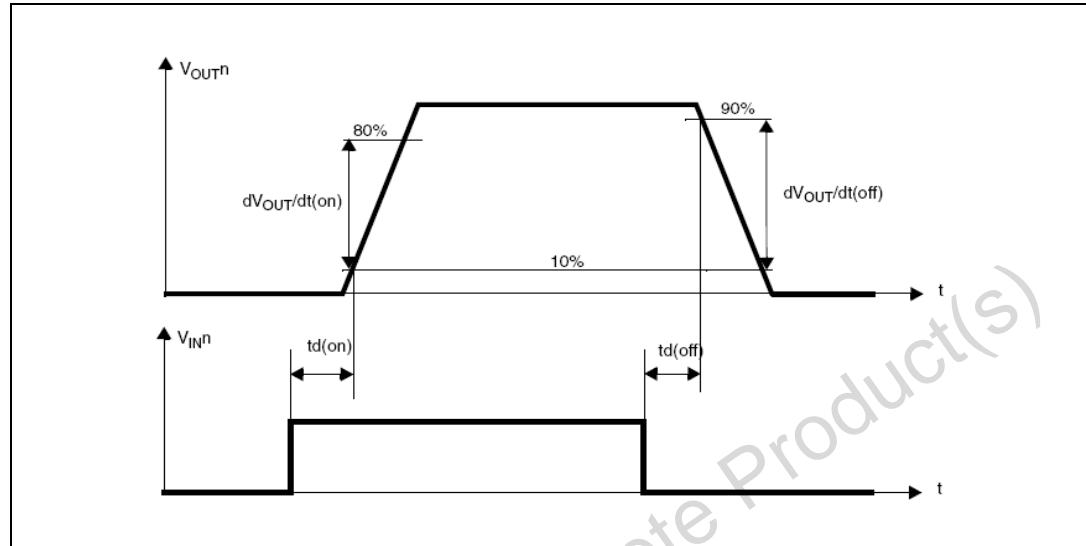

Table 18. Truth table

Conditions	Input	Output	Status
Normal operation	L	L	H
	H	H	H
Current limitation	L	L	H
	H	X	($T_j < T_{TSD}$) H ($T_j > T_{TSD}$) L
Over temperature	L	L	H
	H	L	L
Undervoltage	L	L	X
	H	L	X
Overvoltage	L	L	H
	H	L	H
Output voltage $> V_{OL}$	L	H	L
	H	H	H
Output current $< I_{OL}$	L	L	H
	H	H	L

Figure 4. Open-load status timing (with external pull-up)

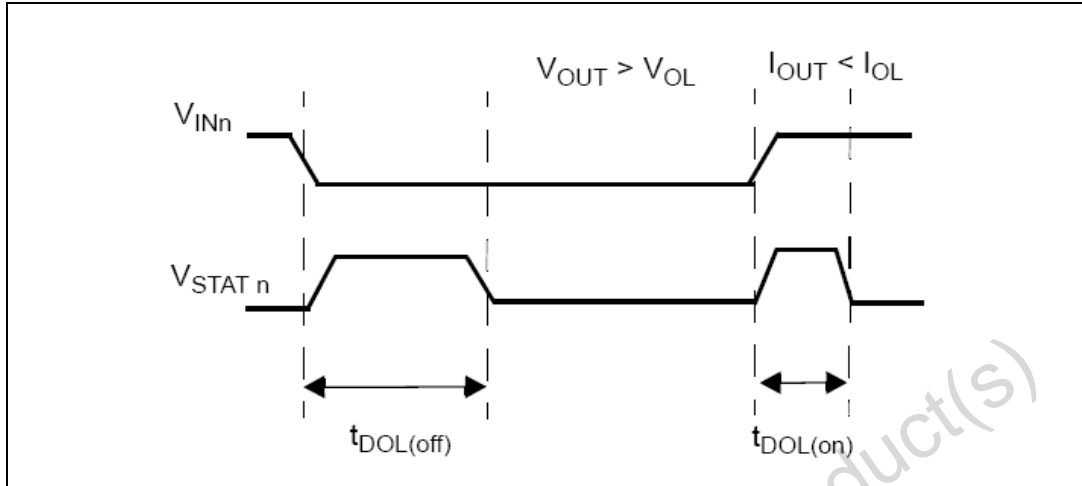
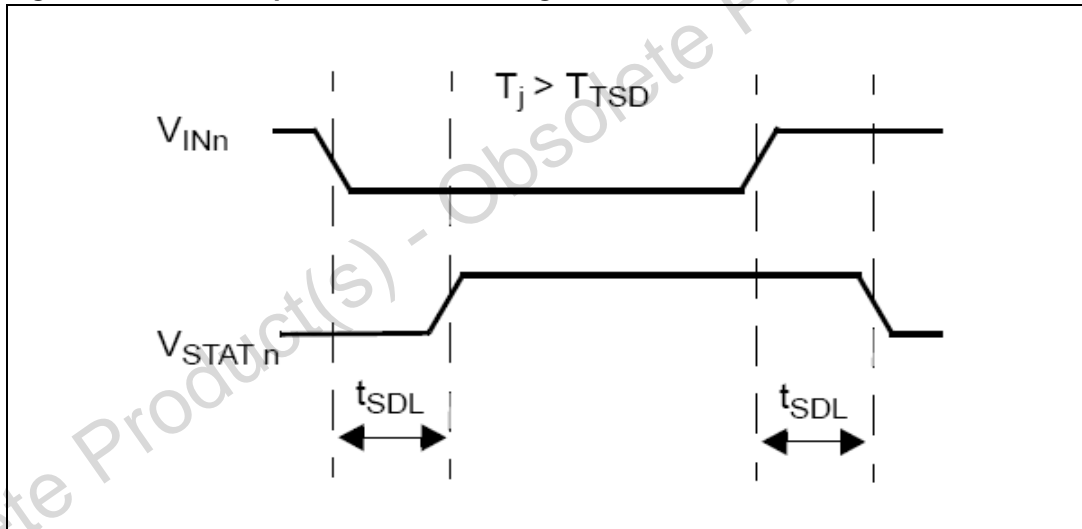

Figure 5. Over temperature status timing



2.6 Electrical characterization for dual high side switch

Figure 6. Off-state output current

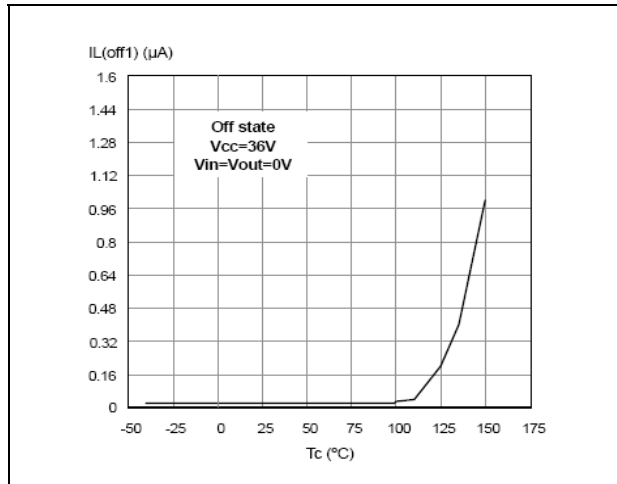

Figure 7. Input clamp voltage

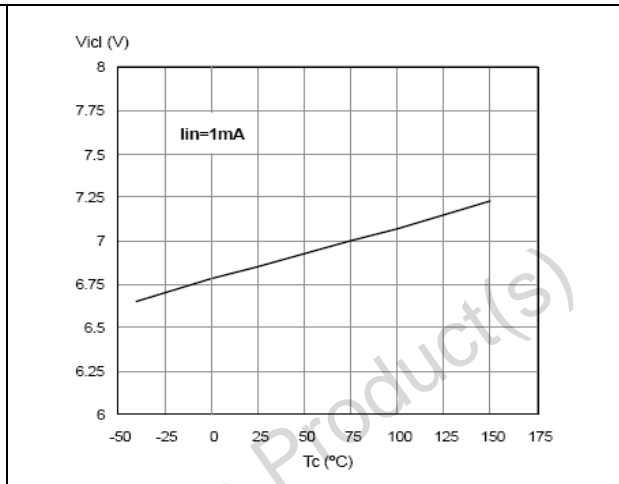

Figure 8. High level input current

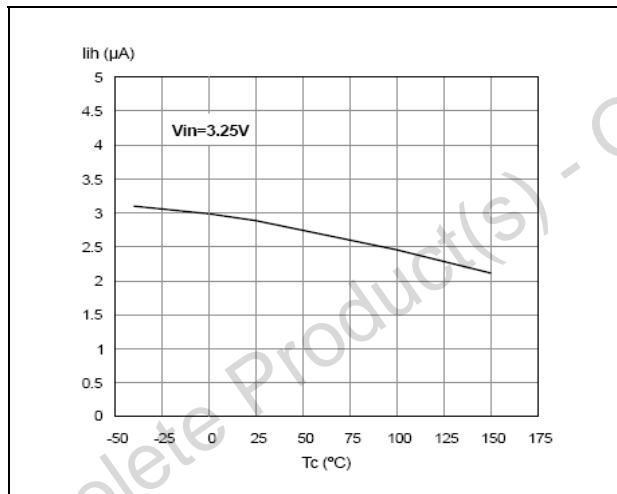

Figure 9. Input high level voltage

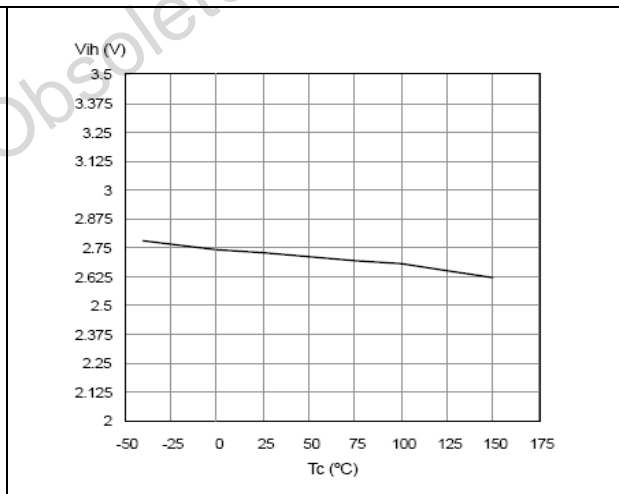

Figure 10. Input low level voltage

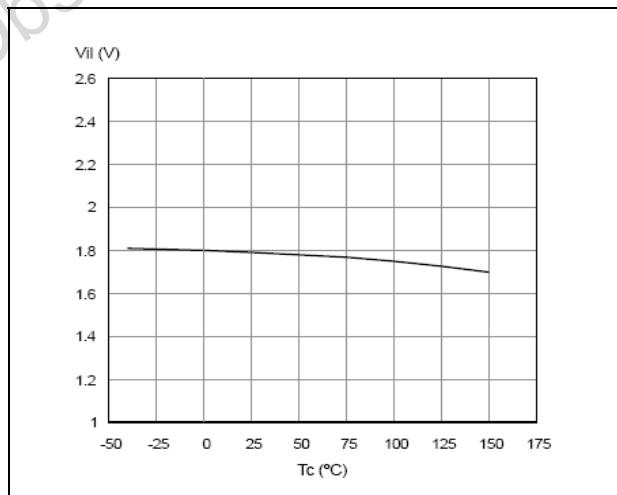

Figure 11. Input hysteresis voltage

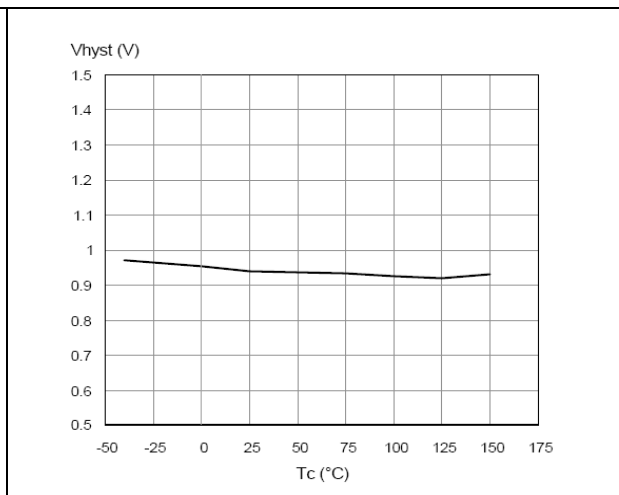

Figure 12. Overvoltage shutdown

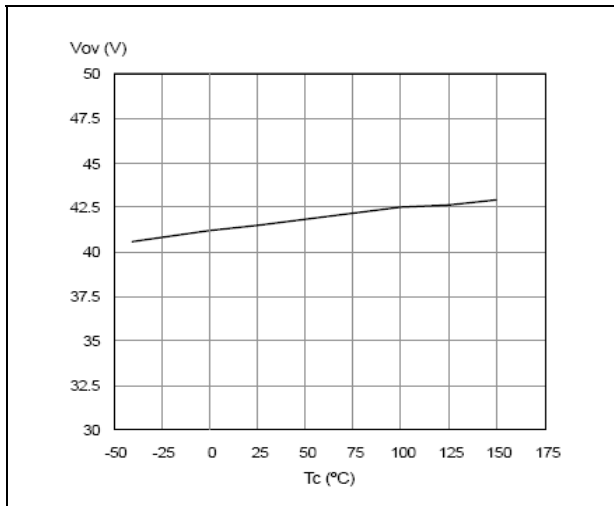

Figure 13. I_{LIM} vs T_{case}

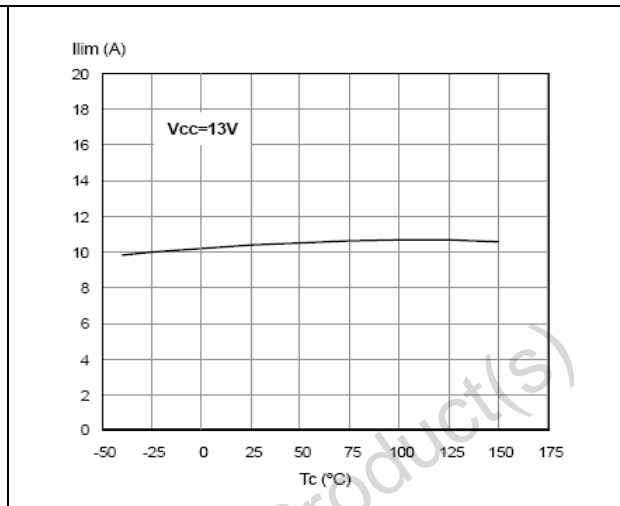

Figure 14. Turn-on voltage slope

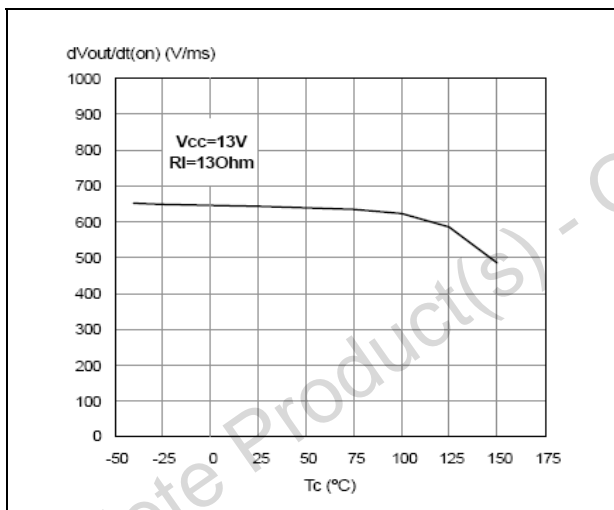

Figure 15. Turn-off voltage slope

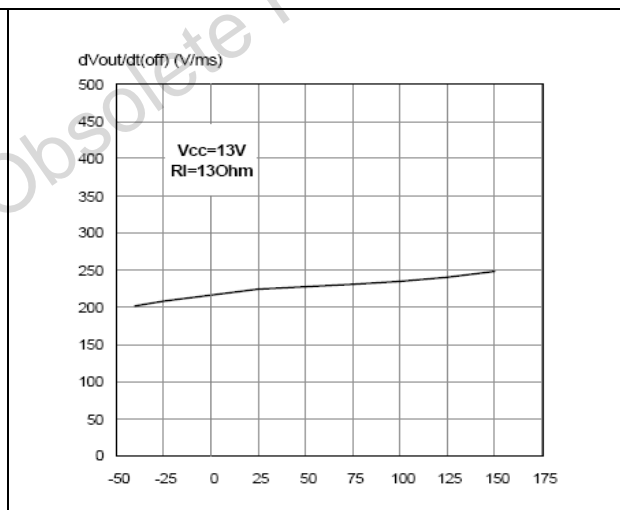

Figure 16. On-state resistance vs T_{case}

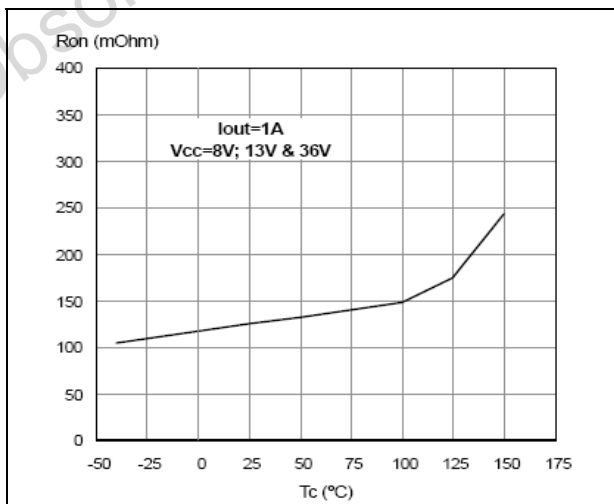

Figure 17. On-state resistance vs V_{CC}

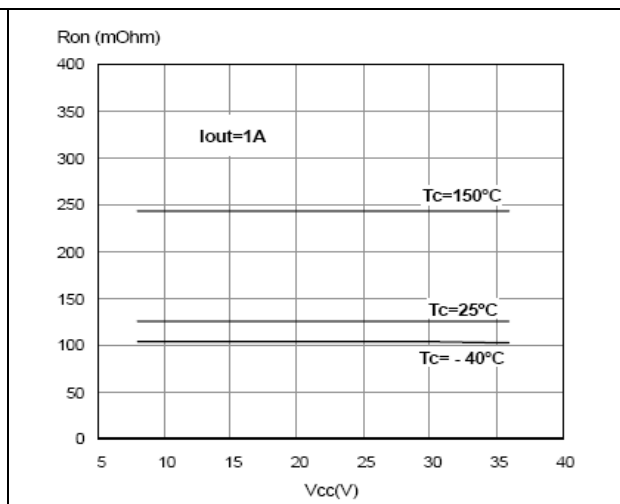

Figure 18. Status leakage current

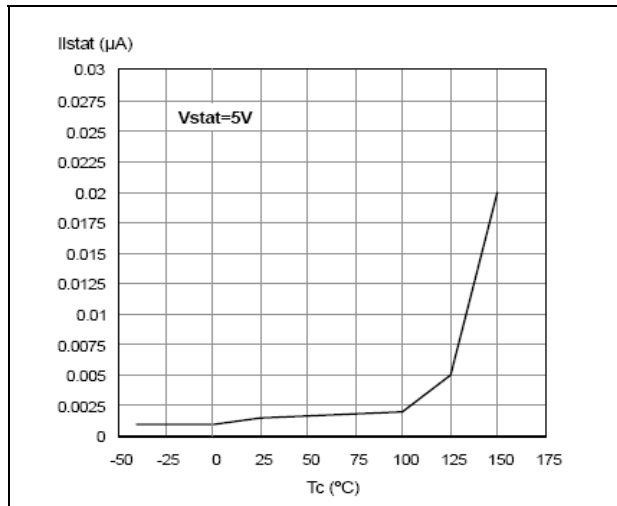

Figure 19. Status low output voltage

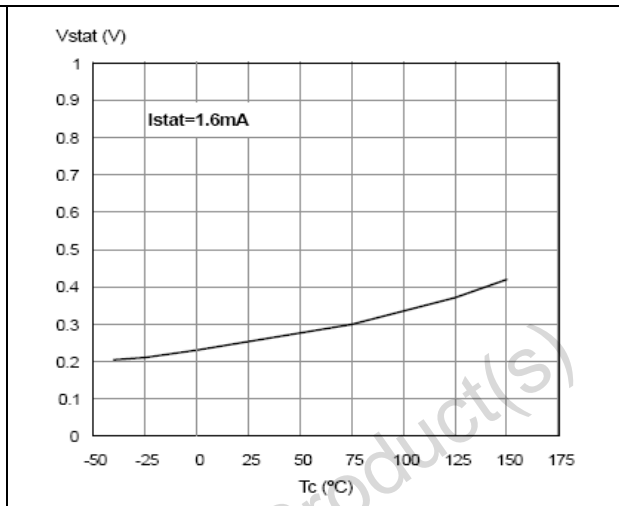

Figure 20. Openload on-state detection threshold

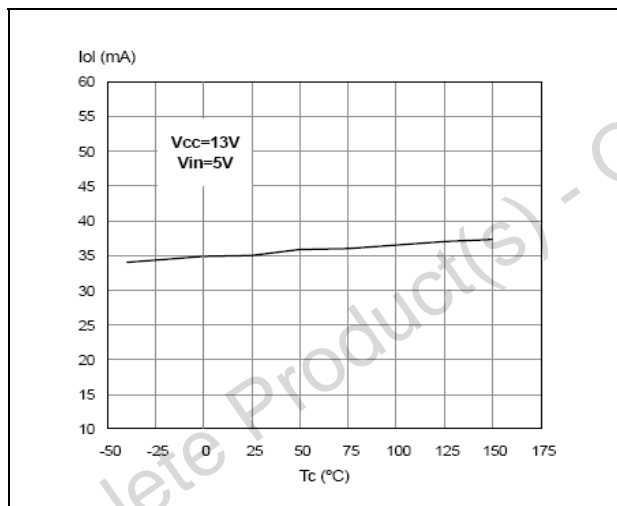

Figure 21. Openload off-state voltage detection threshold

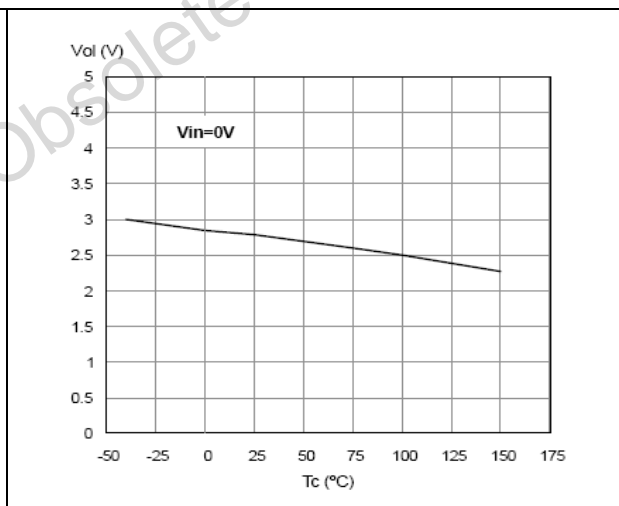
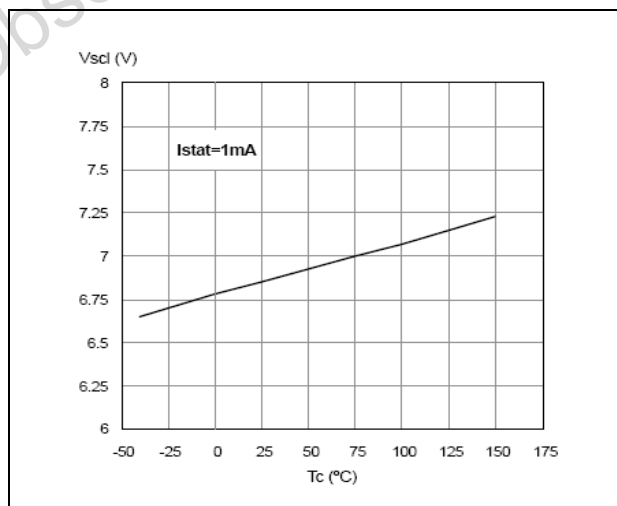

Figure 22. Status clamp voltage



2.7 Electrical characterization for low side switches

Figure 23. Static drain source on resistance

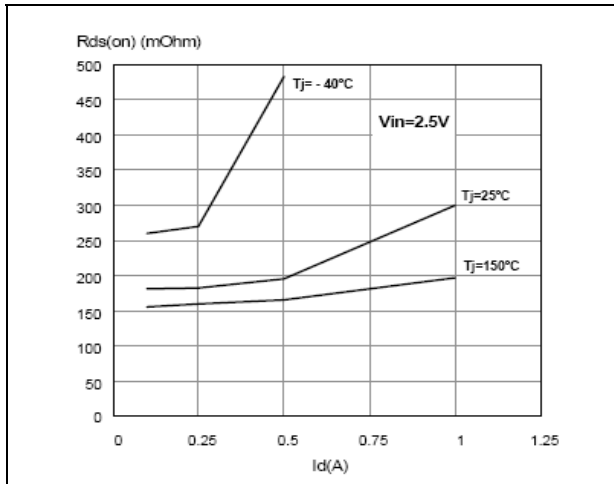

Figure 24. Derating curve

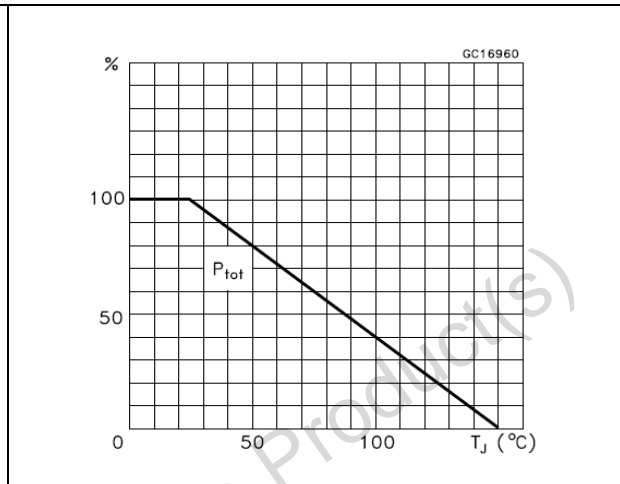

Figure 25. Transconductance

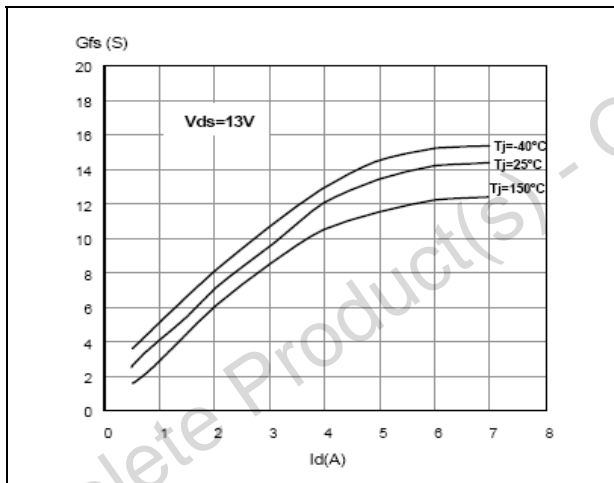

Figure 26. Transfer characteristics

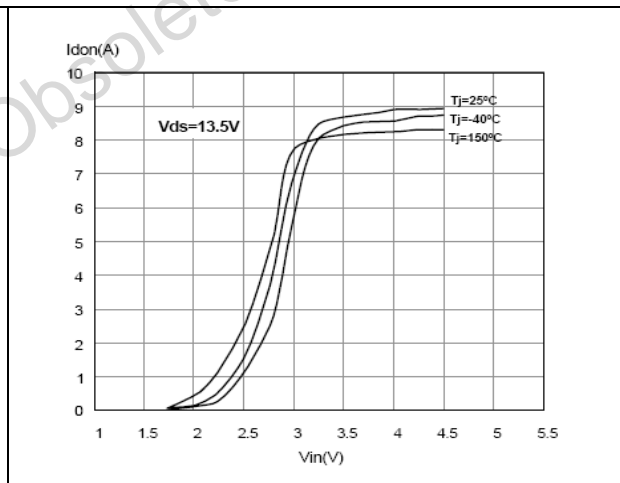

Figure 27. Turn-on current slope ($V_{in}=5V$)

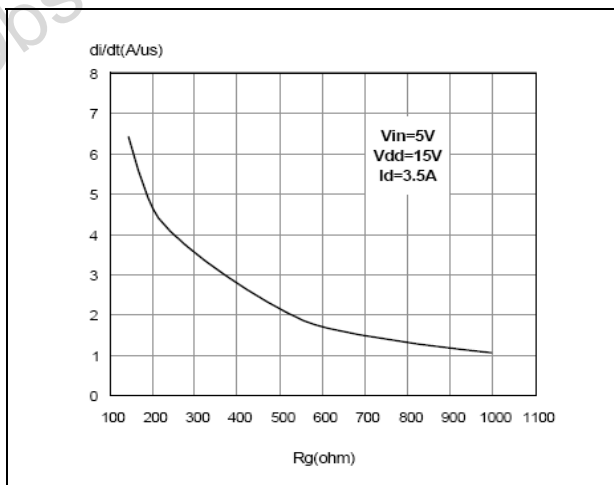

Figure 28. Turn-on current slope ($V_{in}=3.5V$)

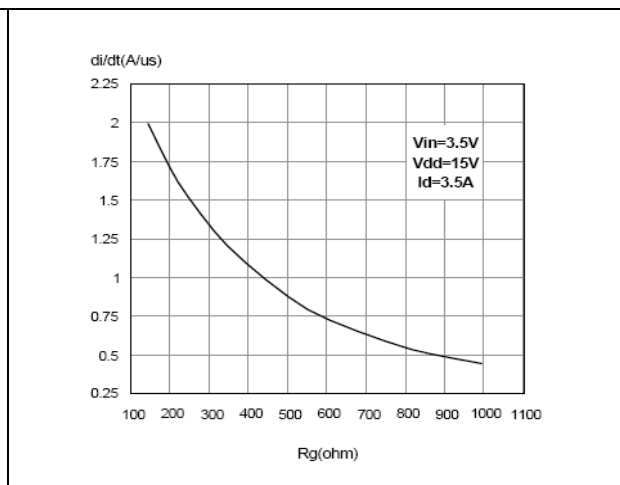

Figure 29. Input voltage vs input charge

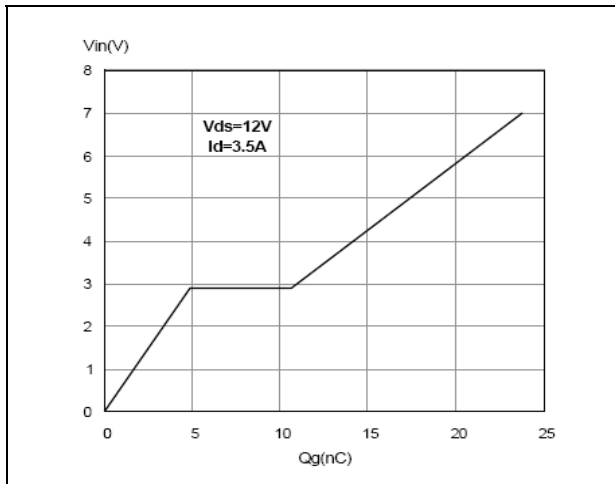

Figure 31. Switching time resistive load (Vin=5V)

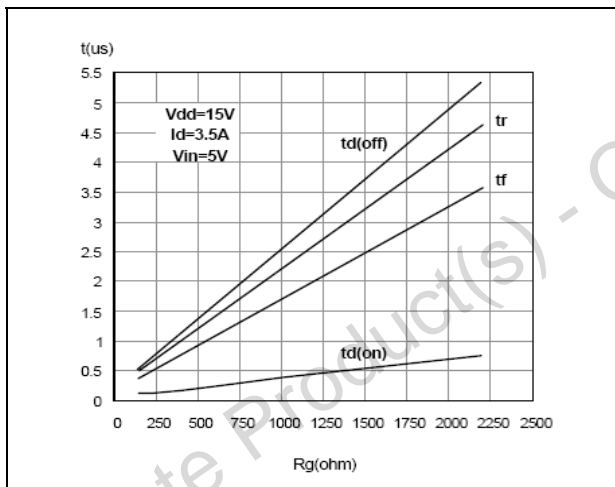

Figure 33. Output characteristics

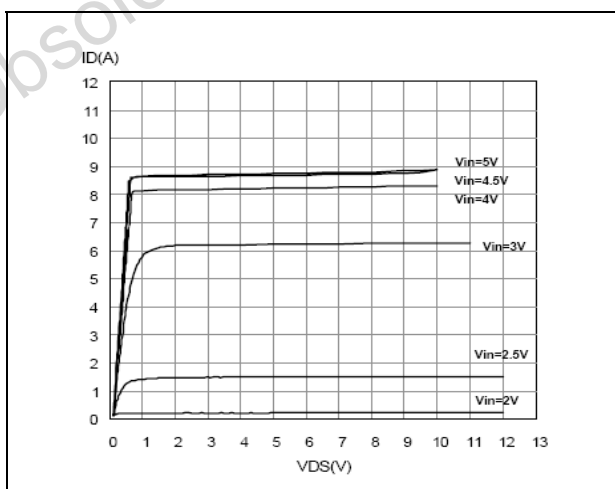

Figure 30. Capacitance variations

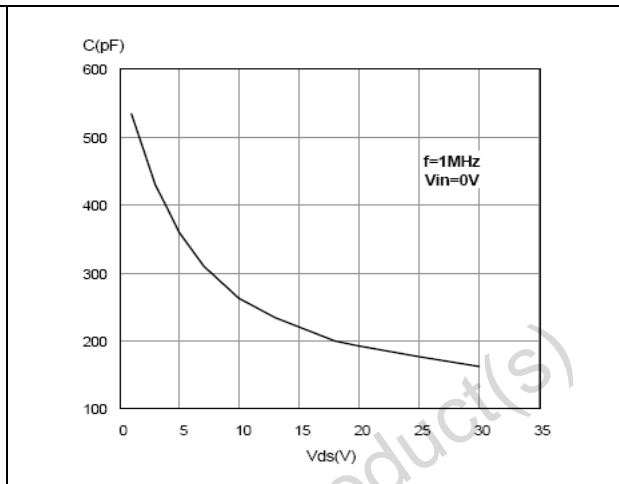

Figure 32. Switching time resistive load (Rg=100ohm)

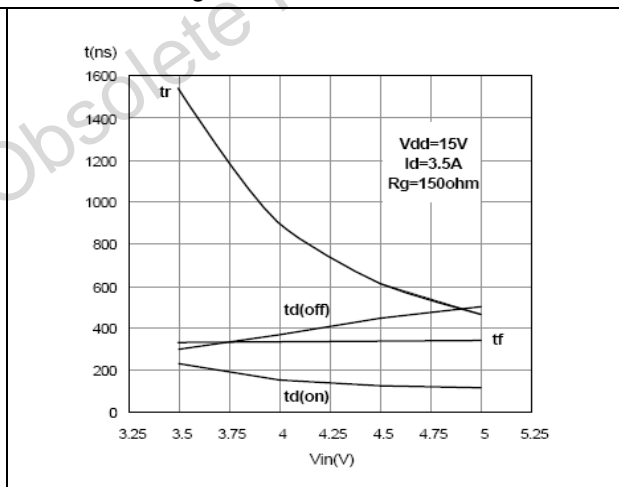

Figure 34. Step response current limit

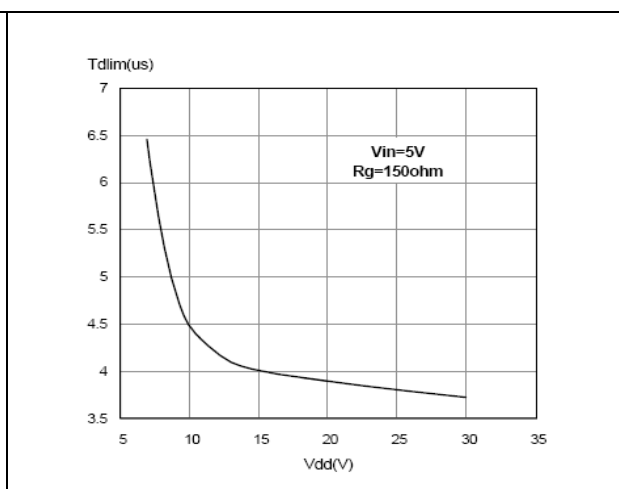

Figure 35. Source drain diode forward characteristics

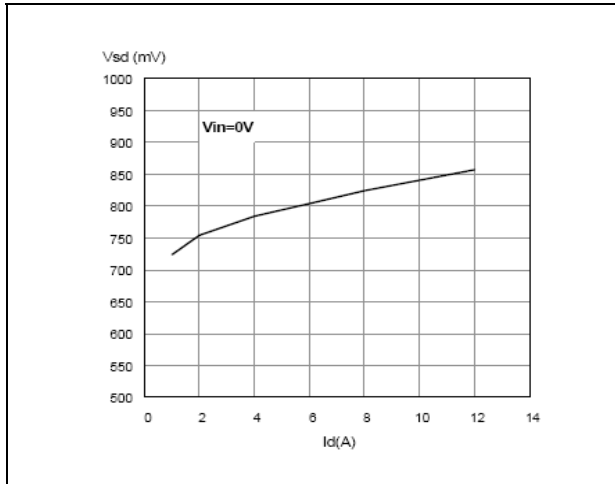

Figure 36. Static drain source on resistance vs I_d

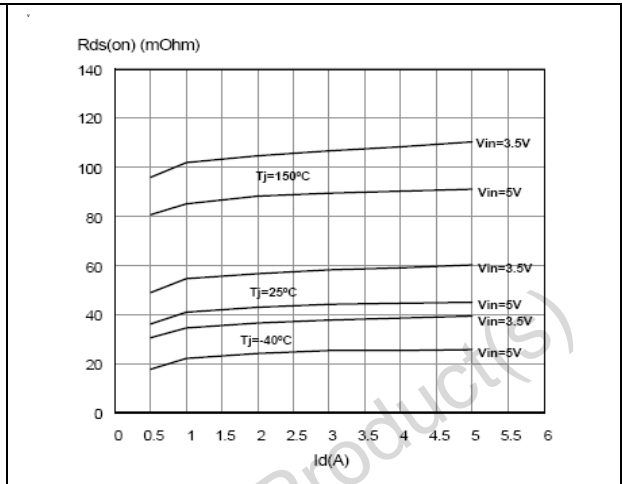

Figure 37. Static drain source on resistance vs input voltage ($I_d=7A$)

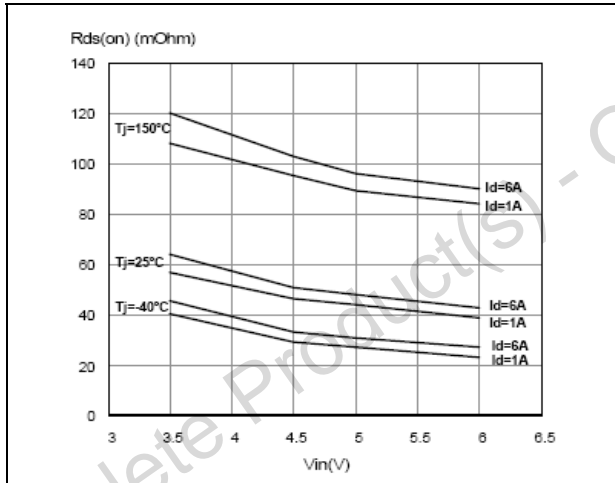

Figure 38. Static drain source on resistance vs input voltage

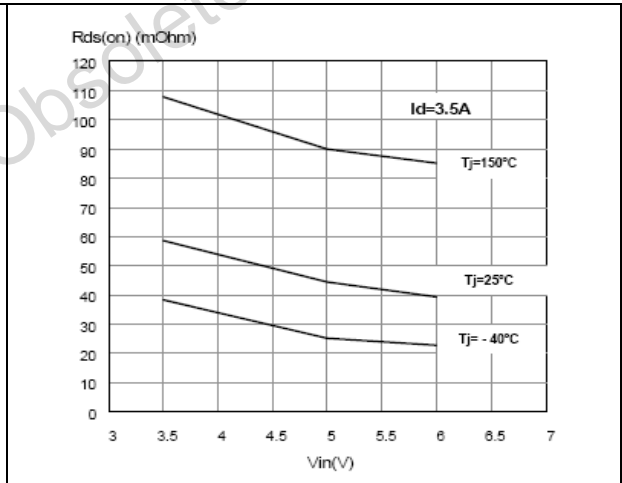

Figure 39. Normalized input threshold voltage vs temperature

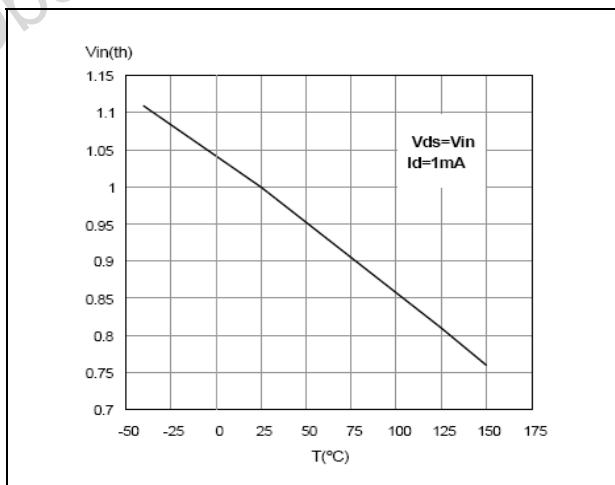

Figure 40. Normalized on resistance vs temperature

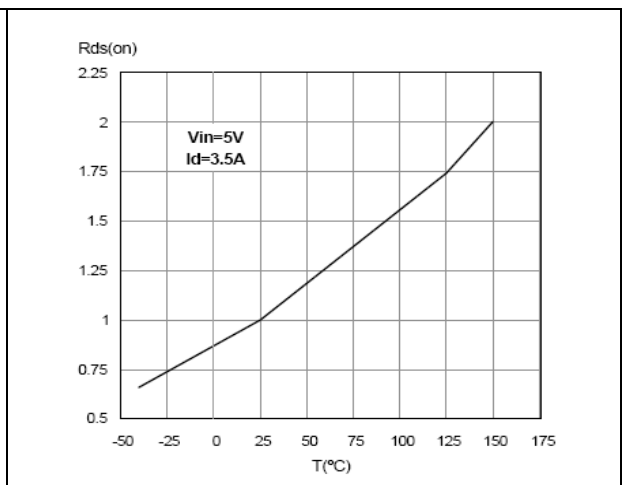

Figure 41. Turn-off drain source voltage slope ($V_{in}=3.5V$) **Figure 42. Turn-off drain source voltage slope ($V_{in}=5V$)**

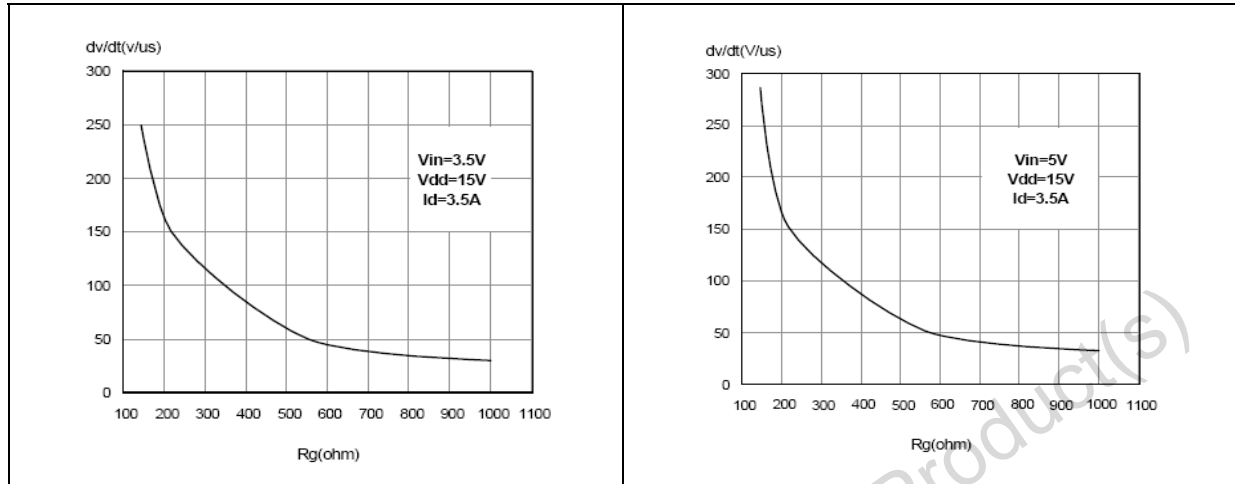
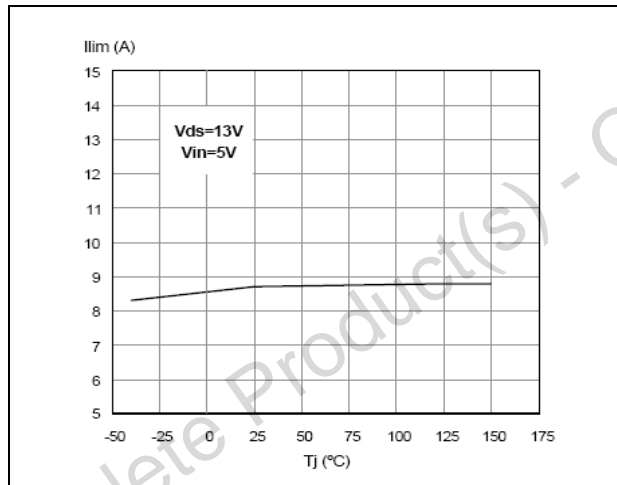
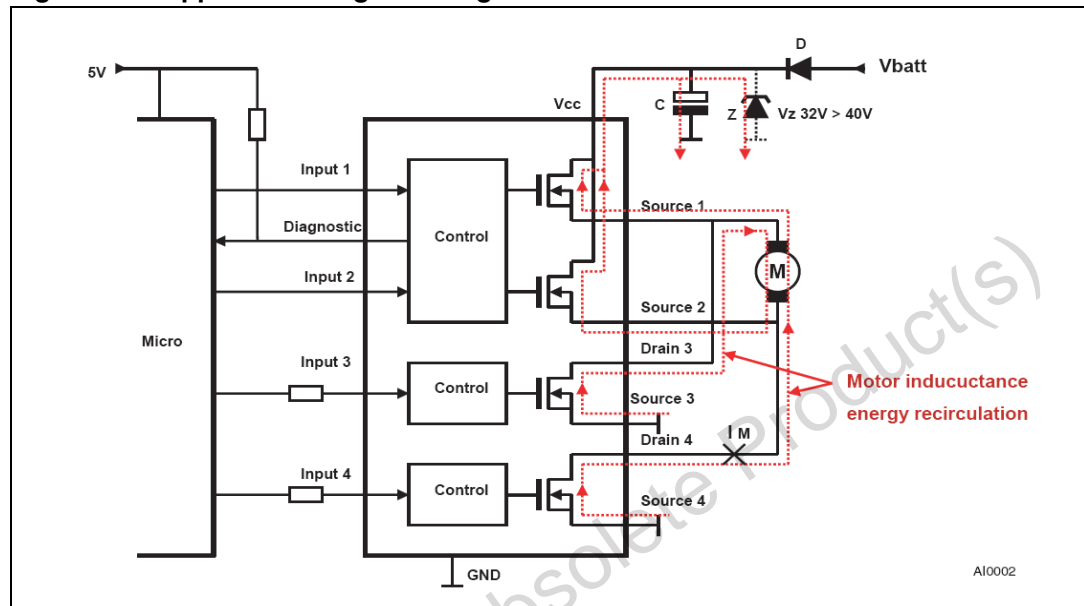

Figure 43. Current limit vs junction temperature



3 Application recommendations

Figure 44. Application diagram bridge drivers



Most motor bridge drivers use a reverse battery protection diode (D) inside the supply rail. This diode prevents a reverse current flow back to V_{BATT} in case the bridge becomes disabled via the logic inputs while motor inductance still carries energy. In order to prevent a hazardous overvoltage at circuit supply terminal (V_{CC}), a blocking capacitor (C) is needed to limit the voltage overshoot. As basic orientation, $50\mu\text{F}$ per 1A load current is recommended. As an alternative, a Zener protection (Z) is also suitable.

Even if a reverse polarity diode is not present, it is recommended to use a capacitor or Zener at V_{CC} because a similar problem appears in case the supply terminal of the module has intermittent electrical contact to the battery or gets disconnected while the motor is operating.

Figure 45. Recommended motor operation

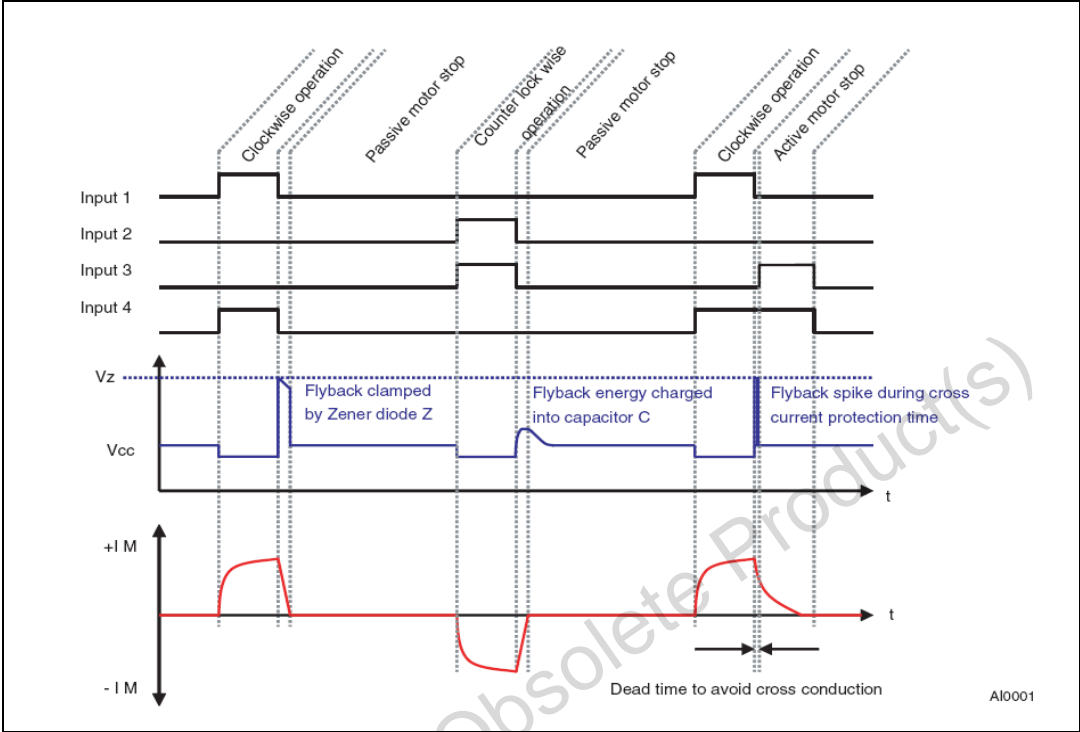
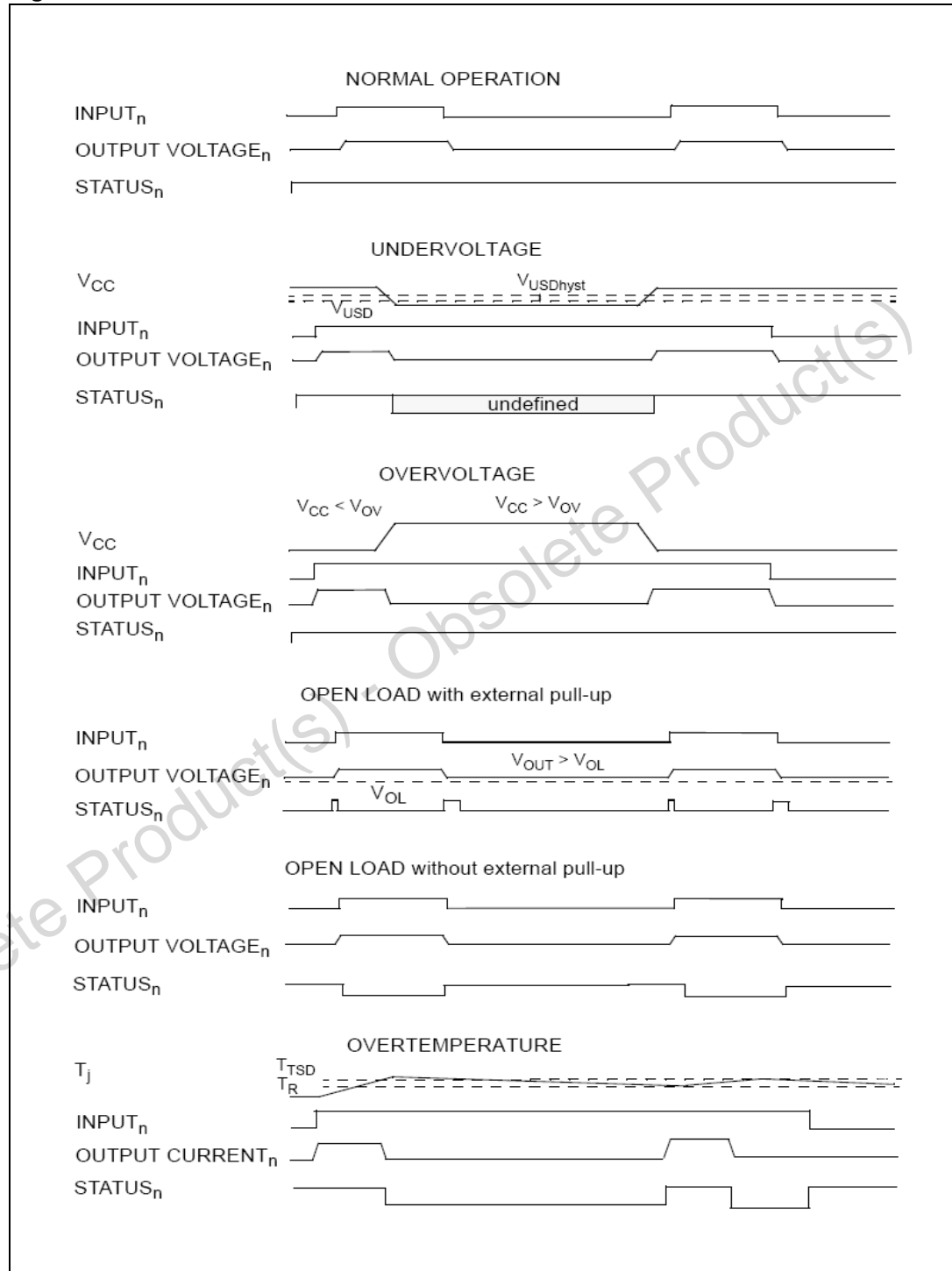

Figure 46. Waveforms



4 Thermal data

4.1 SO-28 thermal data

Figure 47. SO-28 PC board

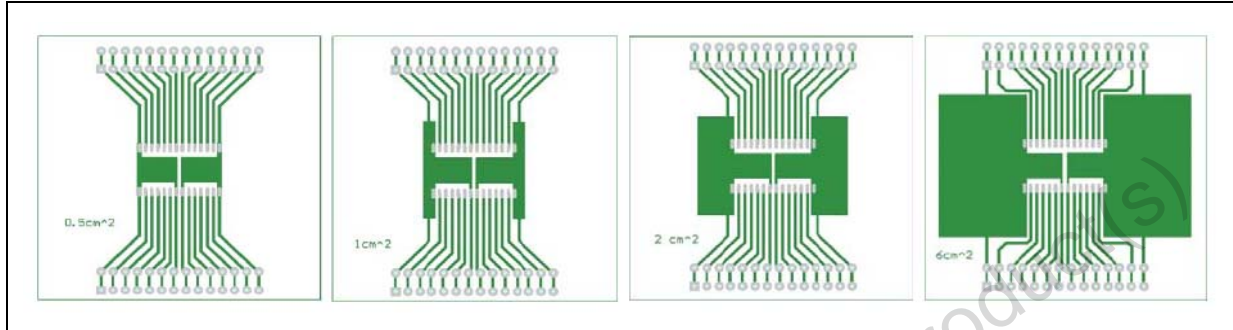

Note: Layout condition of R_{th} and Z_{th} measurements (PCB FR4 area = 58mm x 58mm, PCB thickness = 2mm, Cu thickness = 35 μ m, Copper areas: from minimum pad layout to 6cm²).

Figure 48. Chipset configuration

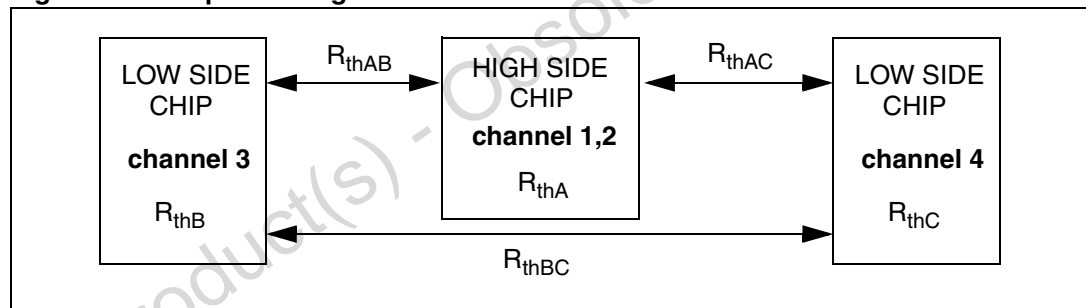
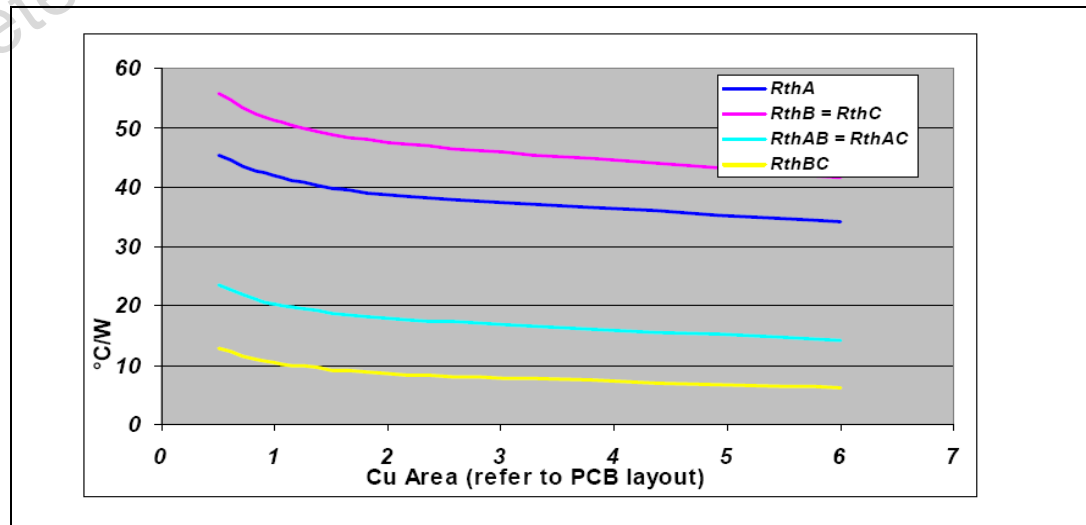

Figure 49. Auto and mutual $R_{thj-amb}$ vs PCB copper area in open box free air condition^(a)



a. see definitions in [Section 5.2 on page 31](#)

4.2 Thermal calculation in clockwise and anti-clockwise operation in steady state mode

Table 19. Thermal calculation in clockwise and anti-clockwise operation in steady state mode

HS ₁	HS ₂	LS ₃	LS ₄	T _{jHS12}	T _{jLS3}	T _{jLS4}
On	Off	Off	On	$\frac{P_{dHS1} \times R_{thHS} + P_{dLS4} \times R_{thHLSL} + T_{amb}}{R_{thHLSL} + T_{amb}}$	$\frac{P_{dHS1} \times R_{thHLSL} + P_{dLS4} \times R_{thLSL} + T_{amb}}{R_{thLSL} + T_{amb}}$	$\frac{P_{dHS1} \times R_{thHLSL} + P_{dLS4} \times R_{thLS} + T_{amb}}{R_{thLS} + T_{amb}}$
Off	On	On	Off	$\frac{P_{dHS2} \times R_{thHS} + P_{dLS3} \times R_{thHLSL} + T_{amb}}{R_{thHLSL} + T_{amb}}$	$\frac{P_{dHS2} \times R_{thHLSL} + P_{dLS3} \times R_{thLS} + T_{amb}}{R_{thLS} + T_{amb}}$	$\frac{P_{dHS2} \times R_{thHLSL} + P_{dLS3} \times R_{thLSL} + T_{amb}}{R_{thLSL} + T_{amb}}$

4.2.1 Thermal resistances definition

Values according to the PCB heatsink area.

$R_{thHS} = R_{thHS1} = R_{thHS2}$ = high side chip thermal resistance junction to ambient (HS₁ or HS₂ in on-state)

$R_{thLS} = R_{thLS3} = R_{thLS4}$ = low side chip thermal resistance junction to ambient

$R_{thHLSL} = R_{thHS1LS4} = R_{thHS2LS3}$ = mutual thermal resistance junction to ambient between high side and low side chips

$R_{thLSL} = R_{thLS3LS4}$ = mutual thermal resistance junction to ambient between low side chips

4.2.2 Thermal calculation in transient mode^(b)

$$T_{jHS12} = Z_{thHS} \times P_{dHS12} + Z_{thHLSL} \times (P_{dLS3} + P_{dLS4}) + T_{amb}$$

$$T_{jLS3} = Z_{thHLSL} \times P_{dHS12} + Z_{thLS} \times P_{dLS3} + Z_{thLSL} \times P_{dLS4} + T_{amb}$$

$$T_{jLS4} = Z_{thHLSL} \times P_{dHS12} + Z_{thLSL} \times P_{dLS3} + Z_{thLS} \times P_{dLS4} + T_{amb}$$

4.2.3 Single pulse thermal impedance definition

Values according to the PCB heatsink area.

Z_{thHS} = high side chip thermal impedance junction to ambient

$Z_{thLS} = Z_{thLS3} = Z_{thLS4}$ = low side chip thermal impedance junction to ambient

$Z_{thHLSL} = Z_{thHS12LS3} = Z_{thHS12LS4}$ = mutual thermal impedance junction to ambient between high side and low side chips

$Z_{thLSL} = Z_{thLS3LS4}$ = mutual thermal impedance junction to ambient between low side chips

4.2.4 Pulse calculation formula

$$Z_{TH\delta} = R_{TH} \cdot \delta + Z_{THtp} (1 - \delta)$$

where $\delta = t_p/T$

b. Calculation is valid in any dynamic operating condition. P_d values set by user.

Figure 50. SO-28 HSD thermal impedance junction ambient single pulse

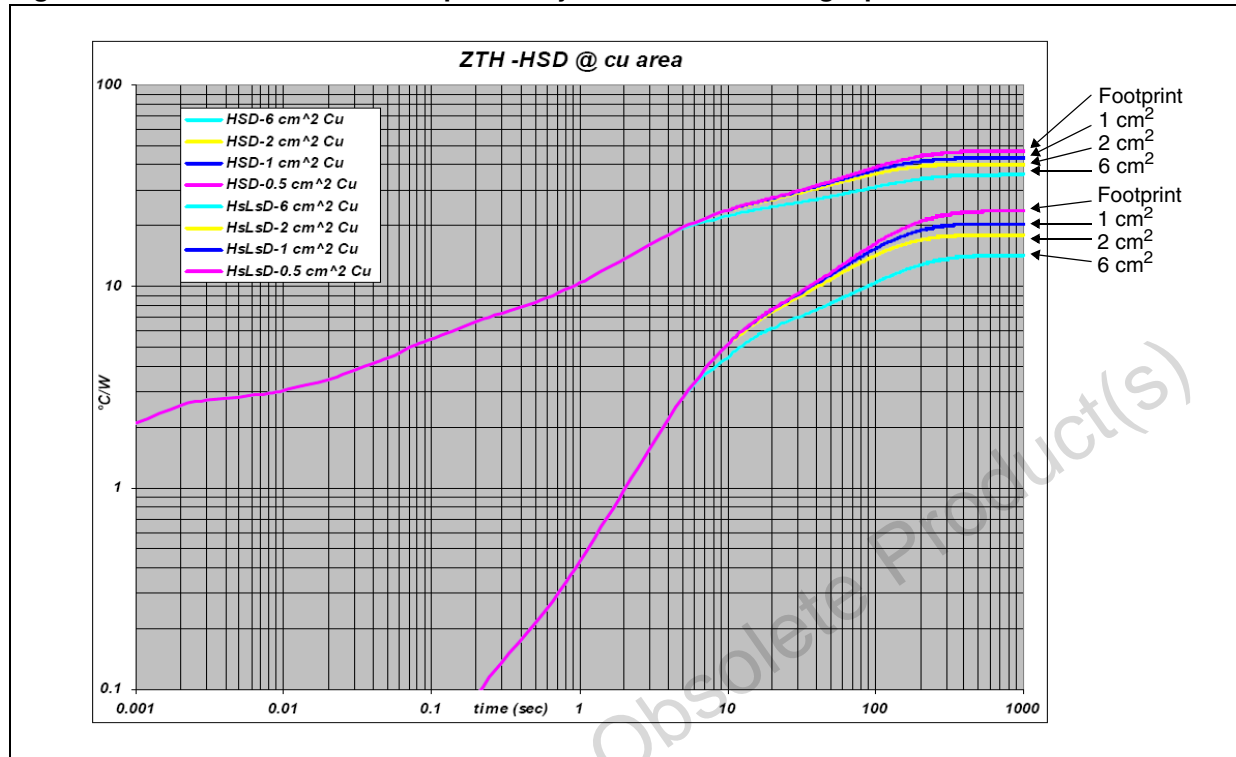

Figure 51. SO-28 LSD thermal impedance junction ambient single pulse

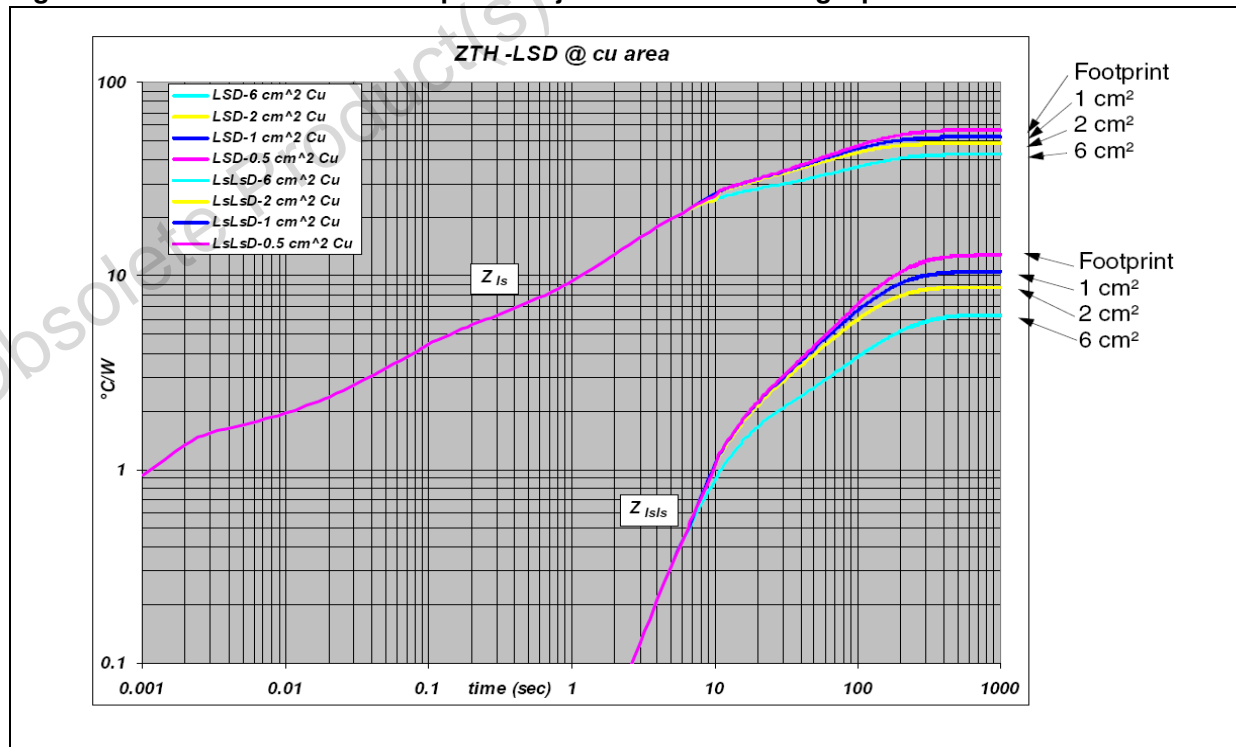

Figure 52. Thermal fitting model of an H-bridge in SO-28

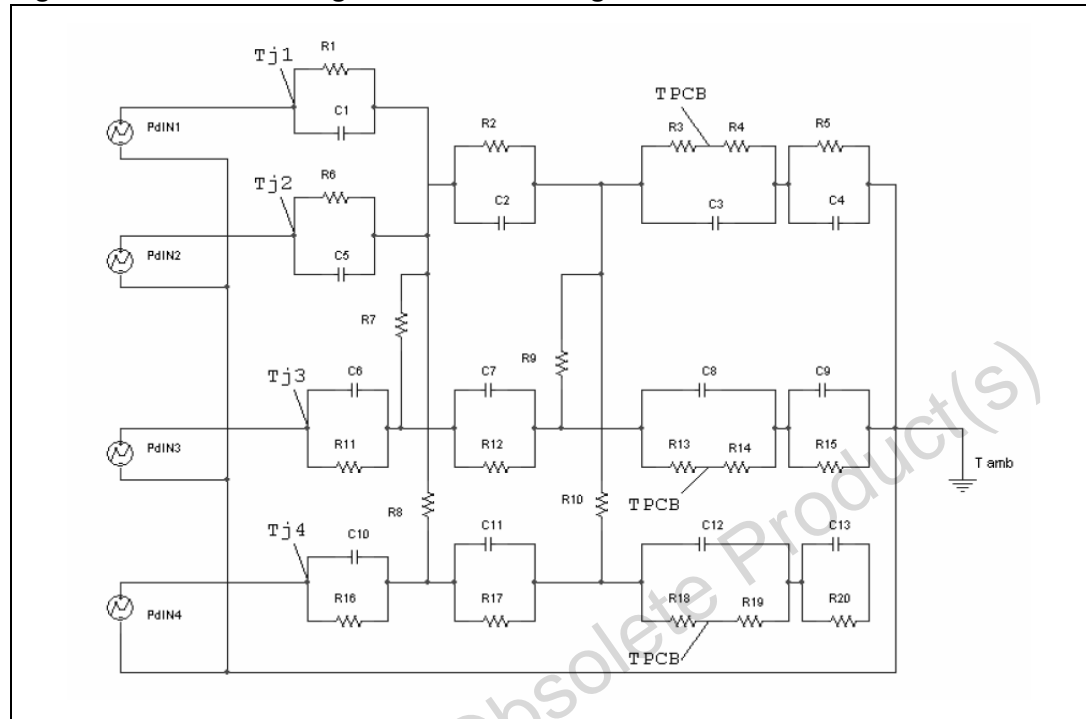

Table 20. Thermal parameters⁽¹⁾

Area/island (cm ²)	Footprint	1	2	6
R1 = R6 (°C/W)	2.6			
R2 (°C/W)	3.5			
R12 = R17 (°C/W)	3.5			
R3 = R13 = R18 (°C/W)	15.5			
R4 = R14 = R19 (°C/W)	10.5			
R5 = R15 = R20 (°C/W)	62.28	52.28	44.28	32.28
R7 = R8 = R9 = R10 (°C/W)	150			
R11 = R16 (°C/W)	1.5			
C1 = C5 (W.s/°C)	0.00025			
C2 = C7 = C11 (W.s/°C)	0.024			
C3 = C8 = C12 (W.s/°C)	0.2			
C4 = C9 = C13 (W.s/°C)	1.6	1.61	1.7	3.25
C6 = C10 (W.s/°C)	0.00075			

1. The blank space means that the value is the same as the previous one.

5 Package mechanical data

5.1 SO-28 mechanical data

Figure 53. SO-28 package outline

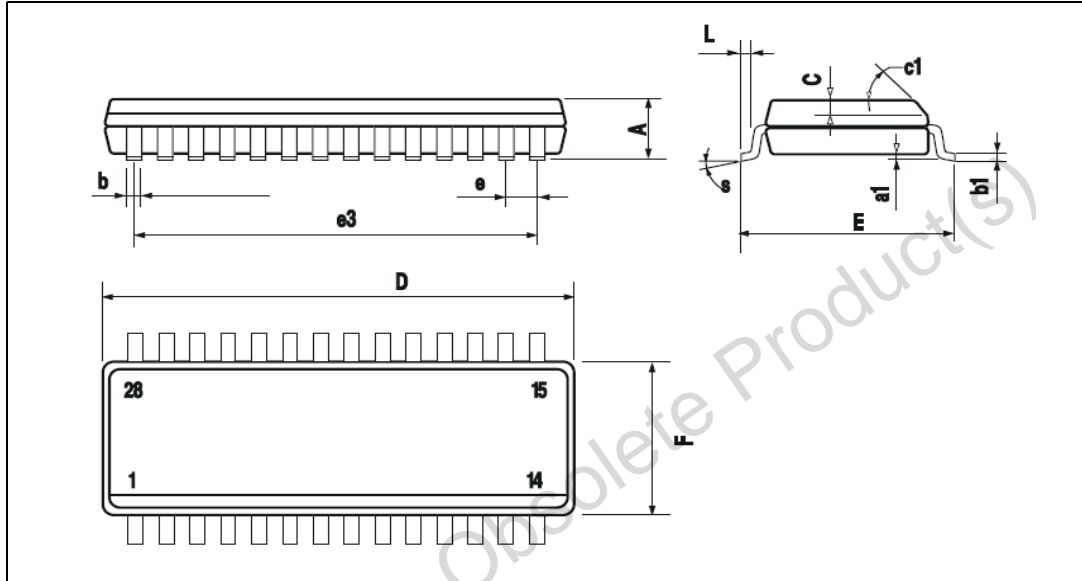
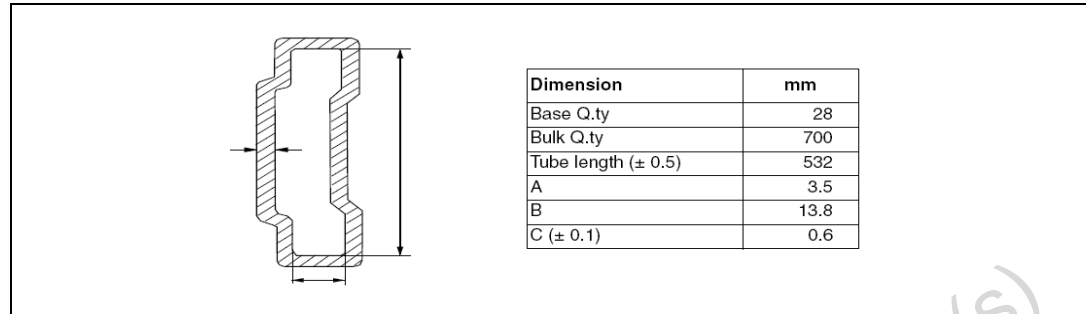

Table 21. SO-28 mechanical data

DIM	mm			inch		
	Min.	Typ	Max.	Min.	Typ.	Max.
A			2.65			0.104
a1	0.1		0.3	0.004		0.012
b	0.35		0.49	0.013		0.019
b1	0.23		0.32	0.009		0.012
C		0.5			0.020	
c1	45° (typ.)					
D	17.7		18.1	0.697		0.713
E	10		10.65	0.393		0.419
e		1.27			0.050	
e3		16.51			0.650	
F	7.4		7.6	0.291		0.299
L	0.4		1.27	0.016		0.050
S	8° (max.)					

5.2 SO-28 tube shipment

Figure 54. Tube dimensions (no suffix)



5.3 Tape and reel shipment

Figure 55. Tape and reel dimensions (suffix "13TR")

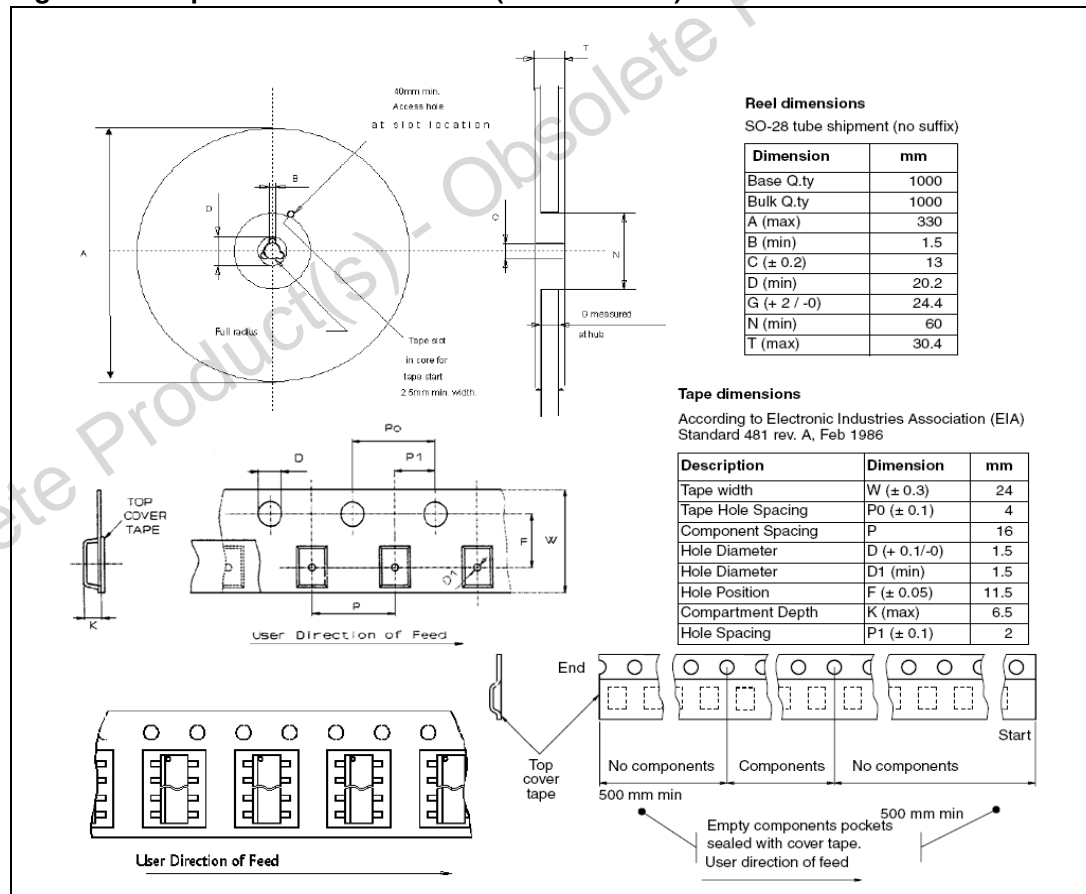

6 Revision history

Table 22. Document revision history

Date	Revision	Changes
01-Dec-2002	1	Initial release.
30-Jun-2004	2	Added thermal characterization Revision history table added Disclaimers updated (last page)
31-Aug-2006	3	Document formatted into new ST template Dimensions updated, see Figure 55: Tape and reel dimensions (suffix "13TR") on page 31 Inserted Chapter 4: Thermal data on page 26 Application diagram updated, see Figure 44: Application diagram bridge drivers on page 23 Updated disclaimer (last page) to include a mention about the use of ST products in automotive applications
30-Jun-2009	4	Updated Table 3: Thermal data . Updated note of Figure 47: SO-28 PC board . Updated Figure 48: Chipset configuration .
25-Sep-2013	5	Updated Disclaimer.

Please Read Carefully:

Information in this document is provided solely in connection with ST products. STMicroelectronics NV and its subsidiaries ("ST") reserve the right to make changes, corrections, modifications or improvements, to this document, and the products and services described herein at any time, without notice.

All ST products are sold pursuant to ST's terms and conditions of sale.

Purchasers are solely responsible for the choice, selection and use of the ST products and services described herein, and ST assumes no liability whatsoever relating to the choice, selection or use of the ST products and services described herein.

No license, express or implied, by estoppel or otherwise, to any intellectual property rights is granted under this document. If any part of this document refers to any third party products or services it shall not be deemed a license grant by ST for the use of such third party products or services, or any intellectual property contained therein or considered as a warranty covering the use in any manner whatsoever of such third party products or services or any intellectual property contained therein.

UNLESS OTHERWISE SET FORTH IN ST'S TERMS AND CONDITIONS OF SALE ST DISCLAIMS ANY EXPRESS OR IMPLIED WARRANTY WITH RESPECT TO THE USE AND/OR SALE OF ST PRODUCTS INCLUDING WITHOUT LIMITATION IMPLIED WARRANTIES OF MERCHANTABILITY, FITNESS FOR A PARTICULAR PURPOSE (AND THEIR EQUIVALENTS UNDER THE LAWS OF ANY JURISDICTION), OR INFRINGEMENT OF ANY PATENT, COPYRIGHT OR OTHER INTELLECTUAL PROPERTY RIGHT.

ST PRODUCTS ARE NOT DESIGNED OR AUTHORIZED FOR USE IN: (A) SAFETY CRITICAL APPLICATIONS SUCH AS LIFE SUPPORTING, ACTIVE IMPLANTED DEVICES OR SYSTEMS WITH PRODUCT FUNCTIONAL SAFETY REQUIREMENTS; (B) AERONAUTIC APPLICATIONS; (C) AUTOMOTIVE APPLICATIONS OR ENVIRONMENTS, AND/OR (D) AEROSPACE APPLICATIONS OR ENVIRONMENTS. WHERE ST PRODUCTS ARE NOT DESIGNED FOR SUCH USE, THE PURCHASER SHALL USE PRODUCTS AT PURCHASER'S SOLE RISK, EVEN IF ST HAS BEEN INFORMED IN WRITING OF SUCH USAGE, UNLESS A PRODUCT IS EXPRESSLY DESIGNATED BY ST AS BEING INTENDED FOR "AUTOMOTIVE, AUTOMOTIVE SAFETY OR MEDICAL" INDUSTRY DOMAINS ACCORDING TO ST PRODUCT DESIGN SPECIFICATIONS. PRODUCTS FORMALLY ESCC, QML OR JAN QUALIFIED ARE DEEMED SUITABLE FOR USE IN AEROSPACE BY THE CORRESPONDING GOVERNMENTAL AGENCY.

Resale of ST products with provisions different from the statements and/or technical features set forth in this document shall immediately void any warranty granted by ST for the ST product or service described herein and shall not create or extend in any manner whatsoever, any liability of ST.

ST and the ST logo are trademarks or registered trademarks of ST in various countries.

Information in this document supersedes and replaces all information previously supplied.

The ST logo is a registered trademark of STMicroelectronics. All other names are the property of their respective owners.

© 2013 STMicroelectronics - All rights reserved

STMicroelectronics group of companies

Australia - Belgium - Brazil - Canada - China - Czech Republic - Finland - France - Germany - Hong Kong - India - Israel - Italy - Japan - Malaysia - Malta - Morocco - Philippines - Singapore - Spain - Sweden - Switzerland - United Kingdom - United States of America

www.st.com