



TND525SS

Excellent Power Device Half-bridge Drive, Single SOIC8

ON Semiconductor®

<http://onsemi.com>

Features

- 2-input 2-output half-bridge drive
- Low side output supervisory circuit is built in (Simultaneous ON preventing circuit)
- Allows simplified configuration of driver circuit
- Withstand voltage of 600V is assured
- High-speed switching
- Monolithic structure
- Fully compatible input to LSTTL/CMOS
- Output current: 170mA Source, 340mA Sink
- Halogen free compliance

Specifications

Absolute Maximum Ratings at Ta=25°C (All voltage parameters are absolute voltage referenced to GND)

Parameter	Symbol	Conditions	Ratings	Unit
High Side Floating Supply Voltage	V _H		-0.3 to 625	V
High Side Floating Supply Offset Voltage	V _S		V _H -25 to V _H +0.3	V
High Side Output Voltage	V _{HOUT}		V _S -0.3 to V _H +0.3	V
Low Side Supply Voltage	V _L		-0.3 to 25	V
Low Side Output Voltage	V _{LOUT}		-0.3 to V _L +0.3	V
Logic Input Voltage (HIN, LIN)	V _{IN}		-0.3 to V _L +0.3	V
The Maximum Allowable Offset Voltage Supply dv/dt	dV _S /dt		50	V/ns
Allowable Power Dissipation	P _D	When mounted on ceramic substrate (1200mm ² ×0.8mm)	1.2	W
Junction Temperature	T _j		-55 to +150	°C
Storage Temperature	T _{stg}		-55 to +150	°C

Stresses exceeding Maximum Ratings may damage the device. Maximum Ratings are stress ratings only. Functional operation above the Recommended Operating Conditions is not implied. Extended exposure to stresses above the Recommended Operating Conditions may affect device reliability.

Package Dimensions

unit : mm (typ)

7072-006

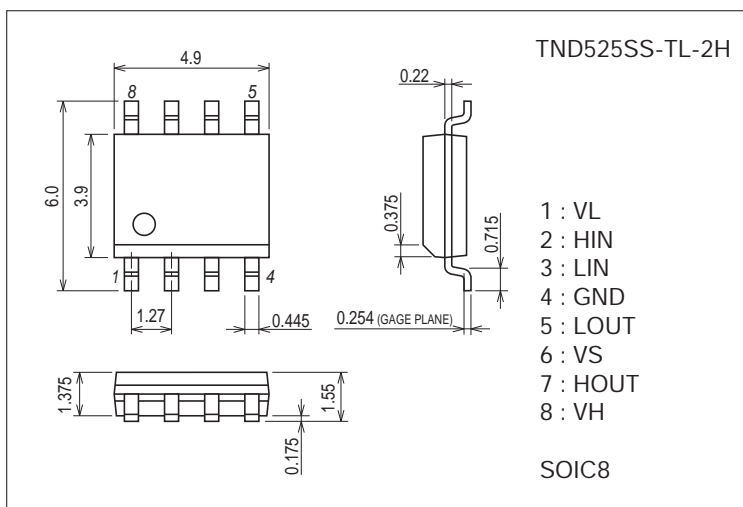

Product & Package Information

- Package : SIOC8
- JEITA, JEDEC : SC-87, SOT-96
- Minimum Packing Quantity : 2,500 pcs./reel

Packing Type: TL

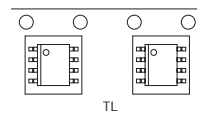

Marking

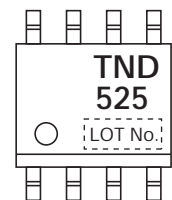

TND525SS

Recommend Operating Conditions at Ta=25°C

Parameter	Symbol	Conditions	Ratings	Unit
High Side Floating Supply Voltage	V _H		V _S +10 to V _S +20	V
High Side Floating Supply Offset Voltage	V _S	V _L =V _{HS} =15V	-5 to 600	V
High Side Output Voltage	V _{HOUT}		V _S to V _H	V
Low Side Supply Voltage	V _L		+10 to +20	V
Low Side Output Voltage	V _{LOUT}		0 to V _L	V
Logic Input Voltage (H _{IN} , L _{IN})	V _{IN}		0 to V _L	V
Ambient Temperature	Topr		-40 to +125	°C

AC Characteristics at Ta=25°C (V_L=V_{HS}=15V, C_L=1000pF)

Parameter	Symbol	Conditions	Ratings			Unit
			min	typ	max	
Turn-ON Delay Time	t _{on}	V _S =0V	70	100	130	ns
Turn-OFF Delay Time	t _{off}	V _S =0V	60	90	120	ns
Turn-ON Rise Time	t _r			80	110	ns
Turn-OFF Fall Time	t _f			35	55	ns
Delay Matching, HS and LS Turn-ON	Mt _{on}	Ht _{on} - Lt _{on}		5	30	ns
Delay Matching, HS and LS Turn-OFF	Mt _{off}	Ht _{off} - Lt _{off}		5	30	ns

DC Characteristics at Ta=25°C (V_L=V_{HS}=15V)

Parameter	Symbol	Conditions	Ratings			Unit
			min	typ	max	
Logic "1" Input Voltage	V _{IH}	V _L =10 to 20V	2.8			V
Logic "0" Input Voltage	V _{IL}	V _L =10 to 20V			0.8	V
High-level Output Voltage, V _{BIAS} -V _O	V _{OH}	V _{IN} =V _{IH} , I _O =0A			0.1	V
Low-level Output Voltage, V _O	V _{OL}	V _{IN} =V _{IL} , I _O =0A			0.1	V
Offset Supply Leakage Current	I _{LK}	V _H =V _S =600V			10	μA
Quiescent V _H Supply Current	I _{QH}	V _{IN} =0V		50	100	μA
		V _{IN} =V _L		60	100	μA
Quiescent V _L Supply Current	I _{QL}	V _{IN} =0V		130	230	μA
		V _{IN} =V _L		170	260	μA
Logic "1" Input Bias Current	I _{IN+}	V _{IN} =V _L		20	55	μA
Logic "0" Input Bias Current	I _{IN-}	V _{IN} =0V			1	μA
V _H Supply Undervoltage Positive Going Threshold	V _{HUV+}		7.6	8.9	9.9	V
V _H Supply Undervoltage Negative Going Threshold	V _{HUV-}		6.7	8.1	9.5	V
V _L Supply Undervoltage Positive Going Threshold	V _{LUV+}		7.6	8.9	9.9	V
V _L Supply Undervoltage Negative Going Threshold	V _{LUV-}		6.7	8.1	9.5	V
Output High Short Circuit Pulsed Current	I _{O+}	V _{OUT} =0V, PW≤10μs	170	200		mA
Output Low Short Circuit Pulsed Current	I _{O-}	V _{OUT} =15V, PW≤10μs	340	400		mA

Block Diagram

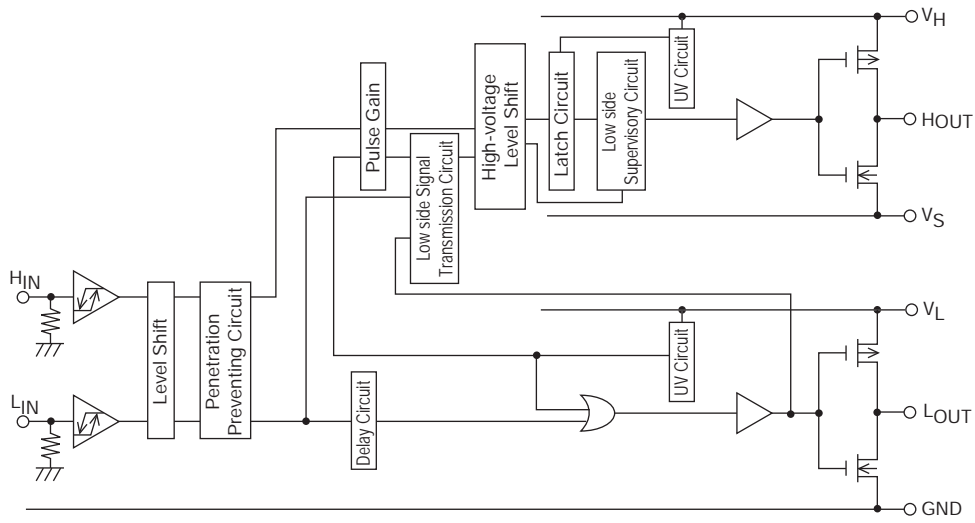

IT16886

Switching Time Waveform Definition

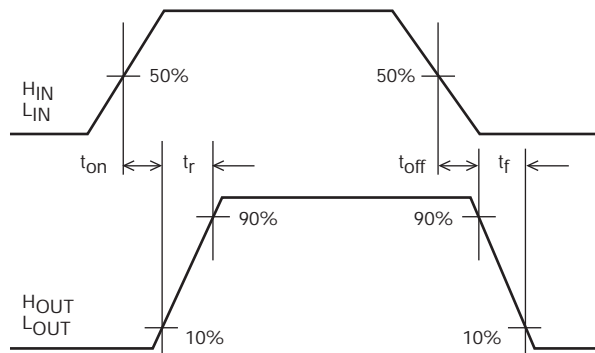

IT16887

Delay Matching Waveform Definition

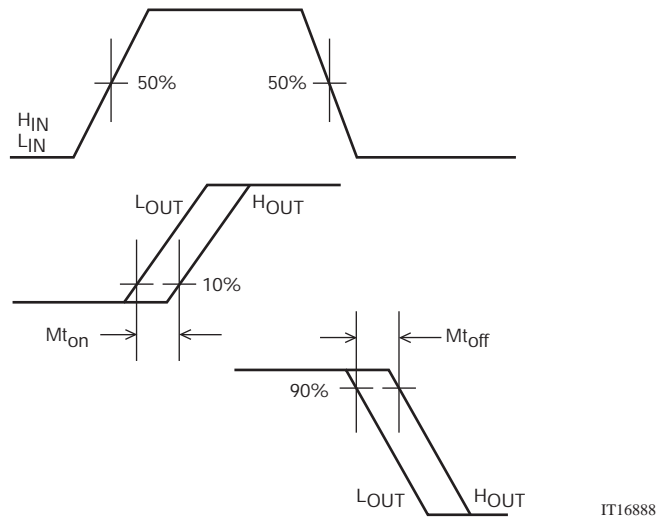

Switching Time Test Circuit

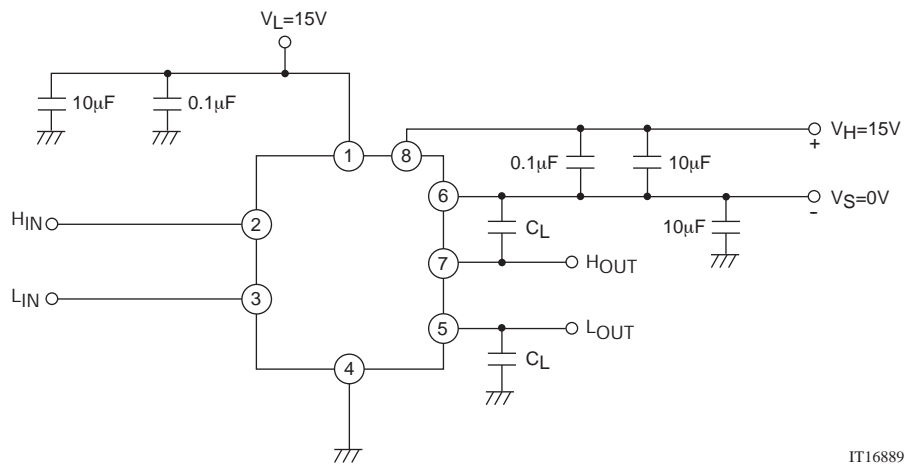

Ordering Information

Devices	Package	Shipping	memo
TND525SS-TL-2H	SOIC8	2,500pcs./reel	Pb Free and Halogen Free

TND525SS

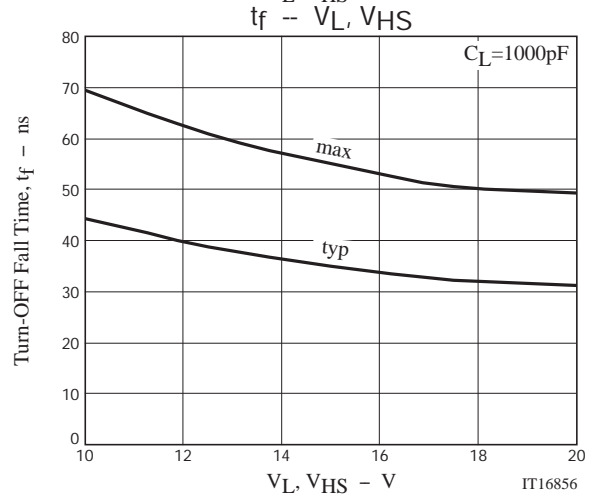
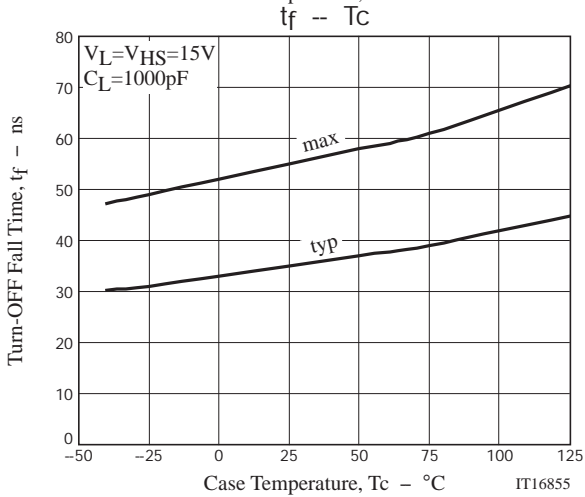
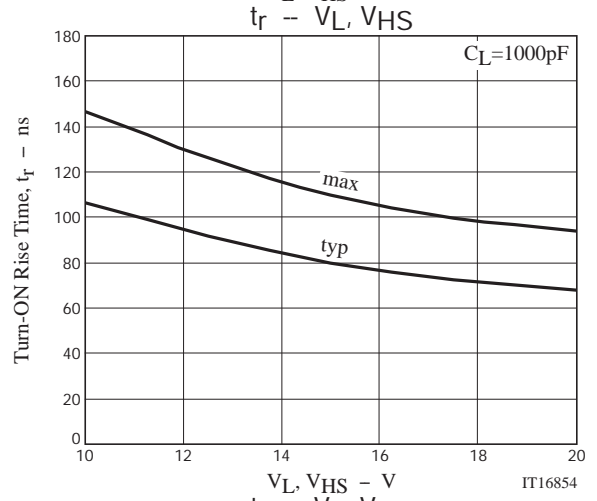
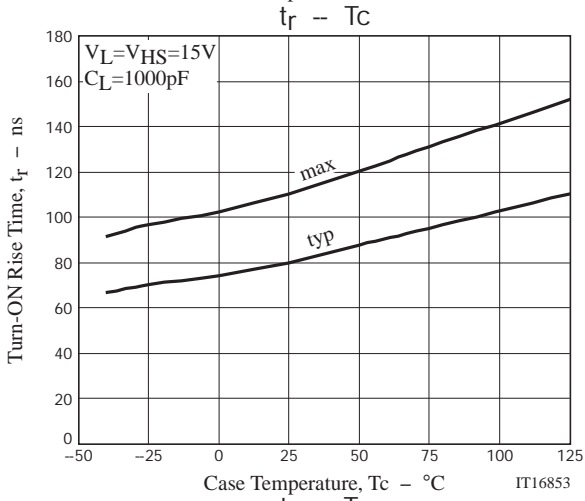
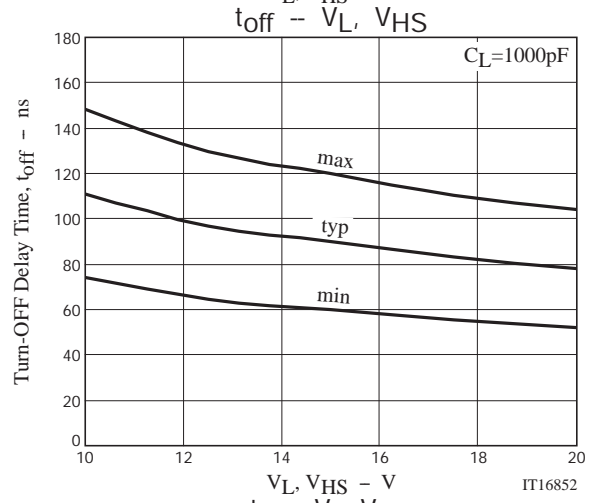
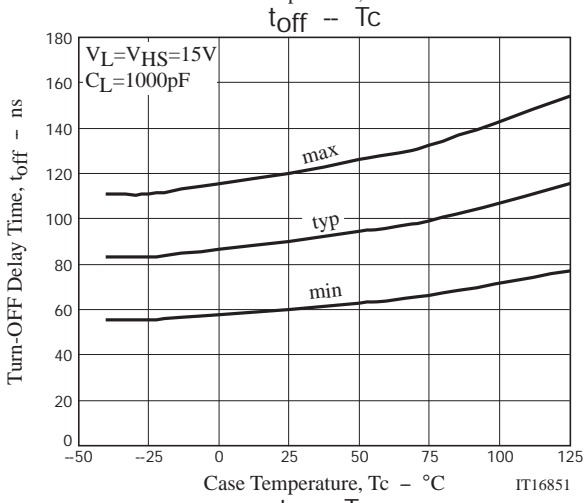
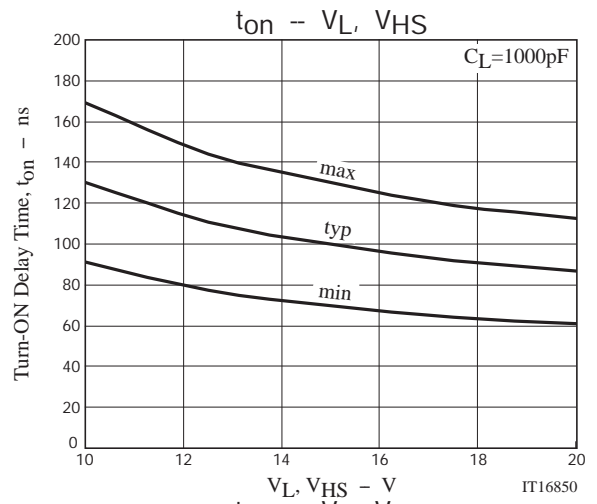
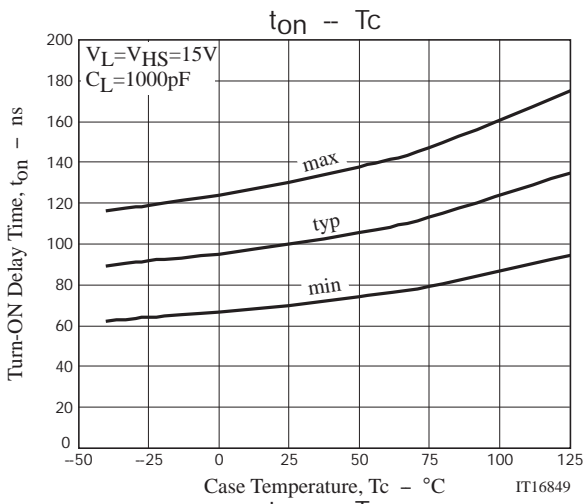

TND525SS

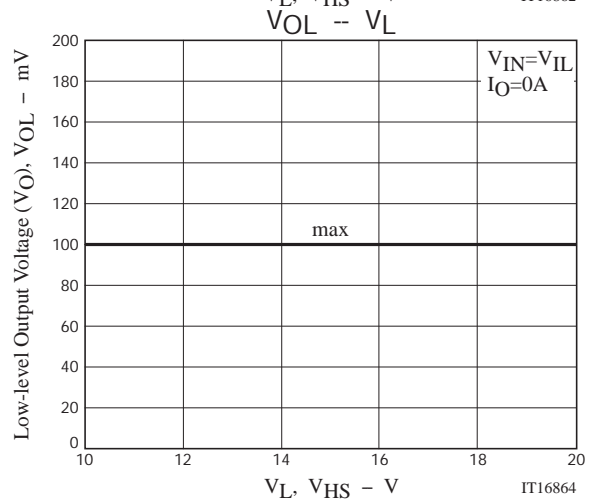
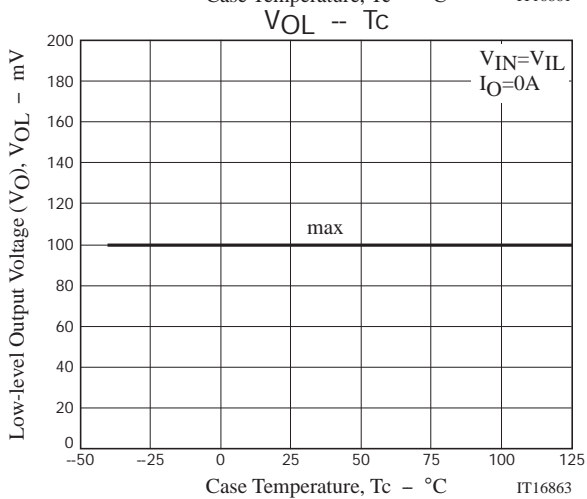
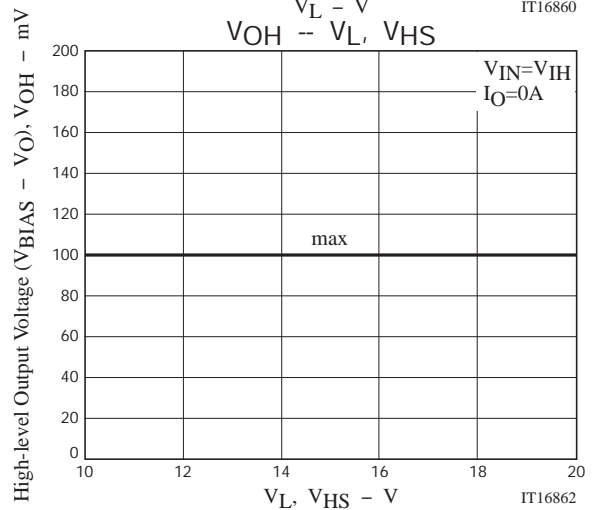
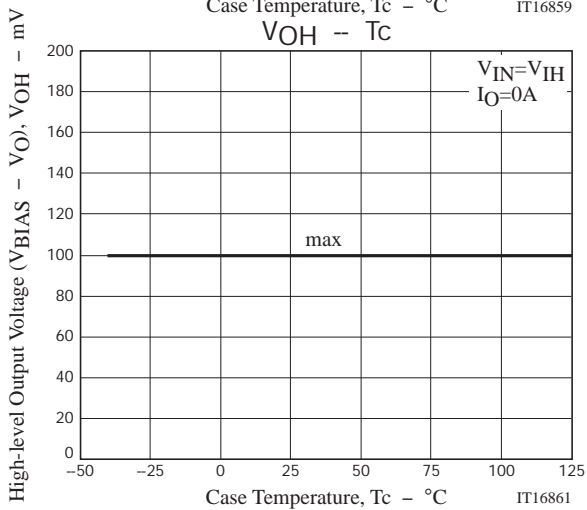
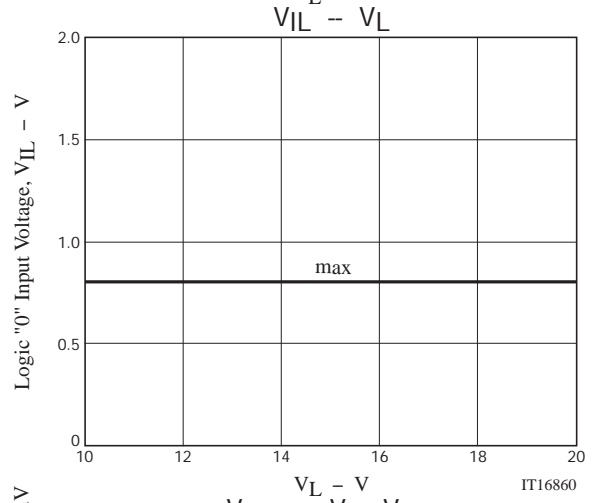
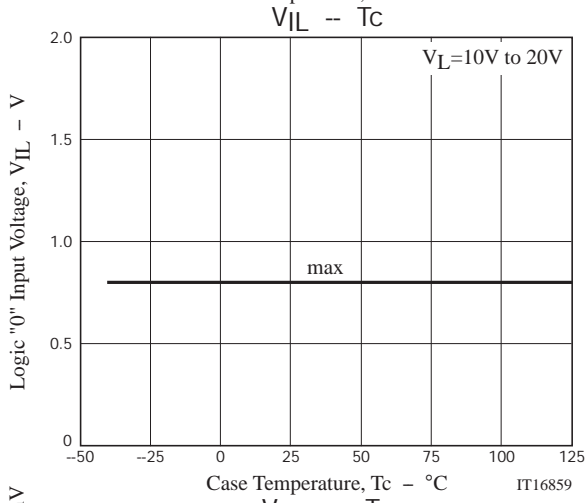
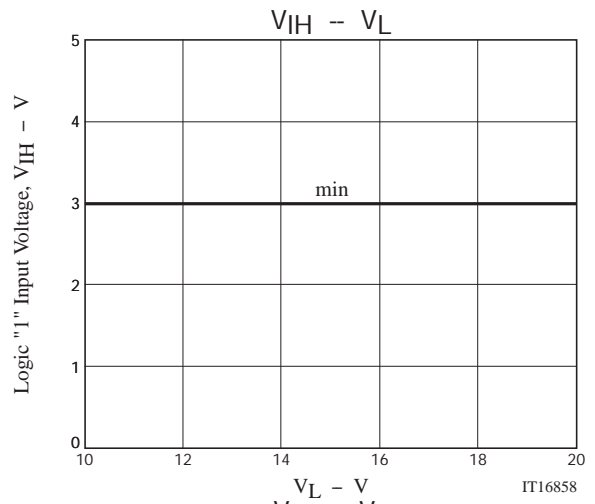
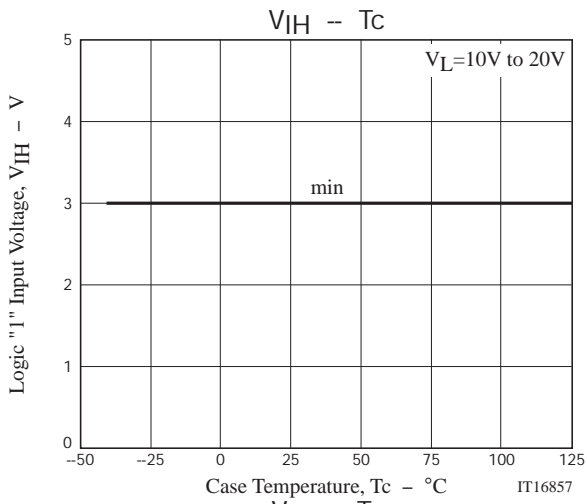

TND525SS

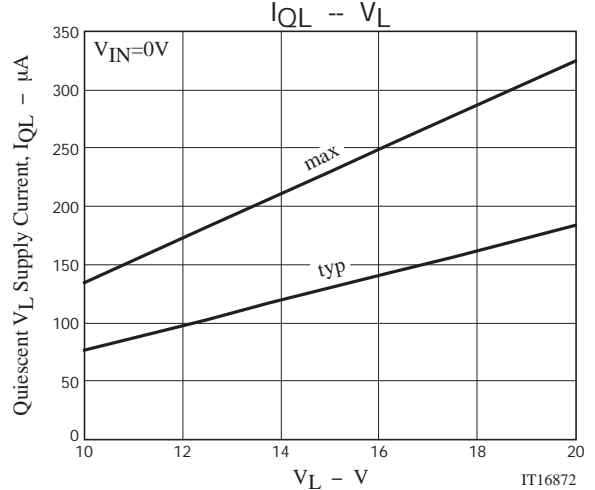
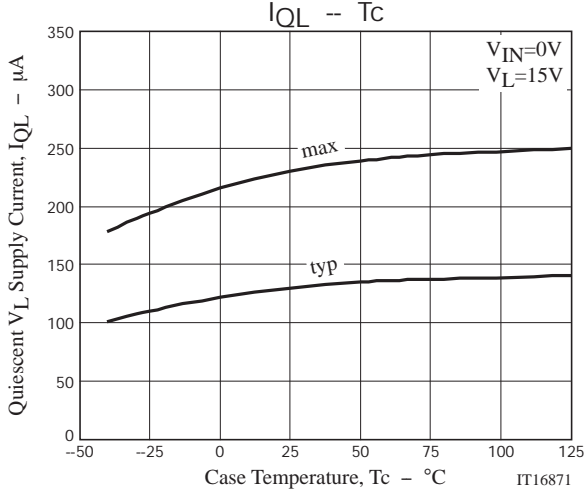
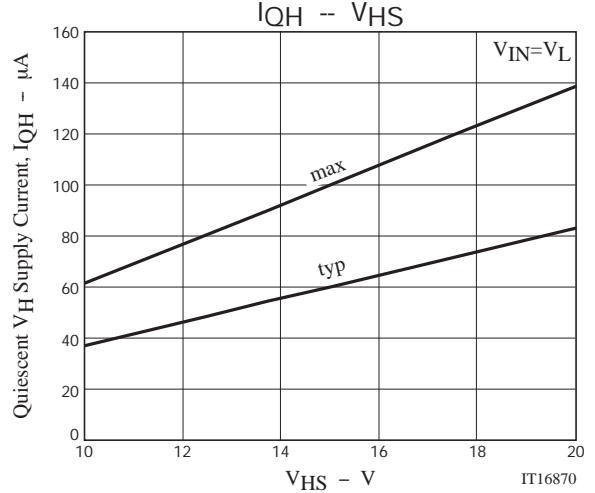
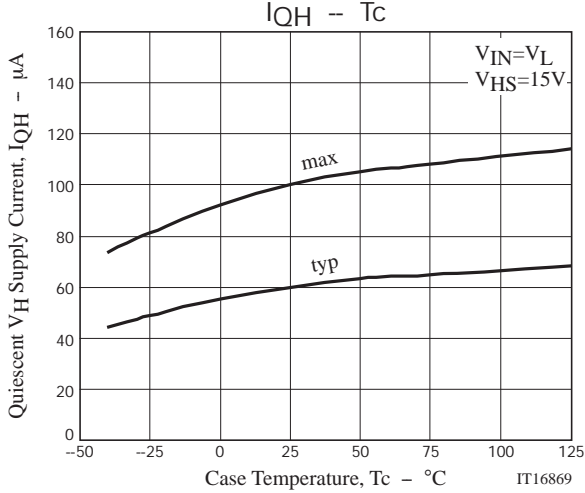
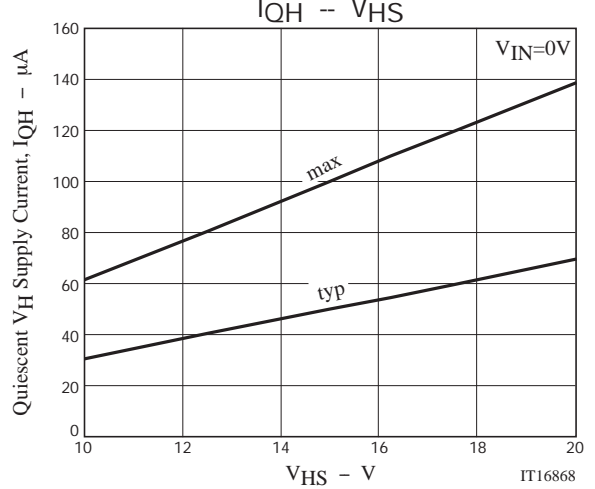
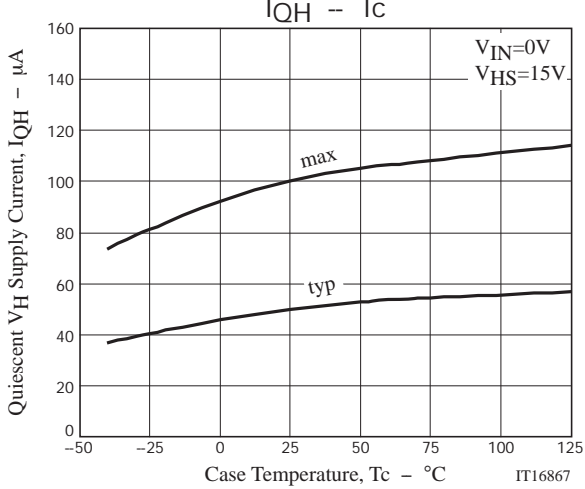
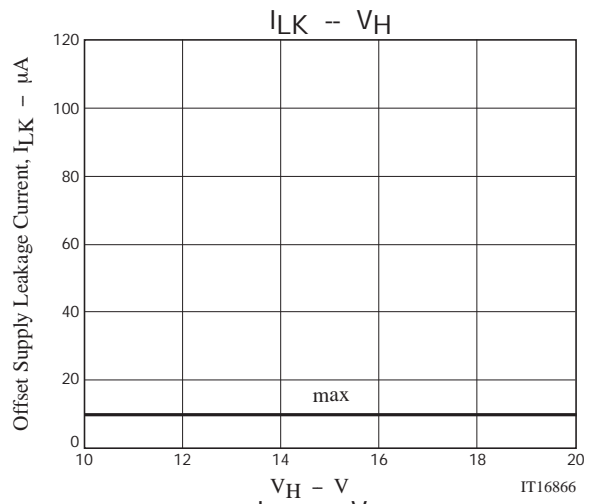
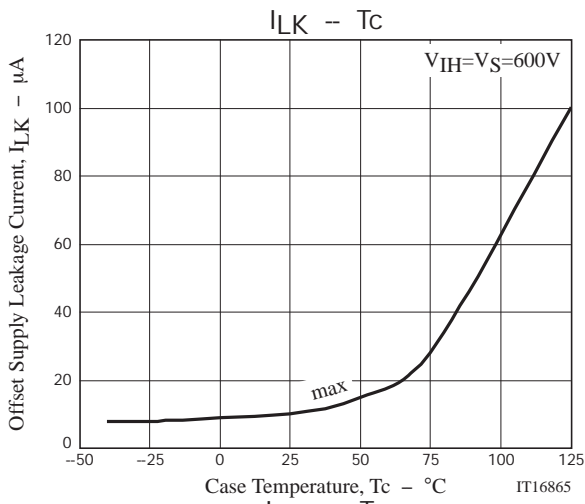

TND525SS

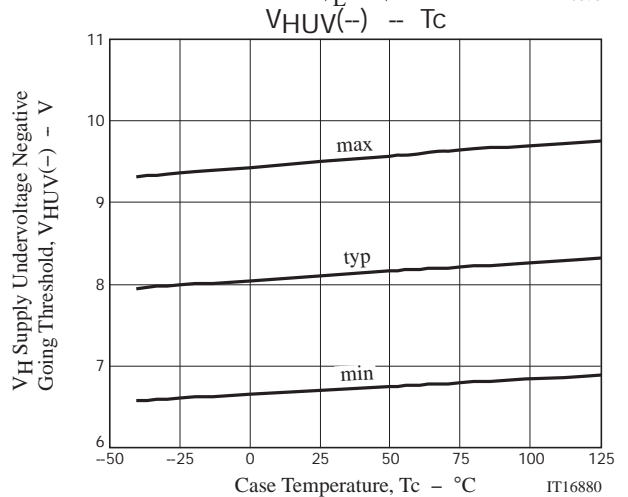
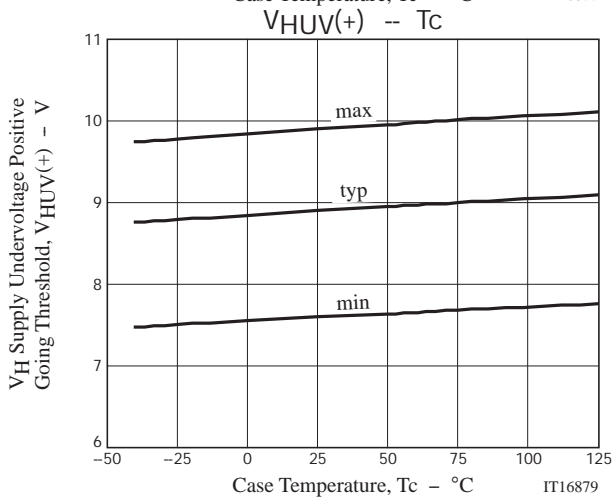
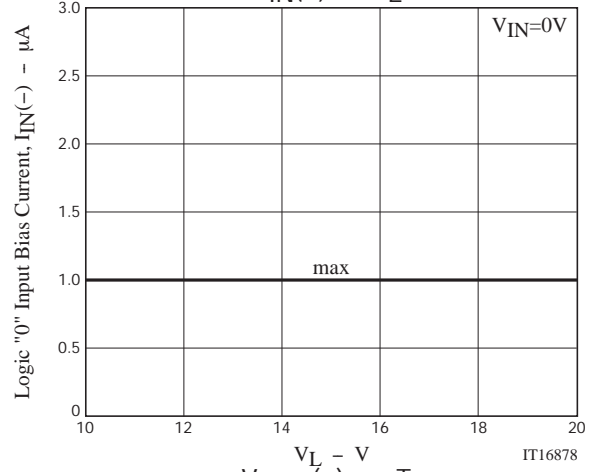
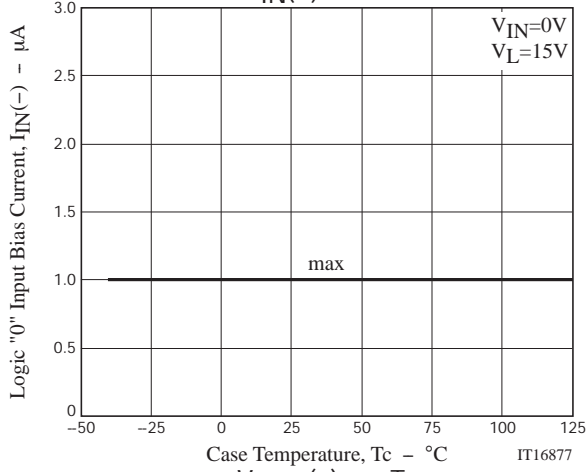
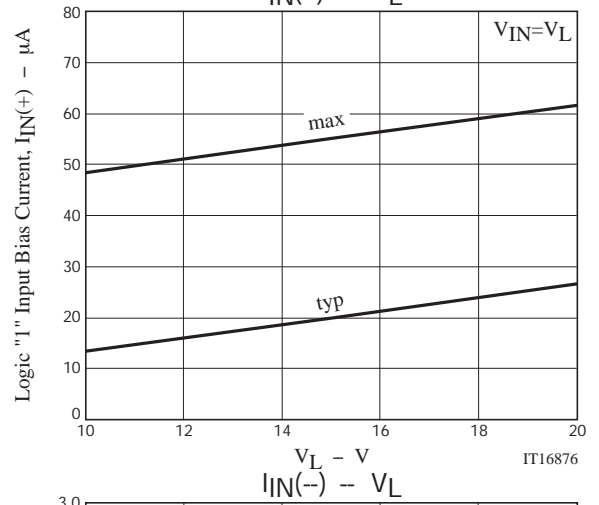
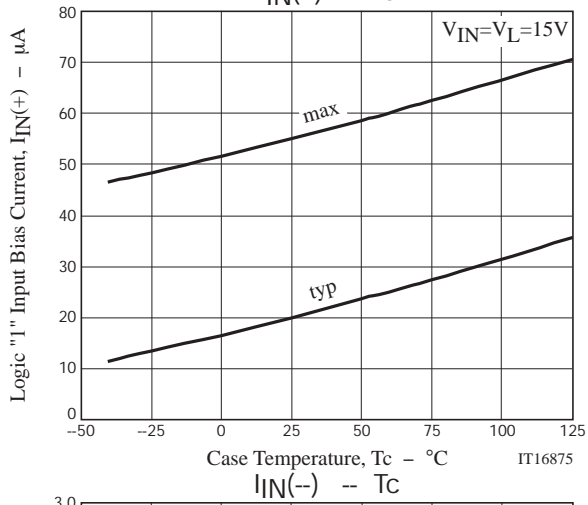
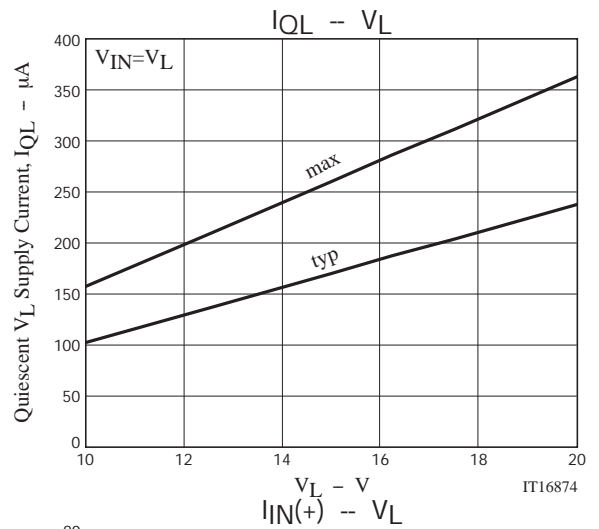
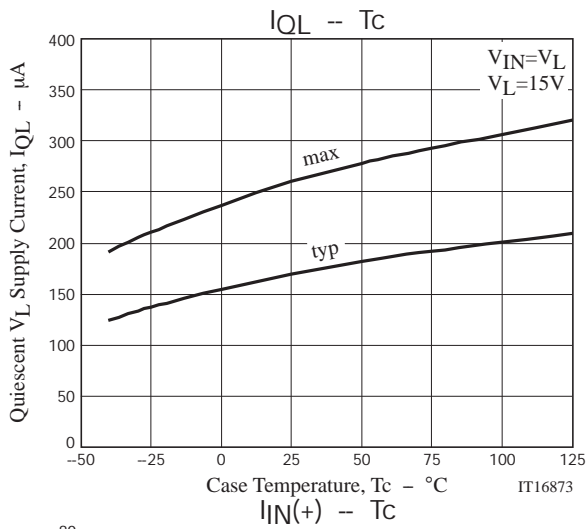

TND525SS

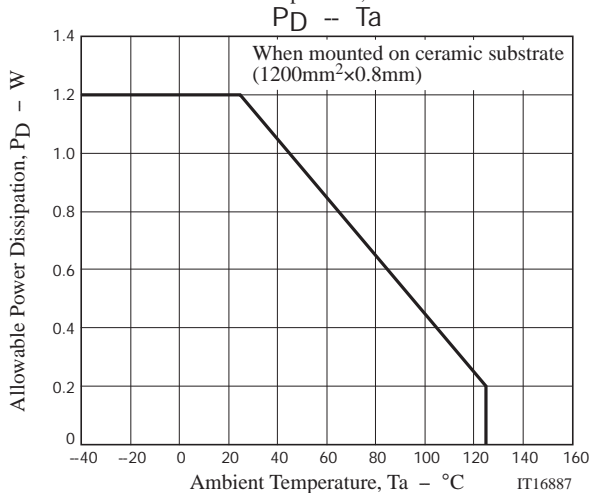
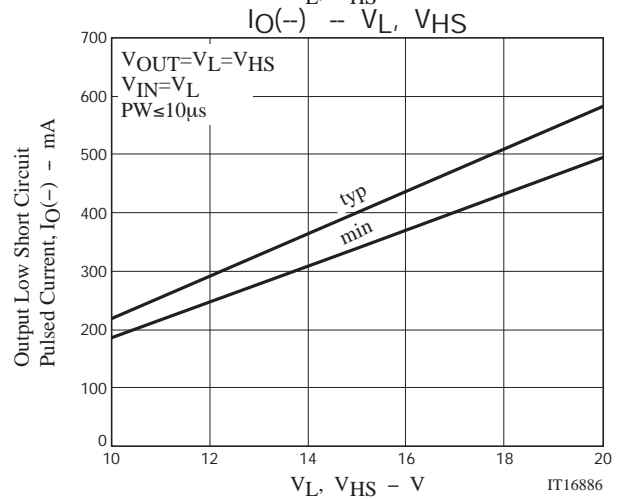
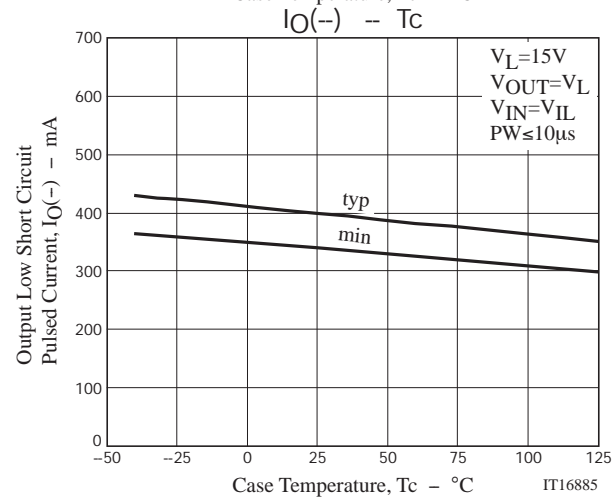
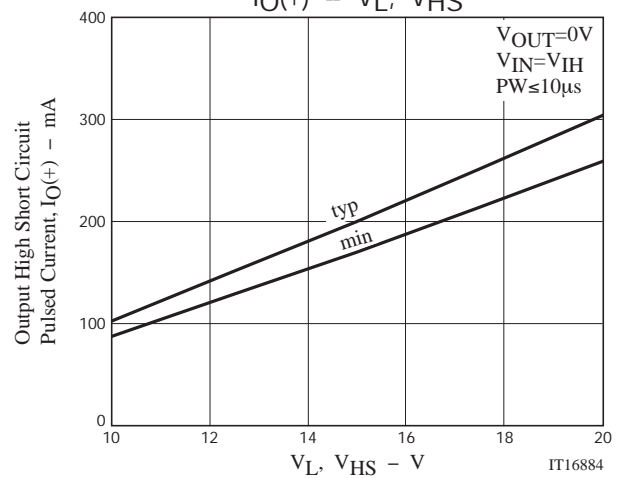
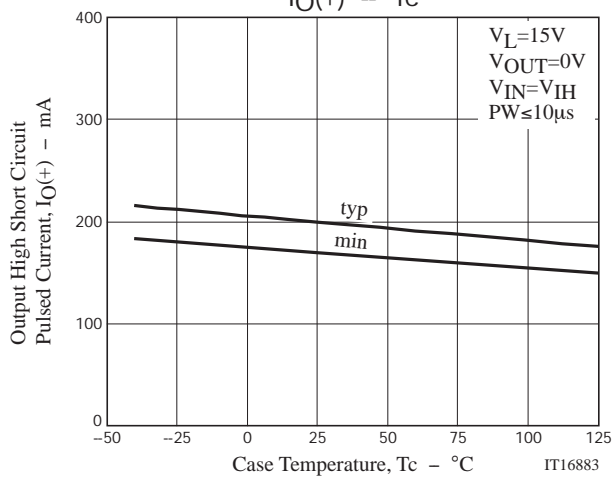
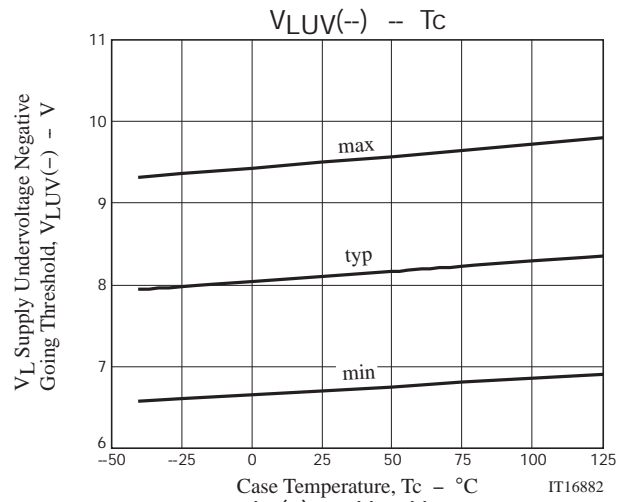
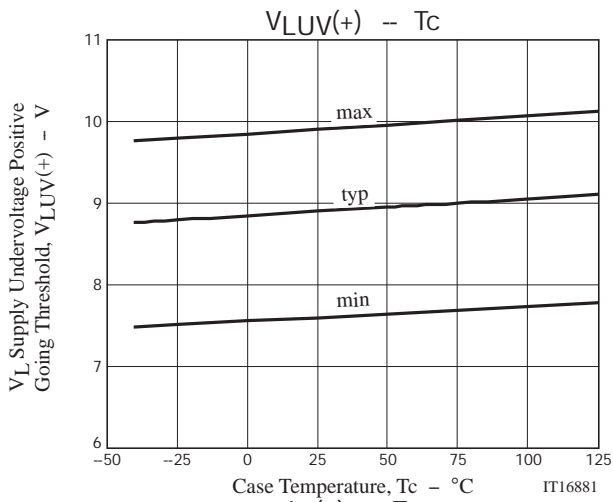

TND525SS

Taping Specification

TND525SS-TL-2H

1. Packing Format

Package Name	Carrier Tape Type	Maximum Number of devices contained (pcs)			Packing format	
		Reel	Inner box	Outer box	Inner BOX W206-112	Outer BOX W207-124
SOIC8	B202-101	2,500	12,500	25,000	5 reels contained Dimensions :mm(external) 340×95×340	2 inner boxes contained Dimensions :mm(external) 360×210×375

Packing method

Reel label, Inner box label (unit: mm)

Outer box label

It is a label at the time of factory shipments.
The form of a label may change in physical distribution process.

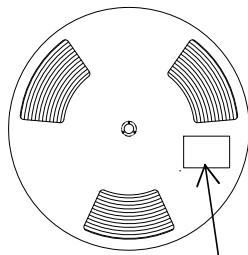

Type No. →
LOT No. →
Quantity →
Origin →

Reel label

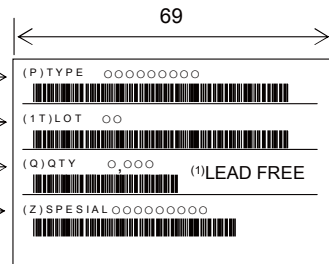

NOTE(1)

The LEAD FREE 4 description shows that it is complete lead free.

43
80

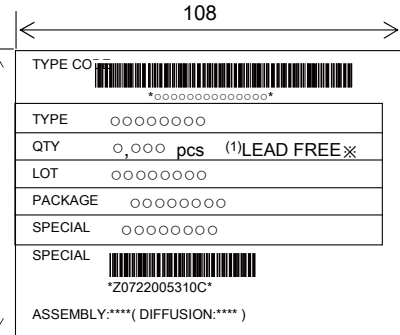

Label	JEITA Phase
LEAD FREE 4	JEITA Phase 3

2. Taping configuration

2-1. Carrier tape size (unit: mm)

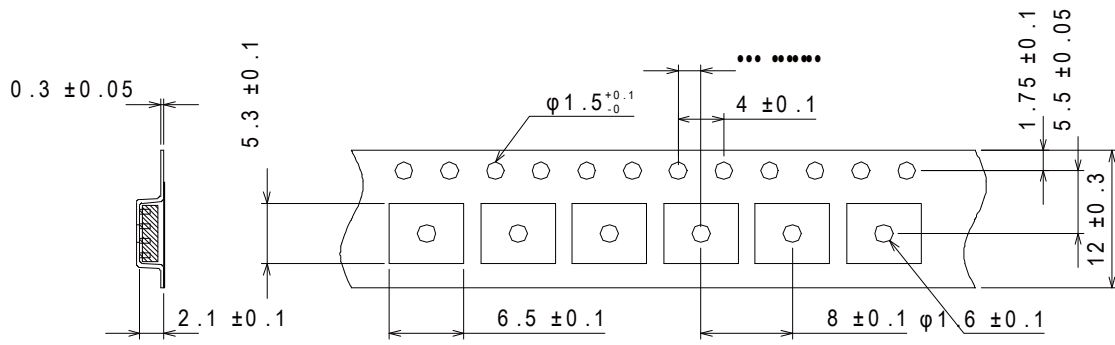

2-2. Device placement direction

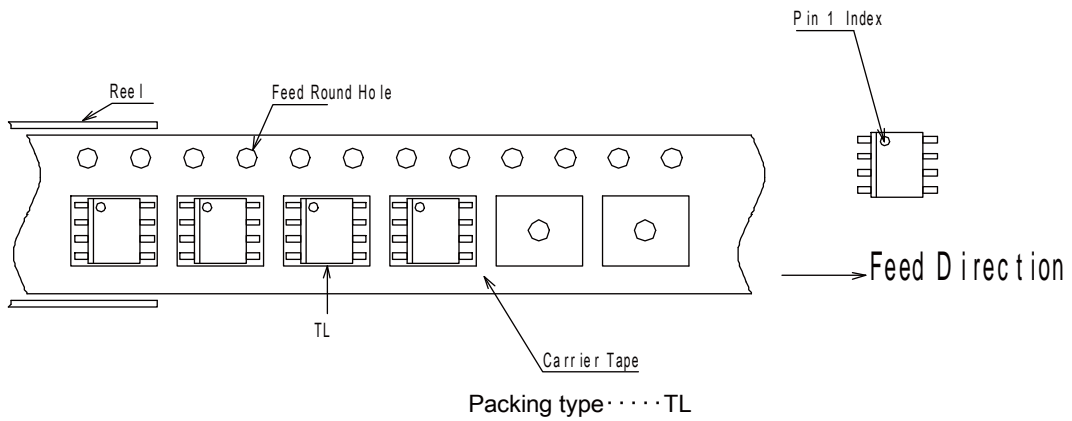

2-3. Leader portion and trailer portion (unit: mm)

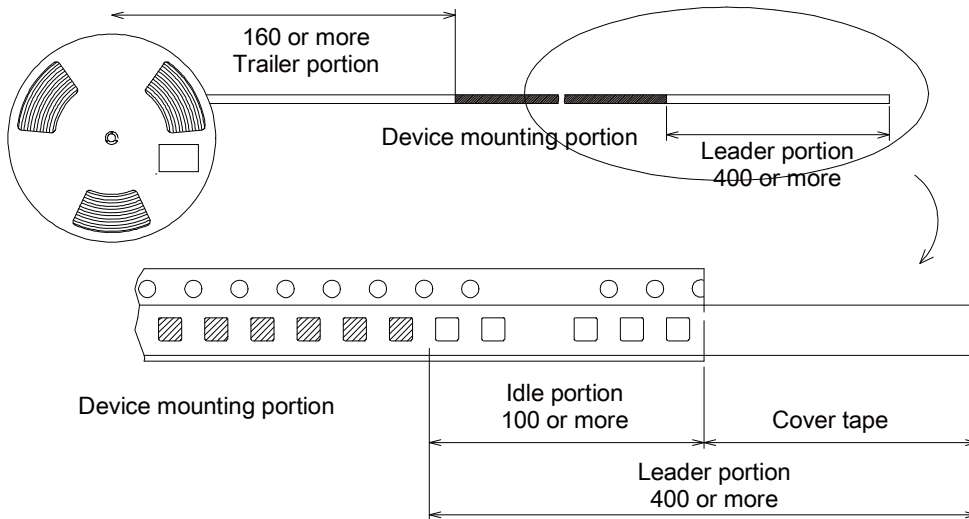

TND525SS

Outline Drawing TND525SS-TL-2H

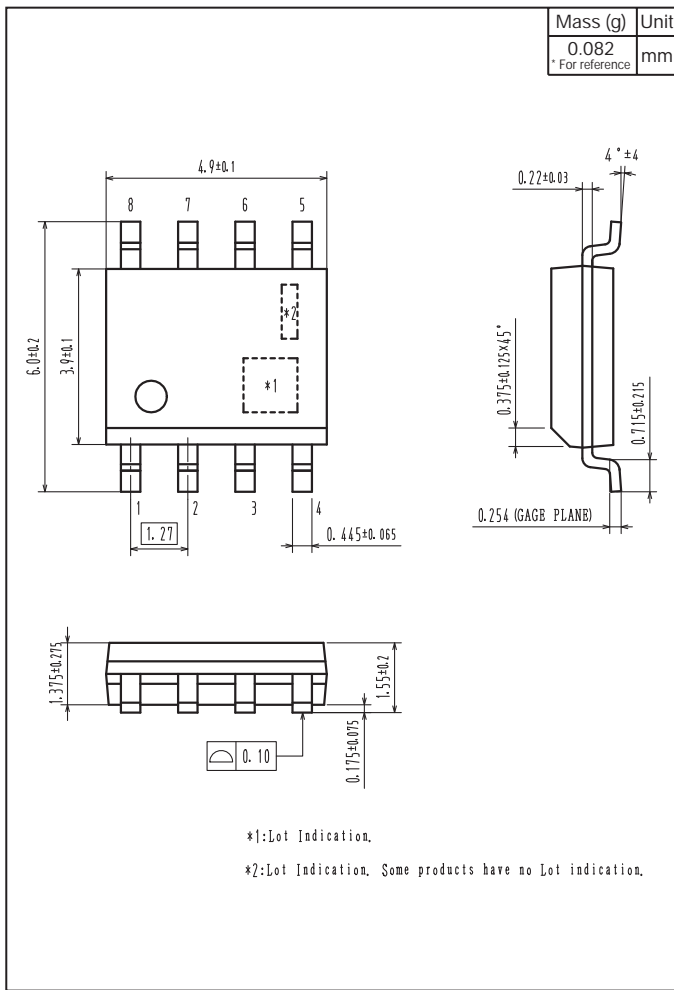

Land Pattern Example

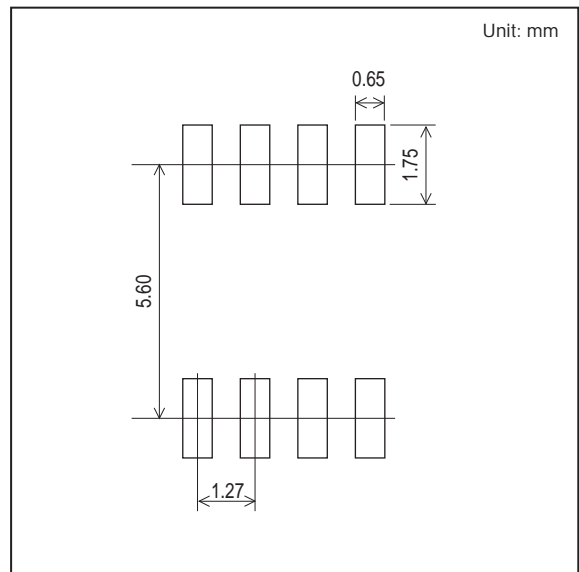

ON Semiconductor and the ON logo are registered trademarks of Semiconductor Components Industries, LLC (SCILLC). SCILLC owns the rights to a number of patents, trademarks, copyrights, trade secrets, and other intellectual property. A listing of SCILLC's product/patent coverage may be accessed at www.onsemi.com/site/pdf/Patent-Marking.pdf. SCILLC reserves the right to make changes without further notice to any products herein. SCILLC makes no warranty, representation or guarantee regarding the suitability of its products for any particular purpose, nor does SCILLC assume any liability arising out of the application or use of any product or circuit, and specifically disclaims any and all liability, including without limitation special, consequential or incidental damages. "Typical" parameters which may be provided in SCILLC data sheets and/or specifications can and do vary in different applications and actual performance may vary over time. All operating parameters, including "Typicals" must be validated for each customer application by customer's technical experts. SCILLC does not convey any license under its patent rights nor the rights of others. SCILLC products are not designed, intended, or authorized for use as components in systems intended for surgical implant into the body, or other applications intended to support or sustain life, or for any other application in which the failure of the SCILLC product could create a situation where personal injury or death may occur. Should Buyer purchase or use SCILLC products for any such unintended or unauthorized application, Buyer shall indemnify and hold SCILLC and its officers, employees, subsidiaries, affiliates, and distributors harmless against all claims, costs, damages, and expenses, and reasonable attorney fees arising out of, directly or indirectly, any claim of personal injury or death associated with such unintended or unauthorized use, even if such claim alleges that SCILLC was negligent regarding the design or manufacture of the part. SCILLC is an Equal Opportunity/Affirmative Action Employer. This literature is subject to all applicable copyright laws and is not for resale in any manner.