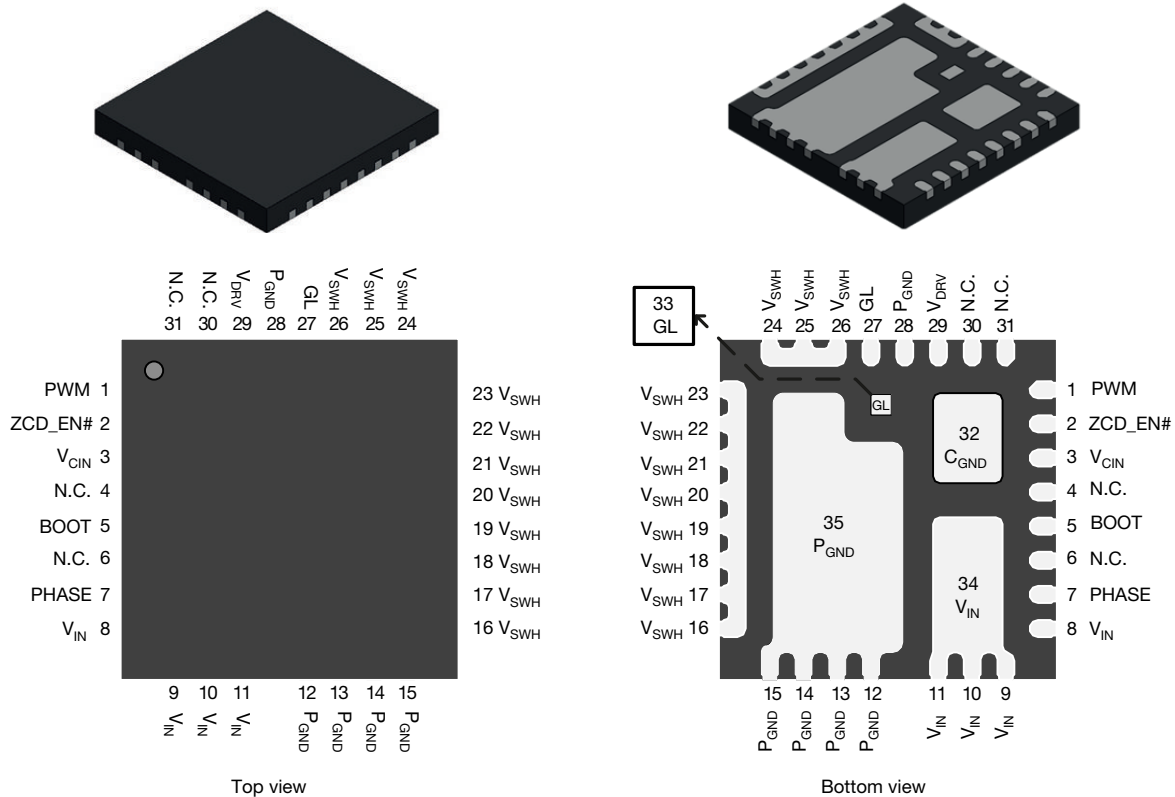
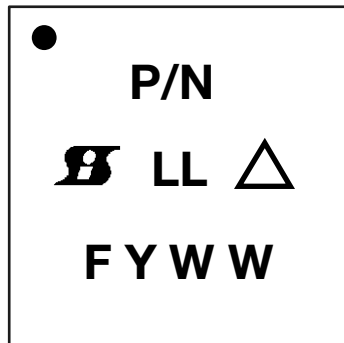

PINOUT CONFIGURATION

Fig. 2 - SiC621 Pin Configuration

PIN CONFIGURATION		
PIN NUMBER	NAME	FUNCTION
1	PWM	PWM input logic
2	ZCD_EN#	The ZCD_EN# pin enables or disables diode emulation. When ZCD_EN# is LOW, diode emulation is allowed. When ZCD_EN# is HIGH, continuous conduction mode is forced. ZCD_EN# can also be put in a high impedance mode by floating the pin. If both ZCD_EN# and PWM are floating, the device shuts down and consumes typically 3 μ A (10 μ A max.) current
3	V _{CIN}	Supply voltage for internal logic circuitry
5	BOOT	High-side driver bootstrap voltage
4, 6, 30, 31	N.C.	Not connected internally, can be left floating or connected to ground
7	PHASE	Return path of high-side gate driver
8 to 11, 34	V _{IN}	Power stage input voltage. Drain of high-side MOSFET
12 to 15, 28, 35	P _{GND}	Power ground
16 to 26	V _{SWH}	Phase node of the power stage
27, 33	GL	Low-side MOSFET gate signal
29	V _{DRV}	Supply voltage for internal gate driver
32	C _{GND}	Signal ground

ORDERING INFORMATION			
PART NUMBER	PACKAGE	MARKING CODE	OPTION
SiC621CD-T1-GE3	PowerPAK MLP55-31L	SiC621	5 V PWM optimized
SiC621DB		Reference board	

PART MARKING INFORMATION

- = pin 1 indicator
- P/N = part number code
- = Siliconix logo
- △ = ESD symbol
- F = assembly factory code
- Y = year code
- WW = week code
- LL = lot code

ABSOLUTE MAXIMUM RATINGS			
ELECTRICAL PARAMETER	CONDITIONS	LIMIT	UNIT
Input voltage	V_{IN}	-0.3 to +25	V
Control logic supply voltage	V_{CIN}	-0.3 to +7	
Drive supply voltage	V_{DRV}	-0.3 to +7	
Switch node (DC voltage)	V_{SWH}	-0.3 to +25	
Switch node (AC voltage) ⁽¹⁾		-7 to +32	
BOOT voltage (DC voltage)	V_{BOOT}	32	
BOOT voltage (AC voltage) ⁽²⁾		40	
BOOT to PHASE (DC voltage)	$V_{BOOT-PHASE}$	-0.3 to +7	
BOOT to PHASE (AC voltage) ⁽³⁾		-0.3 to +8	
All logic inputs and outputs (PWM, ZCD_EN#)		-0.3 to $V_{CIN} + 0.3$	
Max. transient DC current ⁽⁴⁾	$V_{IN} = 12\text{ V}$, $V_{OUT} = 0.74\text{ V}$, $f_{SW} = 585\text{ kHz}$, $L_{OUT} = 0.22\text{ }\mu\text{H}$ 10 ms duration with 1 % duty cycle, $T_A = 55\text{ }^\circ\text{C}$	90	A
Max. operating junction temperature	T_J	150	$^\circ\text{C}$
Ambient temperature	T_A	-40 to +125	
Storage temperature	T_{stg}	-65 to +150	
Electrostatic discharge protection	Human body model, JESD22-A114	2000	V
	Charged device model, JESD22-C101	1000	

Notes

- Stresses beyond those listed under “Absolute Maximum Ratings” may cause permanent damage to the device. These are stress ratings only, and functional operation of the device at these or any other conditions beyond those indicated in the operational sections of the specifications is not implied. Exposure to absolute maximum rating conditions for extended periods may affect device reliability
- ⁽¹⁾ The specification values indicated “AC” is V_{SWH} to $P_{GND} - 8\text{ V}$ (< 20 ns, 10 μJ), min. and 32 V (< 50 ns), max.
- ⁽²⁾ The specification value indicates “AC voltage” is V_{BOOT} to P_{GND} , 40 V (< 50 ns) max.
- ⁽³⁾ The specification value indicates “AC voltage” is V_{BOOT} to V_{PHASE} , 8 V (< 50 ns) max.
- ⁽⁴⁾ This max. transient DC current is guaranteed by using Vishay evaluation board with 6 layers of PCB with one-ounce copper for each layer. Transient step is from 35 A steady state to 90 A peak

RECOMMENDED OPERATING RANGE				
ELECTRICAL PARAMETER	MINIMUM	TYPICAL	MAXIMUM	UNIT
Input voltage (V_{IN})	4.5	-	18	V
Drive supply voltage (V_{DRV}) ⁽¹⁾	4.5	5	5.5	
Control logic supply voltage (V_{CIN}) ⁽¹⁾	4.5	5	5.5	
BOOT to PHASE ($V_{BOOT-PHASE}$, DC voltage)	4	4.5	5.5	
Thermal resistance from junction to ambient	-	10.6	-	$^\circ\text{C/W}$
Thermal resistance from junction to case	-	1.6	-	

Note

- ⁽¹⁾ The V_{CIN} supply has under voltage lockout (UVLO) protection. For this reason, V_{DRV} and V_{CIN} should be biased from the same supply



ELECTRICAL SPECIFICATIONS						
(ZCD_EN# = 5 V, V _{IN} = 12 V, V _{DRV} and V _{CIN} = 5 V, T _A = 25 °C)						
PARAMETER	SYMBOL	TEST CONDITION	LIMITS			UNIT
			MIN.	TYP.	MAX.	
POWER SUPPLY						
Control logic supply current	I _{VCIN}	V _{PWM} = FLOAT	30	80	130	μA
		V _{PWM} = FLOAT, V _{ZCD_EN#} = 0 V	65	120	185	
		f _S = 300 kHz, D = 0.1	225	300	400	
Drive supply current	I _{VDRV}	f _S = 300 kHz, D = 0.1	5	15	25	mA
		f _S = 1 MHz, D = 0.1	30	50	75	
PS4 mode supply current	I _{VCIN} + I _{VDRV}	V _{PWM} = V _{ZCD_EN#} = FLOAT, T _A = -10 °C to +100 °C	1	3	9	μA
BOOTSTRAP SUPPLY						
Bootstrap diode forward voltage	V _F	I _F = 2 mA	0.45	0.55	0.70	V
PWM CONTROL INPUT						
Rising threshold	V _{TH_PWM_R}	V _{PWM} = FLOAT	3.6	3.9	4.2	V
Falling threshold	V _{TH_PWM_F}		0.72	1	1.3	
Tri-state voltage	V _{TRI}		2.3	2.5	2.7	
Tri-state rising threshold	V _{TRI_TH_R}		1.1	1.35	1.6	
Tri-state falling threshold	V _{TRI_TH_F}		3.4	3.7	4	
Tri-state rising threshold hysteresis	V _{HYS_TRI_R}		200	325	475	
Tri-state falling threshold hysteresis	V _{HYS_TRI_F}	105	200	375		
PWM input current	I _{PWM}	V _{PWM} = 5 V	180	250	350	μA
		V _{PWM} = 0 V	-180	-250	-350	
ZCD_EN# CONTROL INPUT						
Rising threshold	V _{TH_ZCD_EN#_R}	V _{ZCD_EN#} = FLOAT	3.3	3.6	3.9	V
Falling threshold	V _{TH_ZCD_EN#_F}		1.1	1.4	1.7	
Tri-state voltage	V _{TRI_ZCD_EN#}		2.3	2.5	2.7	
Tri-state rising threshold	V _{TRI_ZCD_EN#_R}		1.5	1.8	2.1	
Tri-state falling threshold	V _{TRI_ZCD_EN#_F}		2.9	3.15	3.4	
Tri-state rising threshold hysteresis	V _{HYS_TRI_ZCD#_R}		100	375	650	
Tri-state falling threshold hysteresis	V _{HYS_TRI_ZCD#_F}	100	450	800		
PWM input current	I _{ZCD_EN#}	V _{ZCD_EN#} = 5 V	25	50	100	μA
		V _{ZCD_EN#} = 0 V	-25	-50	-100	
PS4 exit latency	t _{PS4EXIT}		0.5	2.5	5	μs
TIMING SPECIFICATIONS						
Tri-state to GH/GL rising propagation delay	t _{PD_TRI_R}	No load, see fig. 4	10	20	35	ns
Tri-state hold-off time	t _{TSHO}		85	150	225	
GH - turn off propagation delay ⁽²⁾	t _{PD_OFF_GH}		10	20	35	
GH - turn on propagation delay (dead time rising)	t _{PD_ON_GH}		8	15	30	
GL - turn off propagation delay	t _{PD_OFF_GL}		10	20	35	
GL - turn on propagation delay ⁽²⁾ (dead time falling)	t _{PD_ON_GL}		10	20	35	
PROTECTION						
Under voltage lockout	V _{UVLO}	V _{CIN} rising, on threshold	2.5	3.2	3.7	V
		V _{CIN} falling, off threshold	2.4	2.9	3.4	
Under voltage lockout hysteresis	V _{UVLO_HYST}		100	300	500	mV

Notes

- (1) Typical limits are established by characterization and are not production tested
- (2) Guaranteed by design



DETAILED OPERATIONAL DESCRIPTION

PWM Input with Tri-State Function

The PWM input receives the PWM control signal from the VR controller IC. The PWM input is designed to be compatible with standard controllers using two state logic (H and L) and advanced controllers that incorporate tri-state logic (H, L and tri-state) on the PWM output. For two state logic, the PWM input operates as follows. When PWM is driven above $V_{PWM_TH_R}$ the low-side is turned on and the high-side is turned on. When PWM input is driven below $V_{PWM_TH_F}$ the high-side is turned off and the low-side is turned on. For tri-state logic, the PWM input operates as previously stated for driving the MOSFETs. However, there is a third state that is entered as the PWM output of tri-state compatible controller enters its high impedance state during shut-down. The high impedance state of the controller's PWM output allows the SiC621 to pull the PWM input into the tri-state region (see definition of PWM logic and tri-state, fig. 4). If the PWM input stays in this region for the tri-state hold-off period, t_{TSHO} , both high-side and low-side MOSFETs are turned off. This function allows the VR phase to be disabled without negative output voltage swing caused by inductor ringing and saves a Schottky diode clamp. The PWM and tri-state regions are separated by hysteresis to prevent false triggering. The SiC621 incorporates PWM voltage thresholds that are compatible with 5 V.

Diode Emulation Mode and PS4 Mode (ZCD_EN#)

The ZCD_EN# pin enables or disables diode emulation mode. When ZCD_EN# is driven below $V_{TH_ZCD_EN\#_F}$, diode emulation is allowed. When ZCD_EN# is driven above $V_{TH_ZCD_EN\#_R}$, continuous conduction mode is forced. Diode emulation mode allows for higher converter efficiency under light load situations. With diode emulation active, the SiC621 will detect the zero current crossing of the output inductor and turn off the low-side MOSFET. This ensures that discontinuous conduction mode (DCM) is achieved. Diode emulation is asynchronous to the PWM signal, therefore, the SiC621 will respond to the ZCD_EN# input immediately after it changes state.

The ZCD_EN# pin can be floated resulting in a high impedance state. High impedance on the input of ZCD_EN# combined with a tri-stated PWM output will shut down the SiC621, reducing current consumption to typically 5 μ A. This is an important feature in achieving the low standby current requirements required in the PS4 state in ultrabooks and notebooks.

Voltage Input (V_{IN})

This is the power input to the drain of the high-side power MOSFET. This pin is connected to the high power intermediate BUS rail.

Switch Node (V_{SWH} and PHASE)

The switch node, V_{SWH} , is the circuit power stage output. This is the output applied to the power inductor and output filter to deliver the output for the buck converter. The PHASE pin is internally connected to the switch node V_{SWH} . This pin is to be used exclusively as the return pin for the BOOT capacitor.

Ground Connections (C_{GND} and P_{GND})

P_{GND} (power ground) should be externally connected to C_{GND} (control signal ground). The layout of the printed circuit board should be such that the inductance separating C_{GND} and P_{GND} is minimized. Transient differences due to inductance effects between these two pins should not exceed 0.5 V

Control and Drive Supply Voltage Input (V_{DRV} , V_{CIN})

V_{CIN} is the bias supply for the gate drive control IC. V_{DRV} is the bias supply for the gate drivers. It is recommended to separate these pins through a resistor. This creates a low pass filtering effect to avoid coupling of high frequency gate drive noise into the IC.

Bootstrap Circuit (BOOT)

The internal bootstrap diode and an external bootstrap capacitor form a charge pump that supplies voltage to the BOOT pin. An integrated bootstrap diode is incorporated so that only an external capacitor is necessary to complete the bootstrap circuit. Connect a boot strap capacitor with one leg tied to BOOT pin and the other tied to PHASE pin.

Shoot-Through Protection and Adaptive Dead Time

The SiC621 has an internal adaptive logic to avoid shoot through and optimize dead time. The shoot through protection ensures that both high-side and low-side MOSFETs are not turned on at the same time. The adaptive dead time control operates as follows. The HS and LS gate voltages are monitored to prevent the one turning on from tuning on until the other's gate voltage is sufficiently low (< 1 V). Built in delays also ensure that one power MOS is completely off, before the other can be turned on. This feature helps to adjust dead time as gate transitions change with respect to output current and temperature. Change with respect to output current and temperature.

Under Voltage Lockout (UVLO)

During the start up cycle, the UVLO disables the gate drive holding high-side and low-side MOSFET gates low until the supply voltage rail has reached a point at which the logic circuitry can be safely activated. The SiC621 also incorporates logic to clamp the gate drive signals to zero when the UVLO falling edge triggers the shutdown of the device.

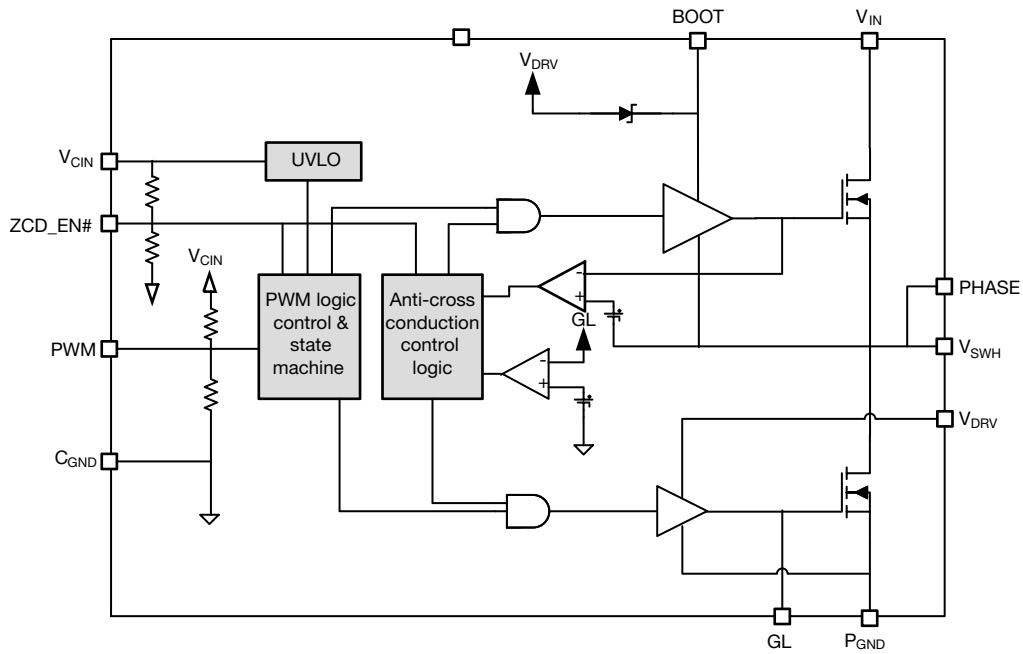
FUNCTIONAL BLOCK DIAGRAM

Fig. 3 - SiC621 Functional Block Diagram

DEVICE TRUTH TABLE			
ZCD_EN#	PWM	GH	GL
Tri-state	X	L	L
L	L	L	H, $I_L > 0 A$ L, $I_L < 0 A$
L	H	H	L
L	Tri-state	L	L
H	L	L	H
H	H	H	L
H	Tri-state	L	L

PWM TIMING DIAGRAM

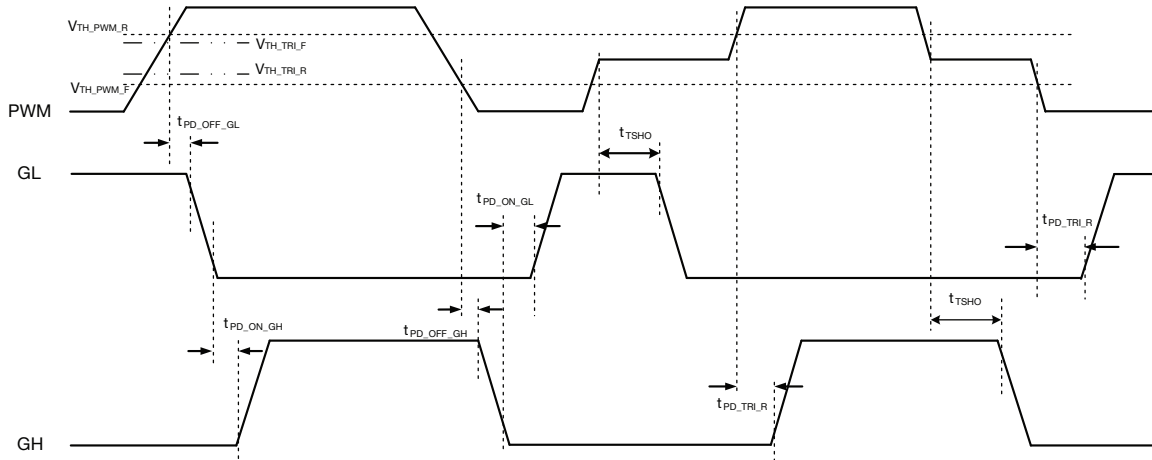

Fig. 4 - Definition of PWM Logic and Tri-state

ZCD_EN# - PS4 EXIT TIMING

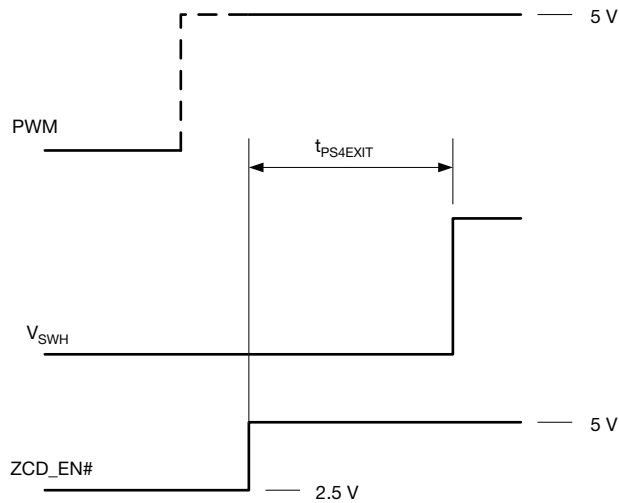
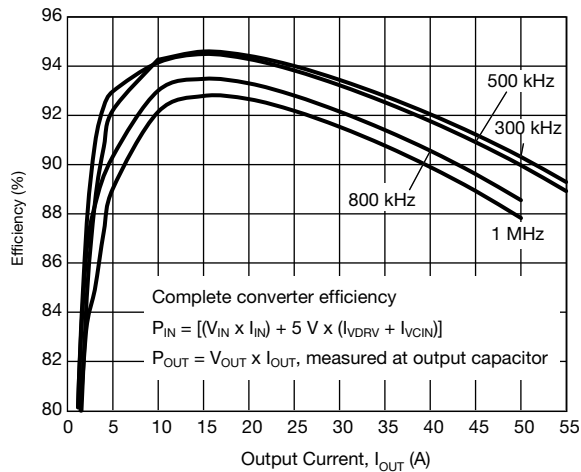
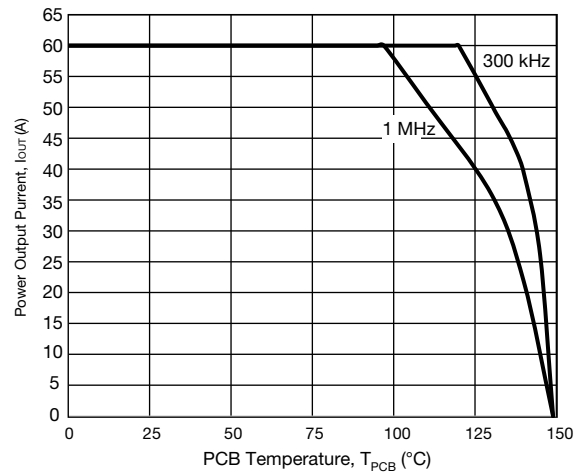
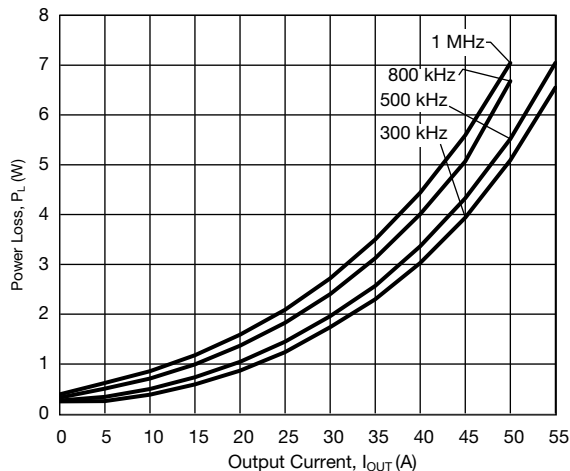
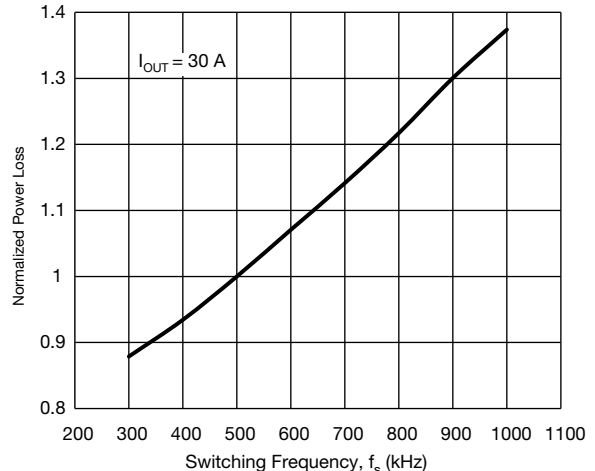
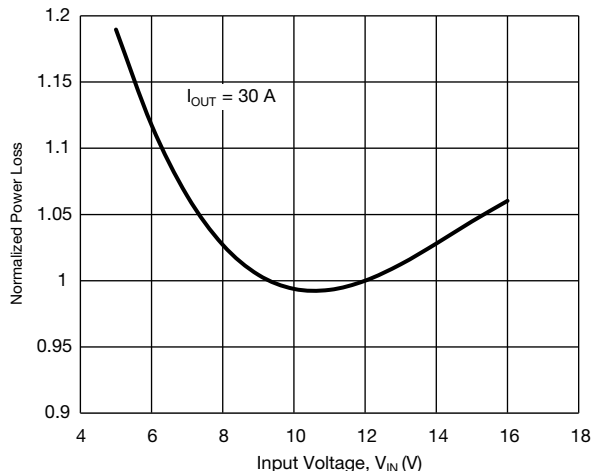
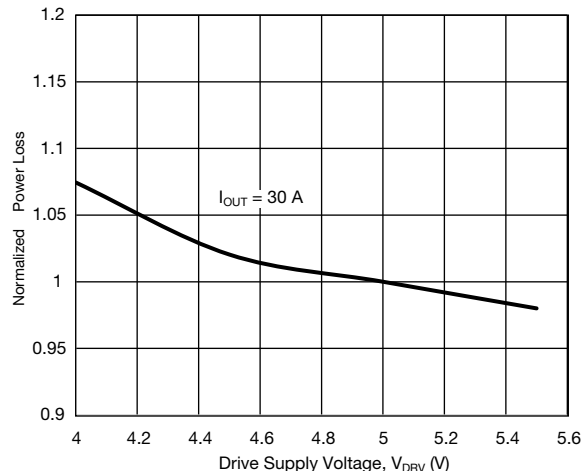

Fig. 5 - ZCD_EN# - PS4 Exit Timing

ELECTRICAL CHARACTERISTICS

Test condition: $V_{IN} = 12\text{ V}$, $V_{DRV} = V_{CIN} = 5\text{ V}$, $ZCD_EN\# = 5\text{ V}$, $V_{OUT} = 1.8\text{ V}$, $L_{OUT} = 250\text{ nH}$ (DCR = $0.32\text{ m}\Omega$), $T_A = 25\text{ }^\circ\text{C}$, natural convection cooling (All power loss and normalized power loss curves show SiC621 losses only unless otherwise stated)

Fig. 6 - Efficiency vs. Output Current

Fig. 9 - Safe Operating Area

Fig. 7 - Power Loss vs. Output Current

Fig. 10 - Power Loss vs. Switching Frequency

Fig. 8 - Power Loss vs. Input Voltage

Fig. 11 - Power Loss vs. Drive Supply Voltage

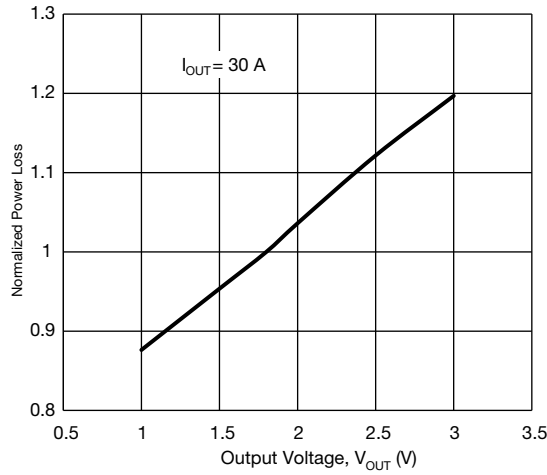

Fig. 12 - Power Loss vs. Output Voltage

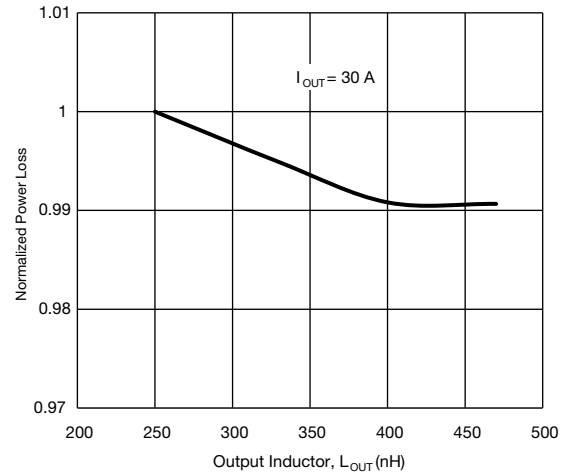

Fig. 15 - Power Loss vs. Output Inductor

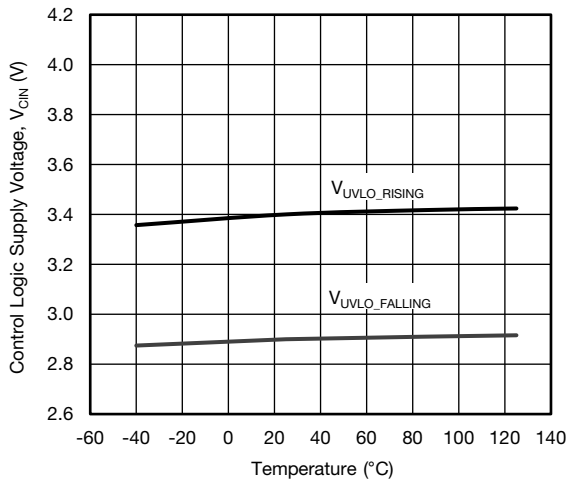

Fig. 13 - UVLO Threshold vs. Temperature

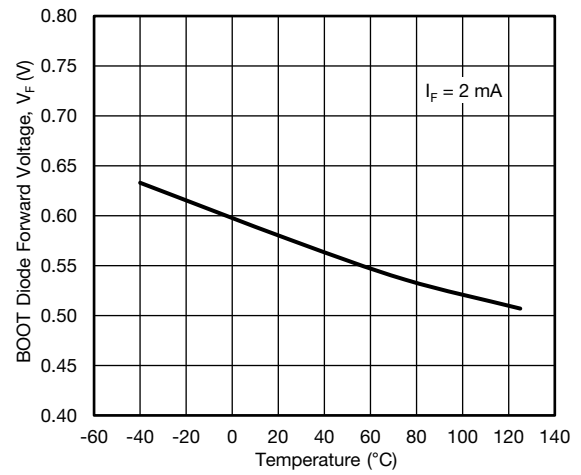

Fig. 16 - BOOT Diode Forward Voltage vs. Temperature

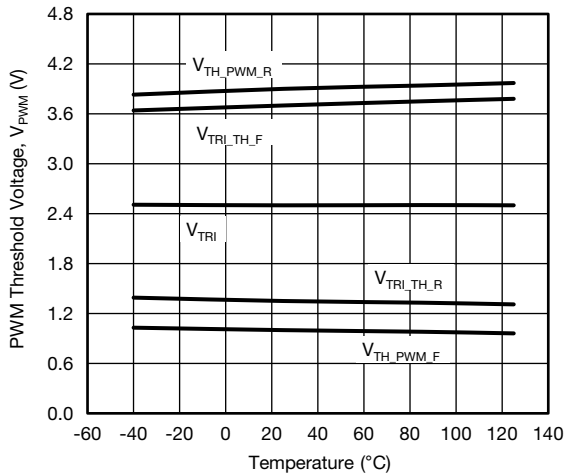

Fig. 14 - PWM Threshold vs. Temperature

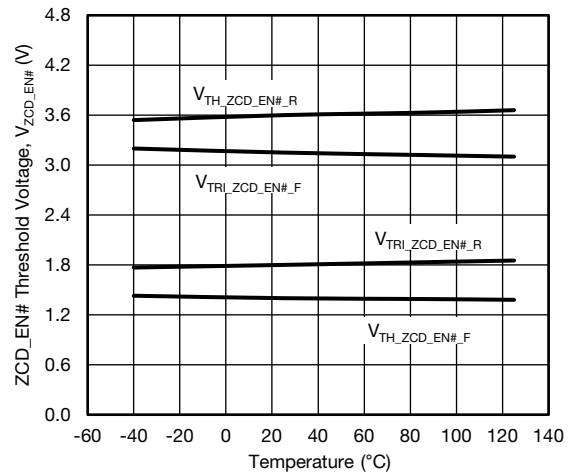

Fig. 17 - ZCD_EN# Threshold vs. Temperature

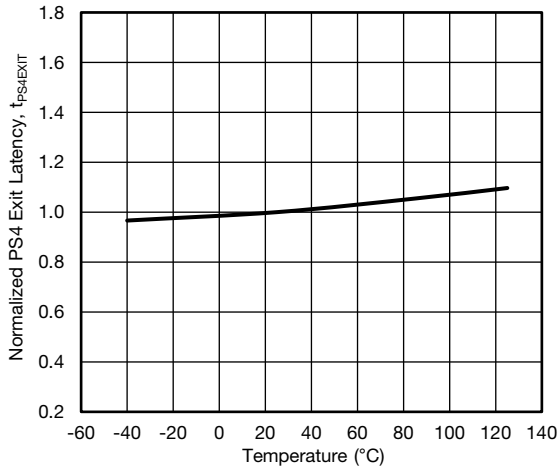

Fig. 18 - PS4 Exit Latency vs. Temperature

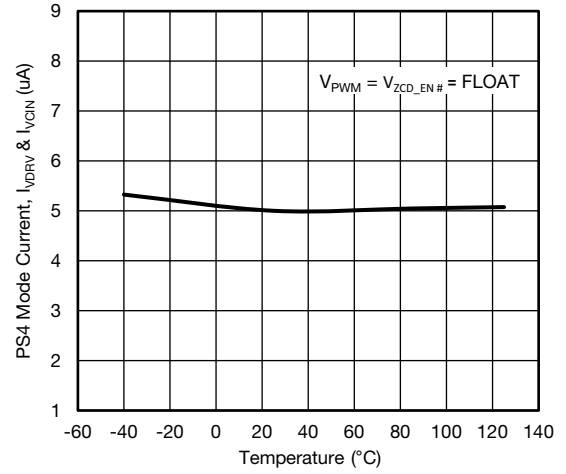
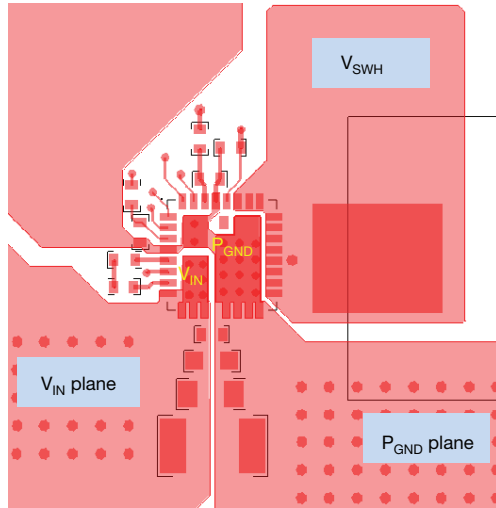
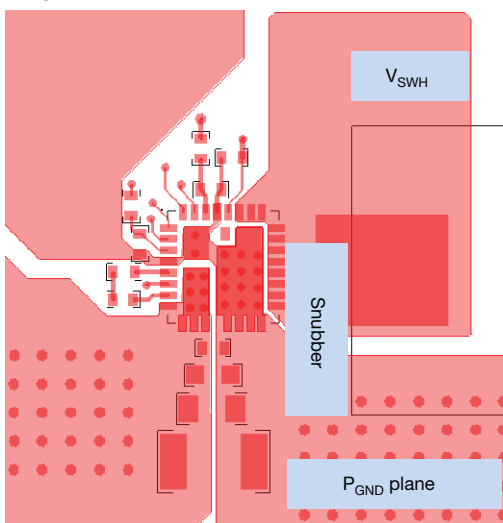

Fig. 19 - PS4 Mode Current vs. Temperature

PCB LAYOUT RECOMMENDATIONS
Step 1: V_{IN} /GND Planes and Decoupling

1. Layout V_{IN} and P_{GND} planes as shown above
2. Ceramic capacitors should be placed directly between V_{IN} and P_{GND} , and close to the device for best decoupling effect
3. Different values / packages of ceramic capacitors should be used to cover entire decoupling spectrum e.g. 1210, 0805, 0603 and 0402
4. Smaller capacitance values, closer to device V_{IN} pin(s), - results in better high frequency noise absorbing

Step 2: V_{SWH} Plane

1. Connect output inductor to DrMOS with large plane to lower resistance
2. If a snubber network is required, place the components as shown above, the network can be placed at bottom

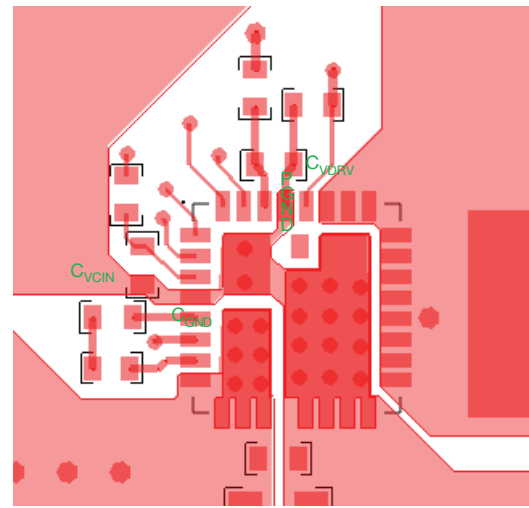
Step 3: V_{CIN} / V_{DRV} Input Filter

1. The V_{CIN} / V_{DRV} input filter ceramic capacitors should be placed close to IC. It is recommended to connect two caps separately
2. V_{CIN} capacitor should be placed between pin 3 (V_{CIN}) and pin 4 (C_{GND} of driver IC) to achieve best noise filtering
3. V_{DRV} capacitor should be placed between pin 28 (P_{GND} of driver IC) and pin 29 (V_{DRV}) to provide maximum instantaneous driver current for low-side MOSFET during switching cycle
4. It is recommended to use a large plane analog ground, C_{GND} , plane to reduce parasitic inductance

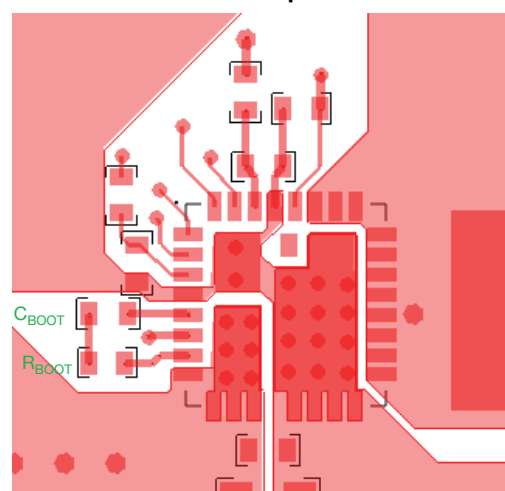
Step 4: BOOT Resistor and Capacitor Placement

1. The components should be placed close to IC, directly between PHASE (pin 7) and BOOT (pin 5)
2. To reduce parasitic inductance, chip size 0402 can be used

Step 5: Signal Routing

1. Route the PWM / ZCD_EN# signal traces out of the top left corner, next to DrMOS pin 1
2. PWM is an important signal, both signal and return traces should not cross any power nodes on any layer
3. It is best to “shield” traces from power switching nodes, e.g. V_{SWH} , to improve signal integrity
4. GL (pin 27) has been connected with GL pad internally and does not need to connect externally

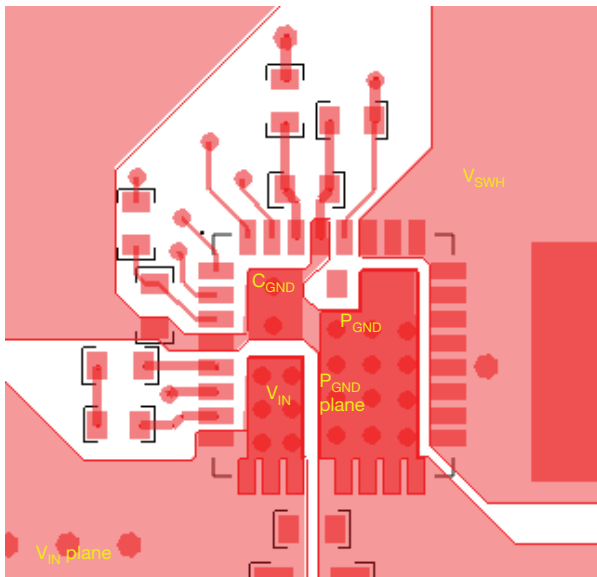
Step 6: Adding Thermal Relief Vias

1. Thermal relief vias can be added on the V_{IN} and P_{GND} pads to utilize inner layers for high-current and thermal dissipation
2. To achieve better thermal performance, additional vias can be added to V_{IN} and P_{GND} planes
3. V_{SWH} pad is a noise source and not recommended to put vias on this plane
4. 8 mil vias for pads and 10 mils vias for planes are the optimal via sizes. Vias on pads may drain solder during assembly and cause assembly issue. Please consult with the assembly house for guideline

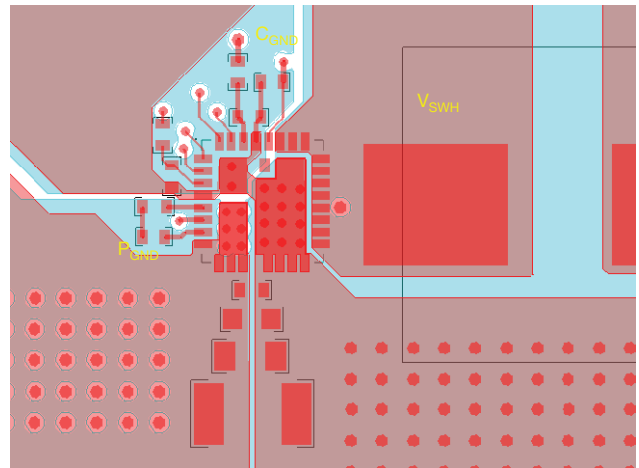
Step 7: Ground Connection

1. It is recommended to make a single connection between C_{GND} and P_{GND} , this connection can be done on top layer
2. It is recommended to make the entire first inner layer (next to top layer) a ground plane and separate it into C_{GND} and P_{GND} plane
3. These ground planes provide shielding between noise sources on top layer and signal traces on bottom layer

Multi-Phases VRPower PCB Layout

The following is an example of 6 phase layout. As can be seen, all the VRPower stages are lined in X-direction compactly with decoupling capacitors next to them. The inductors are placed as close as possible to the SiC621 to minimize the PCB copper loss. Vias are applied on all PADS (V_{IN} , P_{GND} , C_{GND}) of the SiC621 to ensure that both electrical and thermal performance are optimized. Large copper planes are used for all high current loops, such as V_{IN} , V_{SWH} , V_{OUT} and P_{GND} . These copper planes are duplicated in other layers to minimize the inductance and resistance. All the control signals are routed from the SiC621 to a controller placed to the north of the power stage through inner layers to avoid the overlap of high current loops. This achieves a compact design with the output from the inductors feeding a load located to the south of the design as shown in the figure.

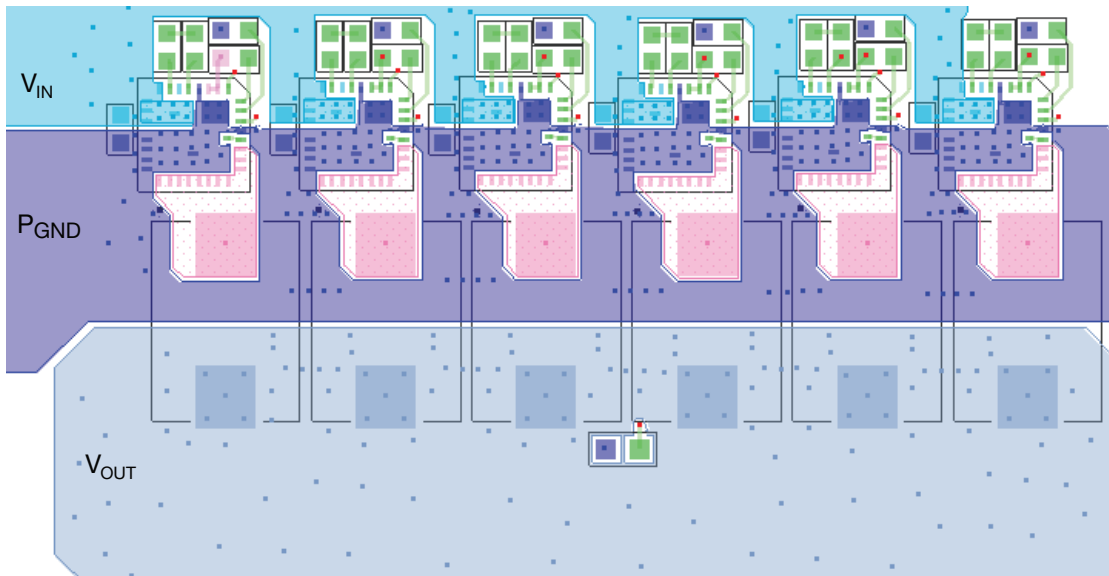
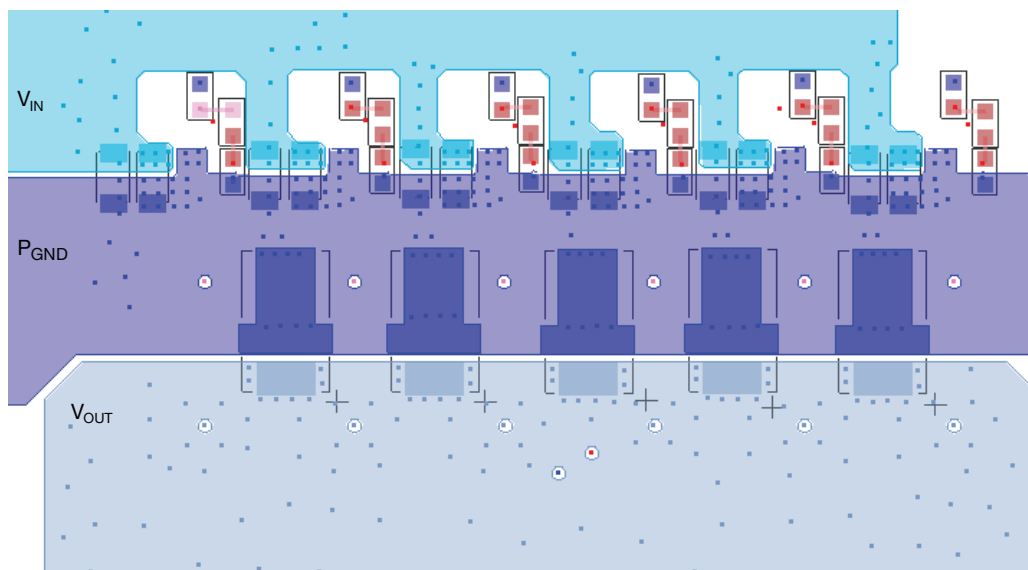
Fig. 20 - Multi-Phase VRPower Layout Top View

Fig. 21 - Multi-Phase VRPower Layout Bottom View



PRODUCT SUMMARY	
Part number	SiC621
Description	60 A power stage, 4.5 V _{IN} to 18 V _{IN} , 5 V PWM with ZCD, PS4 mode
Input voltage min. (V)	4.5
Input voltage max. (V)	18
Continuous current rating max. (A)	60
Switch frequency max. (kHz)	2000
Enable (yes / no)	No
Monitoring features	-
Protection	UVLO, THDN
Light load mode	ZCD, PS4
Pulse-width modulation (V)	5
Package type	PowerPAK MLP55-31L
Package size (W, L, H) (mm)	5.0 x 5.0 x 0.75
Status code	2
Product type	VRPower (DrMOS)
Applications	Computer, industrial, networking

Vishay Siliconix maintains worldwide manufacturing capability. Products may be manufactured at one of several qualified locations. Reliability data for Silicon Technology and Package Reliability represent a composite of all qualified locations. For related documents such as package / tape drawings, part marking, and reliability data, see www.vishay.com/ppg?267173.

PowerPAK® MLP55-31L Case Outline

DIM.	MILLIMETERS			INCHES		
	MIN.	NOM.	MAX.	MIN.	NOM.	MAX.
A	0.70	0.75	0.80	0.027	0.029	0.031
A1	0.00	-	0.05	0.000	-	0.002
A2	0.20 ref.			0.008 ref.		
b	0.20	0.25	0.30	0.078	0.098	0.011
b1	0.15	0.20	0.25	0.006	0.008	0.010
D	4.90	5.00	5.10	0.193	0.196	0.200
e	0.50 BSC			0.019 BSC		
e1	3.50 BSC			0.138 BSC		
e2	1.50 BSC			0.060 BSC		
e3	1.00 BSC			0.040 BSC		
E	4.90	5.00	5.10	0.193	0.196	0.200
L	0.35	0.40	0.45	0.013	0.015	0.017
D2-1	0.98	1.03	1.08	0.039	0.041	0.043
D2-2	0.98	1.03	1.08	0.039	0.041	0.043
D2-3	1.87	1.92	1.97	0.074	0.076	0.078
D2-4	0.30 BSC			0.012 BSC		
D2-5	1.05	1.10	1.15	0.041	0.043	0.045
E2-1	1.27	1.32	1.37	0.050	0.052	0.054
E2-2	1.93	1.98	2.03	0.076	0.078	0.080
E2-3	3.75	3.80	3.85	0.148	0.150	0.152
E2-4	0.45 BSC			0.018 BSC		
F1	0.15	0.20	0.25	0.006	0.008	0.010
F2	0.20 ref.			0.008 ref.		
F3	0.15 ref.			0.006 ref.		



DIM.	MILLIMETERS			INCHES		
	MIN.	NOM.	MAX.	MIN.	NOM.	MAX.
K1		0.67 BSC			0.026 BSC	
K2		0.22 BSC			0.008 BSC	
K3		1.25 BSC			0.049 BSC	
K4		0.10 BSC			0.004 BSC	
K5		0.38 BSC			0.015 BSC	
K6		0.12 BSC			0.005 BSC	
K7		0.40 BSC			0.016 BSC	
K8		0.40 BSC			0.016 BSC	
K9		0.40 BSC			0.016 BSC	
K10		0.85 BSC			0.033 BSC	
K11		0.40 BSC			0.016 BSC	
K12		0.40 BSC			0.016 BSC	
K13		0.75 BSC			0.030 BSC	
ECN: T17-0423-Rev. F, 21-Aug-17 DWG: 6025						

Notes

1. Use millimeters as the primary measurement
2. Dimensioning and tolerances conform to ASME Y14.5M. - 1994
3. Dimension b applies to plated terminal and is measured between 0.20 mm and 0.25 mm from terminal tip
4. The pin #1 identifier must be existed on the top surface of the package by using indentation mark or other feature of package body
5. Exact shape and size of this feature is optional
6. Package warpage max. 0.08 mm
7. Applied only for terminals



Disclaimer

ALL PRODUCT, PRODUCT SPECIFICATIONS AND DATA ARE SUBJECT TO CHANGE WITHOUT NOTICE TO IMPROVE RELIABILITY, FUNCTION OR DESIGN OR OTHERWISE.

Vishay Intertechnology, Inc., its affiliates, agents, and employees, and all persons acting on its or their behalf (collectively, "Vishay"), disclaim any and all liability for any errors, inaccuracies or incompleteness contained in any datasheet or in any other disclosure relating to any product.

Vishay makes no warranty, representation or guarantee regarding the suitability of the products for any particular purpose or the continuing production of any product. To the maximum extent permitted by applicable law, Vishay disclaims (i) any and all liability arising out of the application or use of any product, (ii) any and all liability, including without limitation special, consequential or incidental damages, and (iii) any and all implied warranties, including warranties of fitness for particular purpose, non-infringement and merchantability.

Statements regarding the suitability of products for certain types of applications are based on Vishay's knowledge of typical requirements that are often placed on Vishay products in generic applications. Such statements are not binding statements about the suitability of products for a particular application. It is the customer's responsibility to validate that a particular product with the properties described in the product specification is suitable for use in a particular application. Parameters provided in datasheets and / or specifications may vary in different applications and performance may vary over time. All operating parameters, including typical parameters, must be validated for each customer application by the customer's technical experts. Product specifications do not expand or otherwise modify Vishay's terms and conditions of purchase, including but not limited to the warranty expressed therein.

Hyperlinks included in this datasheet may direct users to third-party websites. These links are provided as a convenience and for informational purposes only. Inclusion of these hyperlinks does not constitute an endorsement or an approval by Vishay of any of the products, services or opinions of the corporation, organization or individual associated with the third-party website. Vishay disclaims any and all liability and bears no responsibility for the accuracy, legality or content of the third-party website or for that of subsequent links.

Except as expressly indicated in writing, Vishay products are not designed for use in medical, life-saving, or life-sustaining applications or for any other application in which the failure of the Vishay product could result in personal injury or death. Customers using or selling Vishay products not expressly indicated for use in such applications do so at their own risk. Please contact authorized Vishay personnel to obtain written terms and conditions regarding products designed for such applications.

No license, express or implied, by estoppel or otherwise, to any intellectual property rights is granted by this document or by any conduct of Vishay. Product names and markings noted herein may be trademarks of their respective owners.