

54F/74F378 Parallel D Register with Enable

General Description

The 'F378 is a 6-bit register with a buffered common Enable. This device is similar to the 'F174, but with common Enable rather than common Master Reset.

Features

- 6-bit high-speed parallel register
- Positive edge-triggered D-type inputs
- Fully buffered common clock and enable inputs
- Input clamp diodes limit high-speed termination effects
- Full TTL and CMOS compatible

Commercial	Military	Package Number	Package Description
74F378PC		N16E	16-Lead (0.300" Wide) Molded Dual-In-Line
	54F378DM (QB)	J16A	16-Lead Ceramic Dual-In-Line
74F378SC (Note 1)		M16A	16-Lead (0.150" Wide) Molded Small Outline, JEDEC
74F378SJ (Note 1)		M16D	16-Lead (0.300" Wide) Molded Small Outline, EIAJ
	54F378FM (QB)	W16A	16-Lead Cerpack
	54F378LM (QB)	E20A	20-Lead Ceramic Leadless Chip Carrier, Type C

Note 1: Devices also available in 13" reel. Use suffix = SCX and SJX.

Logic Symbols

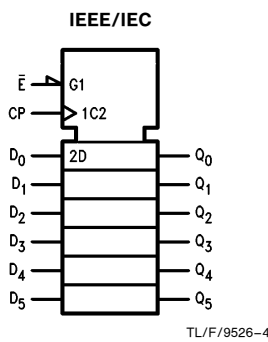
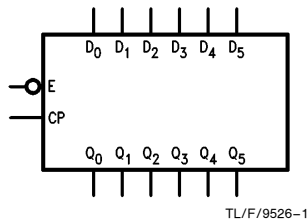

Connection Diagrams

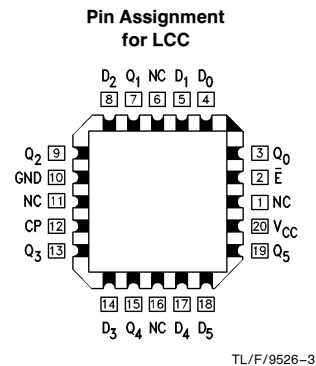
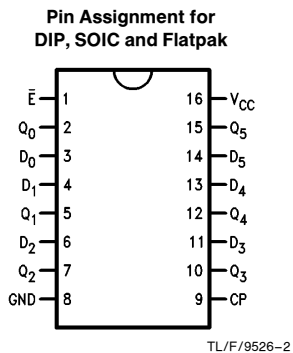

TRI-STATE® is a registered trademark of National Semiconductor Corporation.

Unit Loading/Fan Out

Pin Names	Description	54F/74F	
		U.L. HIGH/LOW	Input I_{IH}/I_{IL} Output I_{OH}/I_{OL}
\bar{E}	Enable Input (Active LOW)	1.0/1.0	20 μ A/ -0.6 mA
D_0 - D_5	Data Inputs	1.0/1.0	20 μ A/ -0.6 mA
CP	Clock Pulse Input (Active Rising Edge)	1.0/1.0	20 μ A/ -0.6 mA
Q_0 - Q_5	Outputs	50/33.3	-1 mA/20 mA

Functional Description

The 'F378 consists of six edge-triggered D-type flip-flops with individual D inputs and Q outputs. The Clock (CP) and Enable (\bar{E}) inputs are common to all flip-flops.

When the \bar{E} input is LOW, new data is entered into the register on the LOW-to-HIGH transition of the CP input. When the \bar{E} input is HIGH the register will retain the present data independent of the CP input.

Truth Table

Inputs			Output
\bar{E}	CP	D_n	Q_n
H	—	X	No Change
L	↗	H	H
L	↗	L	L

H = HIGH Voltage Level
 L = LOW Voltage Level
 X = Immaterial
 ↗ = LOW-to-HIGH Clock Transition

Logic Diagram

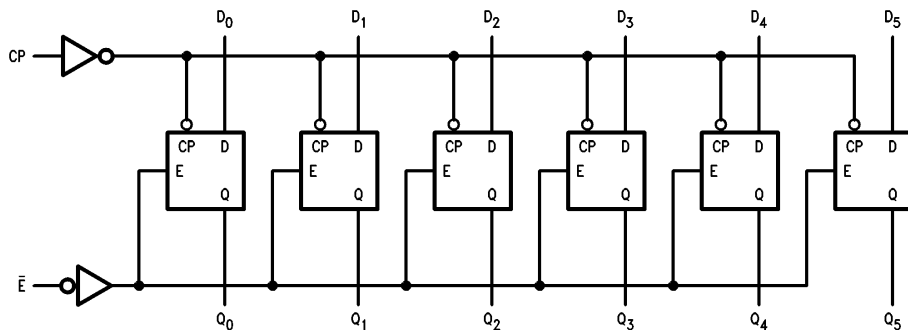

TL/F/9526-5

Please note that this diagram is provided only for the understanding of logic operations and should not be used to estimate propagation delays.

Absolute Maximum Ratings (Note 1)

If Military/Aerospace specified devices are required, please contact the National Semiconductor Sales Office/Distributors for availability and specifications.

Storage Temperature	-65°C to +150°C
Ambient Temperature under Bias	-55°C to +125°C
Junction Temperature under Bias	-55°C to +175°C
Plastic	-55°C to +150°C
V _{CC} Pin Potential to Ground Pin	-0.5V to +7.0V
Input Voltage (Note 2)	-0.5V to +7.0V
Input Current (Note 2)	-30 mA to +5.0 mA
Voltage Applied to Output in HIGH State (with V _{CC} = 0V)	
Standard Output	-0.5V to V _{CC}
TRI-STATE® Output	-0.5V to +5.5V

Current Applied to Output in LOW State (Max) twice the rated I_{OL} (mA)

Note 1: Absolute maximum ratings are values beyond which the device may be damaged or have its useful life impaired. Functional operation under these conditions is not implied.

Note 2: Either voltage limit or current limit is sufficient to protect inputs.

Recommended Operating Conditions

Free Air Ambient Temperature	
Military	-55°C to +125°C
Commercial	0°C to +70°C
Supply Voltage	
Military	+4.5V to +5.5V
Commercial	+4.5V to +5.5V

DC Electrical Characteristics

Symbol	Parameter	54F/74F			Units	V _{CC}	Conditions
		Min	Typ	Max			
V _{IH}	Input HIGH Voltage	2.0			V		Recognized as a HIGH Signal
V _{IL}	Input LOW Voltage			0.8	V		Recognized as a LOW Signal
V _{CD}	Input Clamp Diode Voltage			-1.2	V	Min	I _{IN} = -18 mA
V _{OH}	Output HIGH Voltage	54F 10% V _{CC} 74F 10% V _{CC} 74F 5% V _{CC}		2.5 2.5 2.7	V	Min	I _{OH} = -1 mA I _{OH} = -1 mA I _{OH} = -1 mA
V _{OL}	Output LOW Voltage	54F 10% V _{CC} 74F 10% V _{CC}		0.5 0.5	V	Min	I _{OL} = 20 mA I _{OL} = 20 mA
I _{IH}	Input HIGH Current	54F 74F		20.0 5.0	μA	Max	V _{IN} = 2.7V
I _{BVI}	Input HIGH Current Breakdown Test	54F 74F		100 7.0	μA	Max	V _{IN} = 7.0V
I _{CEX}	Output HIGH Leakage Current	54F 74F		250 50	μA	Max	V _{OUT} = V _{CC}
V _{ID}	Input Leakage Test	74F	4.75		V	0.0	I _{ID} = 1.9 μA All Other Pins Grounded
I _{OD}	Output Leakage Circuit Current	74F		3.75	μA	0.0	V _{IOD} = 150 mV All Other Pins Grounded
I _{IL}	Input LOW Current			-0.6	mA	Max	V _{IN} = 0.5V
I _{OS}	Output Short-Circuit Current			-60	mA	Max	V _{OUT} = 0V
I _{CCL}	Power Supply Current		30	45	mA	Max	V _O = LOW

AC Electrical Characteristics

Symbol	Parameter	74F			54F		74F		Units
		T _A = +25°C V _{CC} = +5.0V C _L = 50 pF			T _A , V _{CC} = Mil C _L = 50 pF		T _A , V _{CC} = Com C _L = 50 pF		
		Min	Typ	Max	Min	Max	Min	Max	
f _{max}	Maximum Input Frequency	80	100		70		80		MHz
t _{PLH}	Propagation Delay	3.0	5.5	7.5	3.0	10.0	3.0	8.5	ns
t _{PHL}	CP to Q _n	3.5	6.0	8.5	3.5	10.5	3.5	9.5	

AC Operating Requirements

Symbol	Parameter	74F		54F		74F		Units
		T _A = +25°C V _{CC} = +5.0V		T _A , V _{CC} = Mil		T _A , V _{CC} = Com		
		Min	Max	Min	Max	Min	Max	
t _s (H)	Setup Time, HIGH or LOW	4.0		5.0		4.0		ns
t _s (L)	D _n to CP	4.0		5.0		4.0		
t _h (H)	Hold Time, HIGH or LOW	0		2.0		0		ns
t _h (L)	D _n to CP	0		2.0		0		
t _s (H)	Setup Time, HIGH or LOW	6.0		4.5		6.0		ns
t _s (L)	E to CP	10.0		13.0		10.0		
t _h (H)	Hold Time, HIGH or LOW	0		0		0		ns
t _h (L)	E to CP	0		0		0		
t _w (H)	CP Pulse Width	4.0		5.0		4.0		ns
t _w (L)	HIGH or LOW	6.0		7.5		6.0		

Ordering Information

The device number is used to form part of a simplified purchasing code where the package type and temperature range are defined as follows:

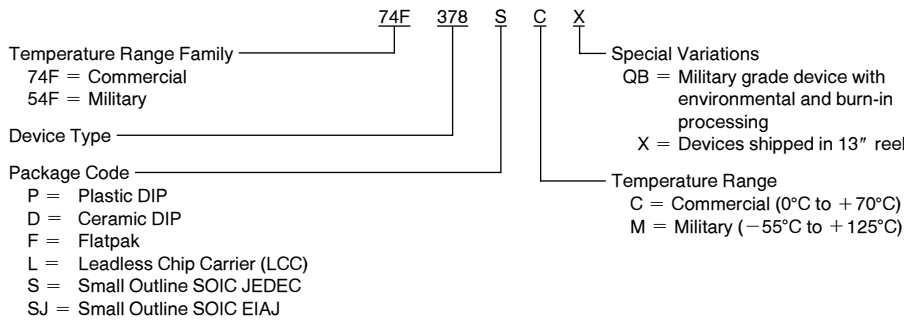

Physical Dimensions inches (millimeters)

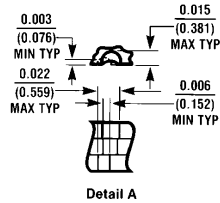
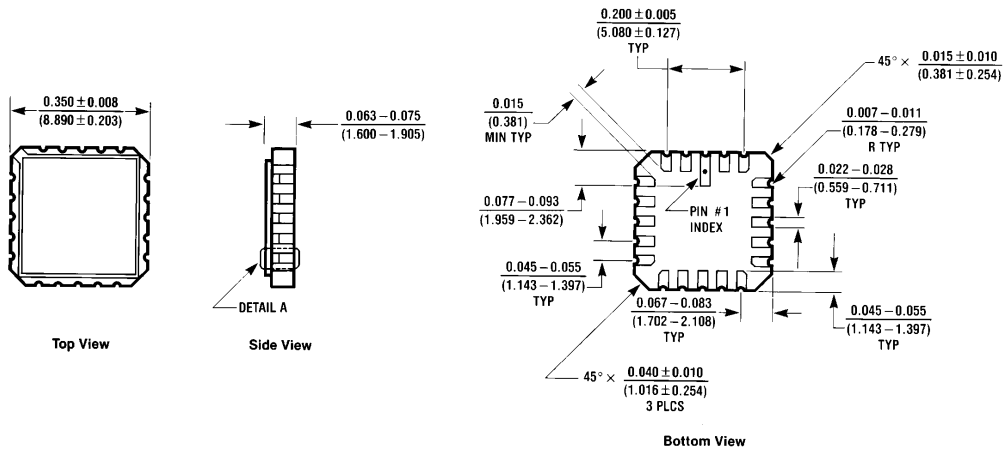

20-Lead Ceramic Leadless Chip Carrier (L)
NS Package Number E20A

E20A (REV D)

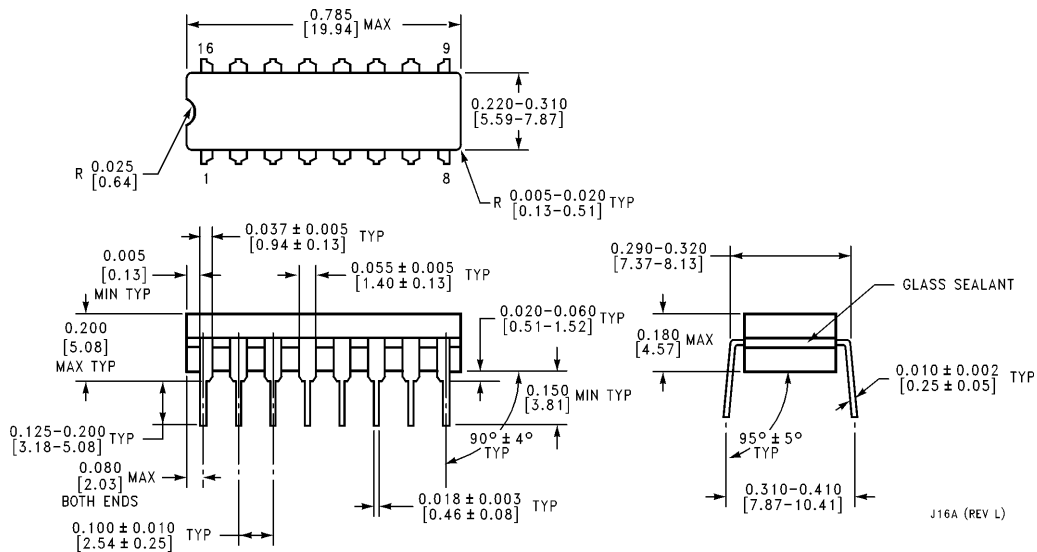

16-Lead Ceramic Dual-In-Line Package (D)
NS Package Number J16A

J16A (REV L)

Physical Dimensions inches (millimeters) (Continued)

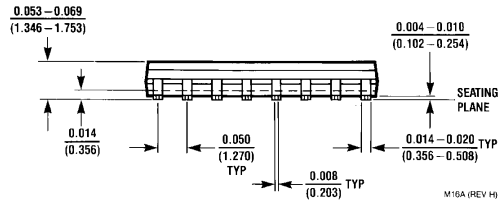
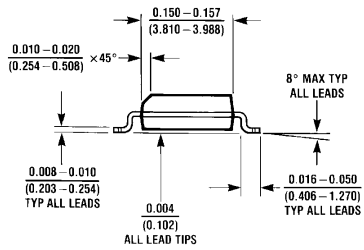
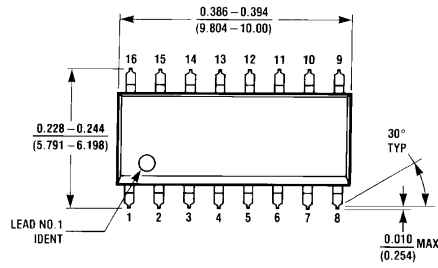

**16-Lead (0.150" Wide) Molded Small Outline Package, JEDEC
NS Package Number M16A**

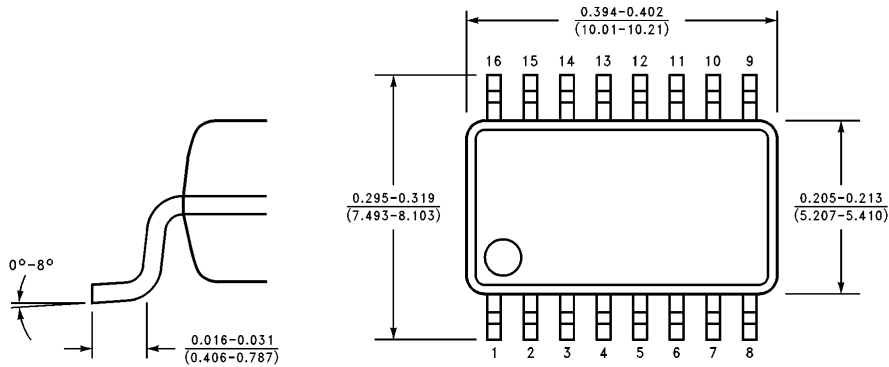

DETAIL F

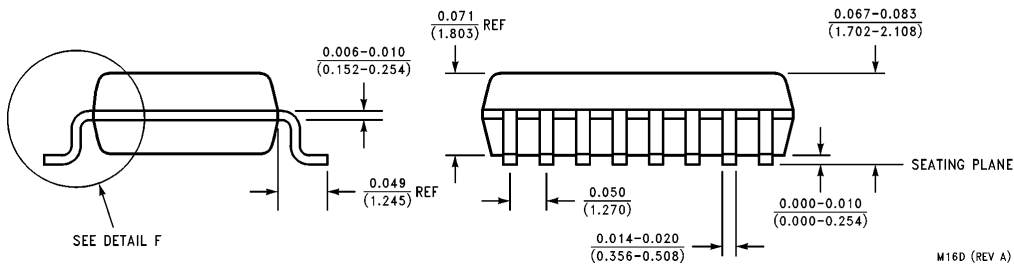

**16-Lead (0.300" Wide) Molded Small Outline Package, EIAJ (SJ)
NS Package Number M16D**

Physical Dimensions inches (millimeters) (Continued)

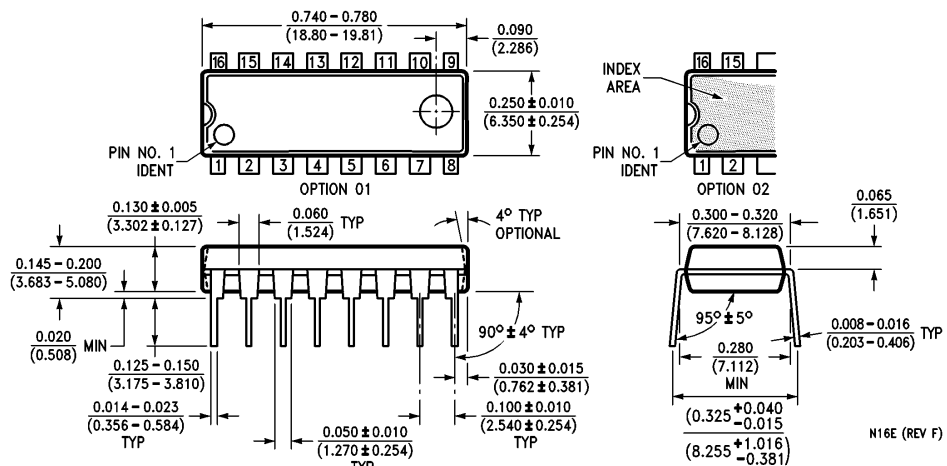

16-Lead (0.300" Wide) Molded Dual-In-Line Package (P)
NS Package Number N16E

N16E (REV F)

Physical Dimensions inches (millimeters) (Continued)

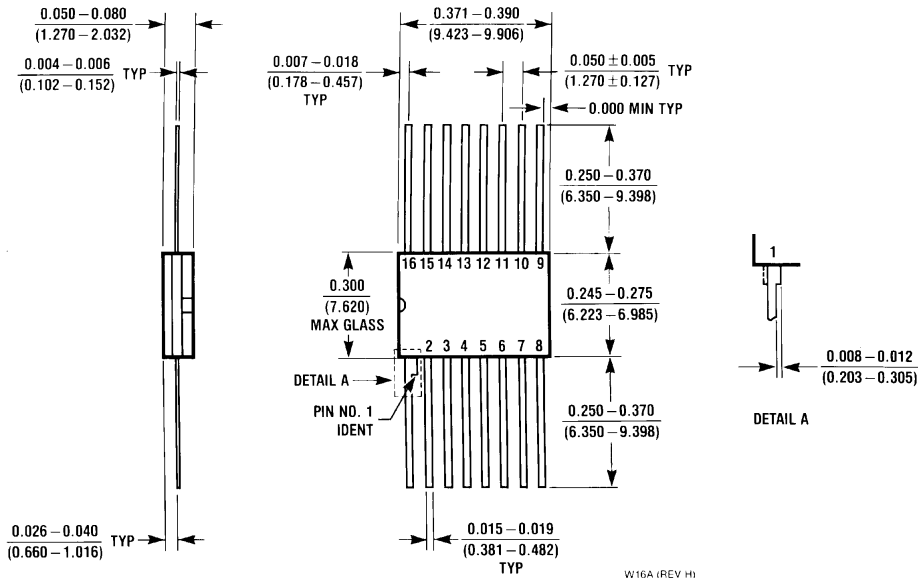

**16-Lead Ceramic Flatpak (F)
NS Package Number W16A**

LIFE SUPPORT POLICY

NATIONAL'S PRODUCTS ARE NOT AUTHORIZED FOR USE AS CRITICAL COMPONENTS IN LIFE SUPPORT DEVICES OR SYSTEMS WITHOUT THE EXPRESS WRITTEN APPROVAL OF THE PRESIDENT OF NATIONAL SEMICONDUCTOR CORPORATION. As used herein:

1. Life support devices or systems are devices or systems which, (a) are intended for surgical implant into the body, or (b) support or sustain life, and whose failure to perform, when properly used in accordance with instructions for use provided in the labeling, can be reasonably expected to result in a significant injury to the user.
2. A critical component is any component of a life support device or system whose failure to perform can be reasonably expected to cause the failure of the life support device or system, or to affect its safety or effectiveness.



National Semiconductor Corporation
2900 Semiconductor Drive
P.O. Box 58090
Santa Clara, CA 95052-8090
Tel: (1800) 272-9959
TWX: (910) 339-9240

National Semiconductor GmbH
Livry-Gargan-Str. 10
D-82256 Fürstenfeldbruck
Germany
Tel: (81-41) 35-0
Telex: 527849
Fax: (81-41) 35-1

National Semiconductor Japan Ltd.
Sumitomo Chemical
Engineering Center
Bldg. 7F
1-7-1, Nakase, Mihama-Ku
Chiba-City,
Ciba Prefecture 261
Tel: (043) 299-2300
Fax: (043) 299-2500

National Semiconductor Hong Kong Ltd.
13th Floor, Straight Block,
Ocean Centre, 5 Canton Rd.
Tsimshatsui, Kowloon
Hong Kong
Tel: (852) 2737-1600
Fax: (852) 2736-9960

National Semicondutores Do Brazil Ltda.
Rue Deputado Lacorda Franco
120-3A
Sao Paulo-SP
Brazil 05418-000
Tel: (55-11) 212-5066
Telex: 391-1131931 NSBR BR
Fax: (55-11) 212-1181

National Semiconductor (Australia) Pty. Ltd.
Building 16
Business Park Drive
Monash Business Park
Nottingham, Melbourne
Victoria 3168 Australia
Tel: (3) 558-9999
Fax: (3) 558-9998

National does not assume any responsibility for use of any circuitry described, no circuit patent licenses are implied and National reserves the right at any time without notice to change said circuitry and specifications.

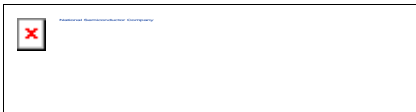

54F378 Parallel D Register with Enable

Contents

- [General Description](#)
- [Features](#)
- [Datasheet](#)
- [Package Availability, Models, Samples & Pricing](#)



General Description

The 'F378 is a 6-bit register with a buffered common Enable. This device is similar to the 'F174, but with common Enable rather than common Master Reset.

Features

- 6-bit high-speed parallel register
 - Positive edge-triggered D-type inputs
 - Fully buffered common clock and enable inputs
 - Input clamp diodes limit high-speed termination effects
 - Full TTL and CMOS compatible
-

Datasheet

Title	Size (in Kbytes)	Date	 View Online	 Download	 Receive via Email
54F378 Parallel D Register with Enable	166 Kbytes	9-Dec-97	View Online	Download	Receive via Email

Please use [Adobe Acrobat](#) to view PDF file(s).
If you have trouble printing, see [Printing Problems](#).

Package Availability, Models, Samples & Pricing

Part Number	Package		Status	Models		Samples & Electronic Orders	Budgetary Pricing		Std Pack Size	Package Marking
	Type	# pins		SPICE	IBIS		Quantity	\$US each		
5962-8855501EA	Cerdip	16	Full production	N/A	N/A		50+	\$6.0000	tube of 25	[logo]çZçSç4çA\$E 54F378DMQB /QçM 5962-8855501EA
5962-8855501FA	Cerpack	16	Full production	N/A	N/A	.	50+	\$6.0000	tube of 19	[logo]çZçSç4çA\$E 54F378FMQB QçM 5962- 8855501FA

[Information as of 1-Sep-2000]

Quick Search

[Parametric Search](#)

[System Diagrams](#)

[Product Tree](#)

[Home](#)

[About Languages](#) . [About the Site](#) . [About "Cookies"](#)

National is [QS 9000 Certified](#) . [Privacy/Security](#)

[Copyright](#) © National Semiconductor Corporation

[Preferences](#) . [Feedback](#)