



MOTOROLA

8-BIT ADDRESSABLE LATCH

The MC54/74F259 is a high-speed 8-bit addressable latch designed for general purpose storage applications in digital systems. It is a multifunctional device capable of storing single line data in eight addressable latches, and also a 1-of-8 decoder and demultiplexer with active HIGH outputs. The device also incorporates an active LOW Common Clear for resetting all latches, as well as an active LOW Enable.

- Serial-to-Parallel Conversion
- Eight Bits of Storage with Output of Each Bit Available
- Random (Addressable) Data Entry
- Active High Demultiplexing or Decoding Capability
- Easily Expandable
- Common Clear

FUNCTIONAL DESCRIPTION

The MC54/74F259 has four modes of operation as shown in the Mode Select Table. In the addressable latch mode, data on the Data line (D) is written into the addressed latch. The addressed latch will follow the data input with all non-addressed latches remaining in their previous states in the memory mode. All the latches remain in their previous state and are unaffected by the Data or Address inputs.

In the one-of-eight decoding or demultiplexing mode, the addressed output will follow the state of the D input with all other outputs in the LOW state. In the clear mode all outputs are LOW and unaffected by the address and data inputs. When operating the MC54/74F259 as an addressable latch, changing more than one bit of the address could impose a transient wrong address. Therefore, this should only be done while in the memory mode. The Truth Table below summarizes the operations of the MC54/74F259.

CONNECTION DIAGRAM

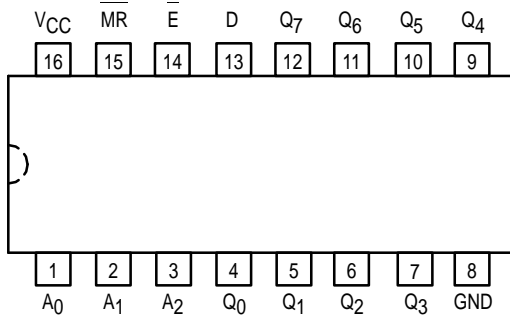

MC54/74F259

8-BIT ADDRESSABLE LATCH
FAST™ SCHOTTKY TTL

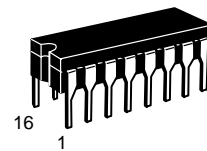

J SUFFIX
CERAMIC
CASE 620-09

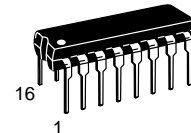

N SUFFIX
PLASTIC
CASE 648-08

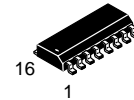

D SUFFIX
SOIC
CASE 751B-03

ORDERING INFORMATION

MC54FXXXJ	Ceramic
MC74FXXXN	Plastic
MC74FXXXD	SOIC

LOGIC SYMBOL

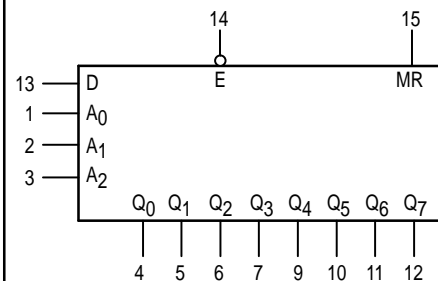

LIFETIME BUY

LAST SHIP 30/09/99
LAST ORDER 31/03/99

MC54/74F259

GUARANTEED OPERATING RANGES

Symbol	Parameter		Min	Typ	Max	Unit
V _{CC}	Supply Voltage	54, 74	4.5	5.0	5.5	V
T _A	Operating Ambient Temperature Range	54	-55	25	125	°C
		74	0	25	70	
I _{OH}	Output Current — High	54, 74			-1.0	mA
I _{OL}	Output Current — Low	54, 74			20	mA

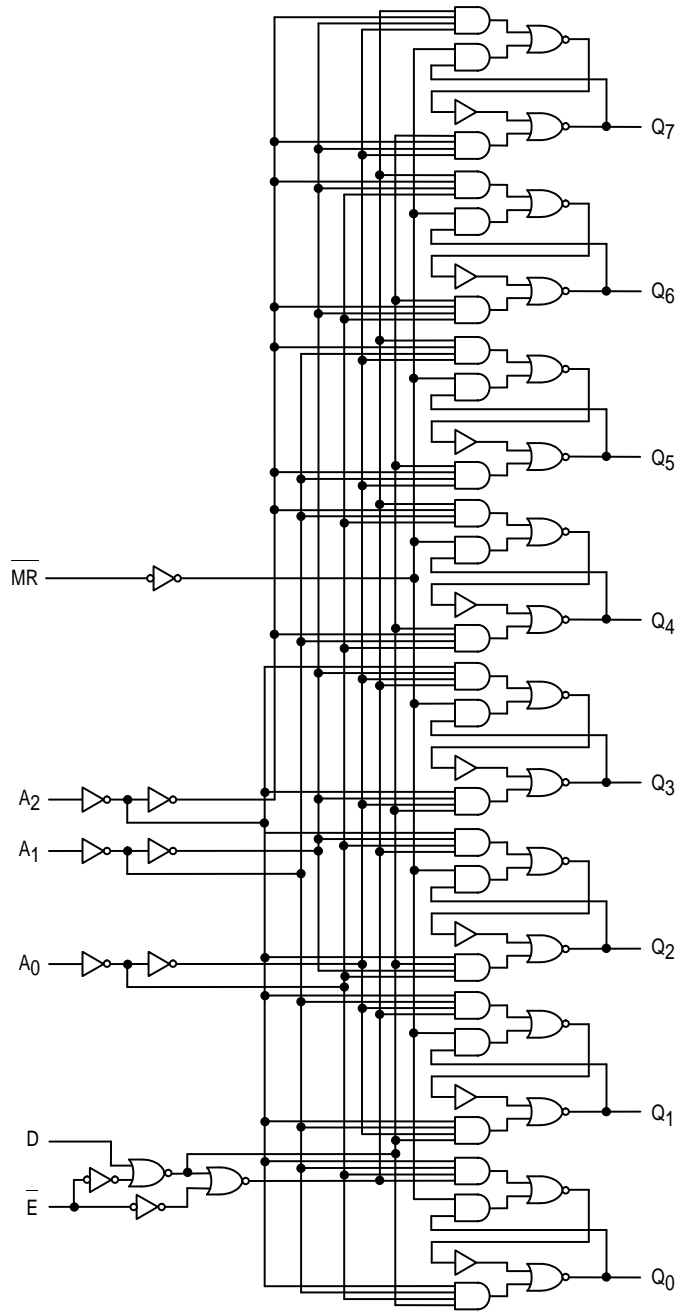

Please note that this diagram is provided only for the understanding of logic operations and should not be used to estimate propagation delays.

LIFETIME BUY

LAST SHIP 30/09/99
LAST ORDER 31/03/99

MC54/74F259

MODE SELECT TABLE

E	MR	Mode
L	H	Addressable Latch
H	H	Memory
L	L	Active HIGH 8-Channel Demultiplexer
H	L	Clear

H = HIGH Voltage Level
L = LOW Voltage Level

FUNCTION TABLE

Operating Mode	Inputs						Outputs							
	MR	E	D	A ₀	A ₁	A ₂	Q ₀	Q ₁	Q ₂	Q ₃	Q ₄	Q ₅	Q ₆	Q ₇
Master Reset	L	H	X	X	X	X	L	L	L	L	L	L	L	L
Demultiplex (Active HIGH Decoder when D = H)	L	L	d	L	L	L	Q=d	L	L	L	L	L	L	L
	L	L	d	H	L	L	L	Q=d	L	L	L	L	L	L
	L	L	d	L	H	L	L	L	Q=d	L	L	L	L	L
	•	•	•	•	•	•	•	•	•	•	•	•	•	•
	L	L	d	H	H	H	L	L	L	L	L	L	L	Q=d
Store (Do Nothing)	H	H	X	X	X	X	q ₀	q ₁	q ₂	q ₃	q ₄	q ₅	q ₆	q ₇
Addressable Latch	H	L	d	L	L	L	Q=d	q ₁	q ₂	q ₃	q ₄	q ₅	q ₆	q ₇
	H	L	d	H	L	L	q ₀	Q=d	q ₂	q ₃	q ₄	q ₅	q ₆	q ₇
	H	L	d	L	H	L	q ₀	q ₁	Q=d	q ₃	q ₄	q ₅	q ₆	q ₇
	•	•	•	•	•	•	•	•	•	•	•	•	•	•
	•	•	•	•	•	•	•	•	•	•	•	•	•	•
	H	L	d	H	H	H	q ₀	q ₁	q ₂	q ₃	q ₄	q ₅	q ₆	Q=d

H = HIGH Voltage Level
L = LOW Voltage Level
X = Immaterial

d = HIGH or LOW Data one setup time prior to the LOW-to-HIGH Enable transition.

q = Lower case letters indicate the state of the referenced output established during the last cycle in which it was addressed or cleared.

LIFETIME BUY

LAST SHIP 30/09/99
LAST ORDER 31/03/99

MC54/74F259

DC CHARACTERISTICS OVER OPERATING TEMPERATURE RANGE (unless otherwise specified)

Symbol	Parameter	Limits			Unit	Test Conditions
		Min	Typ	Max		
V _{IH}	Input HIGH Voltage	2.0			V	Guaranteed Input HIGH Voltage
V _{IL}	Input LOW Voltage			0.8	V	Guaranteed Input LOW Voltage
V _{IK}	Input Clamp Diode Voltage			-1.2	V	V _{CC} = MIN, I _{IN} = -18 mA
V _{OH}	Output HIGH Voltage	54, 74	2.5		V	I _{OL} = -1.0 mA, V _{CC} = MIN
		74	2.7		V	I _{OL} = -1.0 mA, V _{CC} = 4.75 V
V _{OL}	Output LOW Voltage			0.5	V	I _{OL} = 20 mA, V _{CC} = MIN
I _{IH}	Input HIGH Current			20	μA	V _{CC} = MAX, V _{IN} = 2.7 V
				0.1	mA	V _{CC} = MAX, V _{IN} = 7.0 V
I _{IL}	Input LOW Current			-0.6	mA	V _{CC} = MAX, V _{IN} = 0.5 V
I _{OS}	Output Short Circuit Current (Note 2)	-60		-150	mA	V _{CC} = MAX, V _{OUT} = 0 V
I _{CC}	Power Supply Current Total, Output HIGH Total, Output LOW			46	mA	V _{CC} = MAX
				75	mA	V _{CC} = MAX

NOTES:

1. For conditions shown as MIN or MAX, use the appropriate value specified under recommended operating conditions for the applicable device type.
2. Not more than one output should be shorted at a time, nor for more than 1 second.

AC CHARACTERISTICS

Symbol	Parameter	54/74F		54F		74F		Unit
		T _A = +25°C V _{CC} = +5.0 V C _L = 50 pF		T _A = -55 to + 125°C V _{CC} = 5.0 V ±10% C _L = 50 pF		T _A = 0 to + 70°C V _{CC} = 5.0 V ±10% C _L = 50 pF		
		Min	Max	Min	Max	Min	Max	
t _{PLH} t _{PHL}	Propagation Delay E to Q _n	4.0 3.0	10.5 7.0	4.0 3.0	13 8.5	4.0 3.0	12 7.0	ns
t _{PLH} t _{PHL}	Propagation Delay D _n to Q _n	3.5 3.0	9.0 6.5	3.5 2.5	11.5 8.5	3.5 2.5	10 7.0	ns
t _{PLH} t _{PHL}	Propagation Delay A _n to Q _n	3.5 4.0	13 9.0	3.5 4.0	15.5 11	3.5 4.0	14.5 9.5	ns
t _{PHL}	Propagation Delay MR to Q _n	5.0	9.0	4.5	11.5	4.5	10	ns

LIFETIME BUY

LAST SHIP 30/09/99
LAST ORDER 31/03/99

MC54/74F259

AC OPERATING REQUIREMENTS

Symbol	Parameter	54/74F		54F		74F		Unit
		$T_A = +25^\circ\text{C}$ $V_{CC} = +5.0\text{ V}$		$T_A = -55\text{ to }+125^\circ\text{C}$ $V_{CC} = 5.0 \pm 10\%$		$T_A = 0\text{ to }+70^\circ\text{C}$ $V_{CC} = 5.0\text{ V} \pm 10\%$		
		Min	Max	Min	Max	Min	Max	
$t_s(H)$ $t_s(L)$	Setup Time, HIGH or LOW D _n to E	4.0		5.0		4.0		ns
$t_h(H)$ $t_h(L)$	Hold Time, HIGH or LOW D _n to E	2.0		2.0		2.0		ns
$t_s(H)$ $t_s(L)$	Setup Time, HIGH or LOW A to E(a)	4.0		4.0		4.0		ns
$t_h(H)$ $t_h(L)$	Hold Time, HIGH or LOW A to E(b)	0		0		0		ns
t_W	E Pulse Width	4.0		4.0		4.0		ns
t_W	MR Pulse Width	4.0		4.0		4.0		ns

- a. The Address to Enable setup time is the time before the HIGH-to-LOW Enable transition that the Address must be stable so that the correct latch is addressed and the other latches are not affected.
- b. The Address to Enable hold time is the time after the LOW-to-HIGH Enable transition that the Address must be stable so that the correct latch is addressed and the other latches are not affected.

LIFETIME BUY

LAST SHIP 30/09/99
LAST ORDER 31/03/99

LIFETIME BUY

LAST ORDER 31/03/99 LAST SHIP 30/09/99

Mfax is a trademark of Motorola, Inc.

Motorola reserves the right to make changes without further notice to any products herein. Motorola makes no warranty, representation or guarantee regarding the suitability of its products for any particular purpose, nor does Motorola assume any liability arising out of the application or use of any product or circuit, and specifically disclaims any and all liability, including without limitation consequential or incidental damages. "Typical" parameters which may be provided in Motorola data sheets and/or specifications can and do vary in different applications and actual performance may vary over time. All operating parameters, including "Typicals" must be validated for each customer application by customer's technical experts. Motorola does not convey any license under its patent rights nor the rights of others. Motorola products are not designed, intended, or authorized for use as components in systems intended for surgical implant into the body, or other applications intended to support or sustain life, or for any other application in which the failure of the Motorola product could create a situation where personal injury or death may occur. Should Buyer purchase or use Motorola products for any such unintended or unauthorized application, Buyer shall indemnify and hold Motorola and its officers, employees, subsidiaries, affiliates, and distributors harmless against all claims, costs, damages, and expenses, and reasonable attorney fees arising out of, directly or indirectly, any claim of personal injury or death associated with such unintended or unauthorized use, even if such claim alleges that Motorola was negligent regarding the design or manufacture of the part. Motorola and  are registered trademarks of Motorola, Inc. Motorola, Inc. is an Equal Opportunity/Affirmative Action Employer.

How to reach us:

USA/EUROPE/Locations Not Listed: Motorola Literature Distribution; P.O. Box 5405, Denver, Colorado 80217.
1-303-675-2140 or 1-800-441-2447

JAPAN: Motorola Japan Ltd.; SPS, Technical Information Center, 3-20-1, Minami-Azabu. Minato-ku, Tokyo 106-8573 Japan.
81-3-3440-3569

ASIA/PACIFIC: Motorola Semiconductors H.K. Ltd.; Silicon Harbour Centre, 2 Dai King Street, Tai Po Industrial Estate, Tai Po, N.T., Hong Kong. 852-26668334

Customer Focus Center: 1-800-521-6274

Mfax™: RMFAX0@email.sps.mot.com – TOUCHTONE 1-602-244-6609
Motorola Fax Back System – US & Canada ONLY 1-800-774-1848
– <http://sps.motorola.com/mfax/>

HOME PAGE: <http://motorola.com/sps/>



MOTOROLA

