

DM74LS574

Octal D Flip-Flop with 3-STATE Outputs

General Description

The 'LS574 is a high speed low power octal flip-flop with a buffered common Clock (CP) and a buffered common Output Enable (\overline{OE}). The information presented to the D inputs is stored in the flip-flops on the LOW-to-HIGH Clock (CP) transition.

This device is functionally identical to the 'LS374 except for the pinouts.

Connection Diagram

Dual-In-Line Package

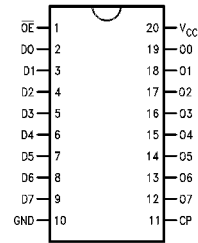

DS009815-1

Order Number **DM74LS574WM** or **DM74LS574N**
See Package Number **M20B** or **N20A**

Logic Symbol

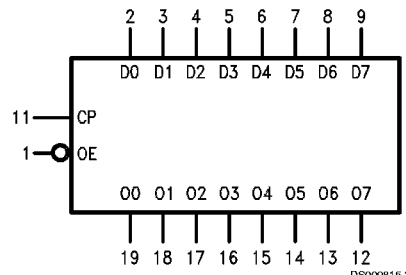

DS009815-2

V_{CC} = Pin 20
GND = Pin 10

Absolute Maximum Ratings (Note 1)

Supply Voltage
Input Voltage

7V
7V

Operating Free Air Temperature Range

DM74LS

Storage Temperature Range

0°C to +70°C

-65°C to +150°C

Recommended Operating Conditions

Symbol	Parameter	DM74LS574			Units
		Min	Nom	Max	
V _{CC}	Supply Voltage	4.75	5	5.25	V
V _{IH}	High Level Input Voltage	2			V
V _{IL}	Low Level Input Voltage			0.8	V
I _{OH}	High Level Output Current			-2.6	mA
I _{OL}	Low Level Output Current			24	mA
T _A	Free Air Operating Temperature	0		70	°C
t _s (H)	Setup Time HIGH or LOW	20			ns
t _s (L)	Dn to CP	20			
t _h (H)	Hold Time HIGH or LOW	0			ns
t _h (L)	Dn to CP	0			
t _w (H)	CP Pulse Width	15			ns
t _w (L)	HIGH or LOW	15			

Note 1: The "Absolute Maximum Ratings" are those values beyond which the safety of the device cannot be guaranteed. The device should not be operated at these limits. The parametric values defined in the "Electrical Characteristics" table are not guaranteed at the absolute maximum ratings. The "Recommended Operating Conditions" table will define the conditions for actual device operation.

Electrical Characteristics

over recommended operating free air temperature range (unless otherwise noted)

Symbol	Parameter	Conditions	Min	Typ (Note 2)	Max	Units
V _I	Input Clamp Voltage	V _{CC} = Min, I _I = -18 mA			-1.5	V
V _{OH}	High Level Output Voltage	V _{CC} = Min, I _{OH} = Max, V _{IL} = Max, V _{IH} = Min	2.4	3.3		V
V _{OL}	Low Level Output Voltage	V _{CC} = Min, I _{OL} = Max, V _{IL} = Max, V _{IH} = Min		0.35	0.5	V
		I _{OL} = 12 mA, V _{CC} = Min		0.25	0.4	
I _I	Input Current @ Max Input Voltage	V _{CC} = Max, V _I = 7V			0.1	mA
I _{IH}	High Level Input Current	V _{CC} = Max, V _I = 2.7V			20	μA
I _{IL}	Low Level Input Current	V _{CC} = Max, V _I = 0.4V			-400	μA
I _{OZH}	Off-State Output Current with High Level Output Voltage Applied	V _{CC} = Max, V _O = 2.4V V _{IH} = Min, V _{IL} = Max			20	μA
I _{OZL}	Off-State Output Current with Low Level Output Voltage Applied	V _{CC} = Max, V _O = 0.4V V _{IH} = Min, V _{IL} = Max			-20	μA
I _{OS}	Short Circuit (Note 3) Output Current	V _{CC} = Max	-30		-130	mA
I _{CC}	Supply Current	V _{CC} = Max (Note 4)			45	mA

Note 2: All typicals are at V_{CC} = 5V, T_A = 25°C.

Note 3: Not more than one output should be shorted at a time, and the duration should not exceed one second.

Note 4: I_{CC} is measured with the DATA inputs grounded and the OUTPUT CONTROLS at 4.5V.

Switching Characteristics

$V_{CC} = +5.0V, T_A = +25^\circ C$

Symbol	Parameter	$R_L = 2\text{ k}\Omega,$ $C_L = 45\text{ pF}$		Units
		Min	Max	
f_{max}	Maximum Clock Frequency	35		MHz
t_{PLH}	Propagation Delay	28		ns
t_{PHL}	CP to On	28		
t_{PZH}	Output Enable Time	28		ns
t_{PZL}		28		
t_{PHZ}	Output Disable Time	20		ns
t_{PLZ}		25		

Functional Description

The LS574 consists of eight edge-triggered flip-flops with individual D-type inputs and 3-STATE true outputs. The buffered clock and buffered Outputs Enable are common to all flip-flops. The eight flip-flops will store the state of their individual D inputs that meet the setup and hold times requirements on the LOW-to-HIGH Clock (CP) transition. With the Output Enable (\overline{OE}) LOW, the contents of the eight flip-flops are available at the outputs. When the \overline{OE} is HIGH, the outputs go to the high impedance state. Operation of the \overline{OE} input does not affect the state of the flip-flops.

Truth Table

Inputs		Outputs	
Dn	CP	OE	On
H	↗	L	H
L	↘	L	L
X	X	H	Z

H = HIGH Voltage Level
L = LOW Voltage Level
X = Immaterial
Z = High Impedance

Logic Diagram

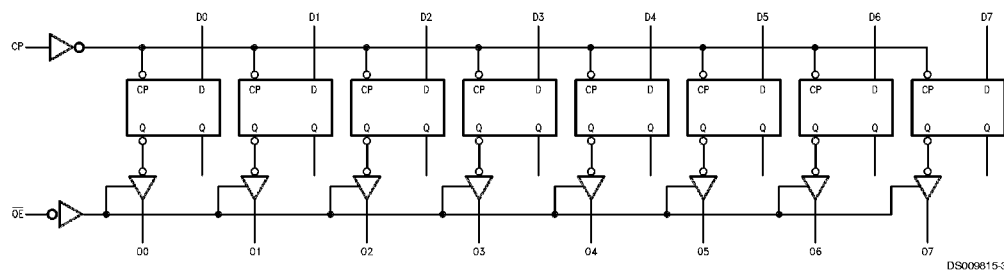

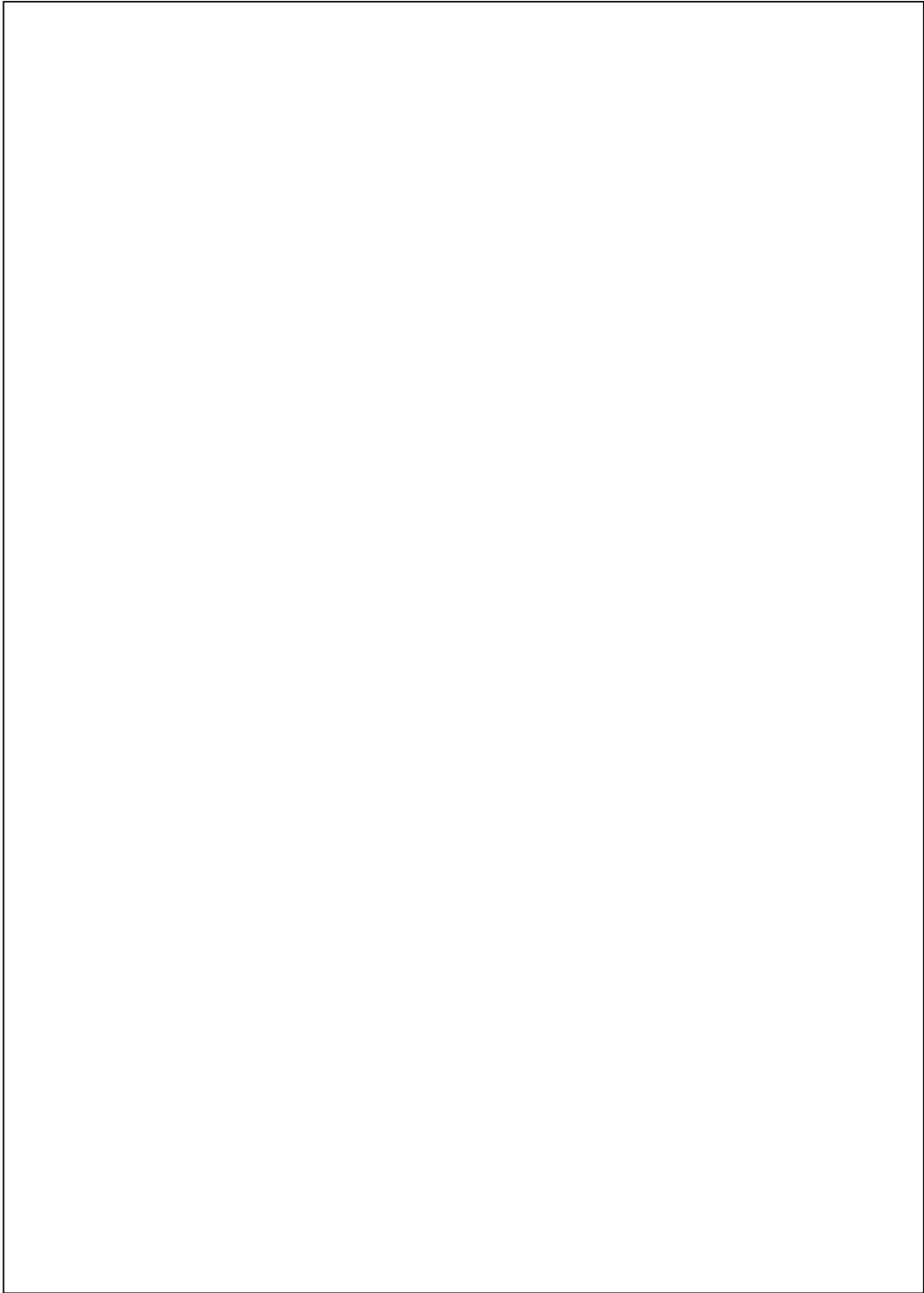

Physical Dimensions inches (millimeters) unless otherwise noted

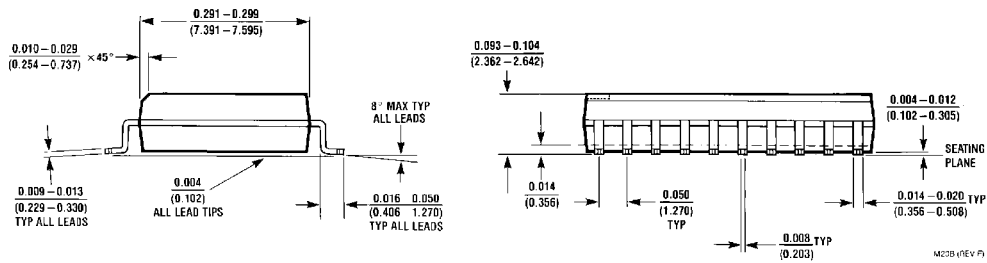
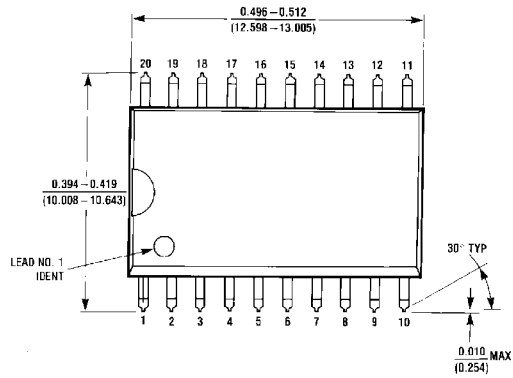

20-Lead Wide Small Outline Molded Package (M)
Order Number DM74LS574WM
Package Number M20B

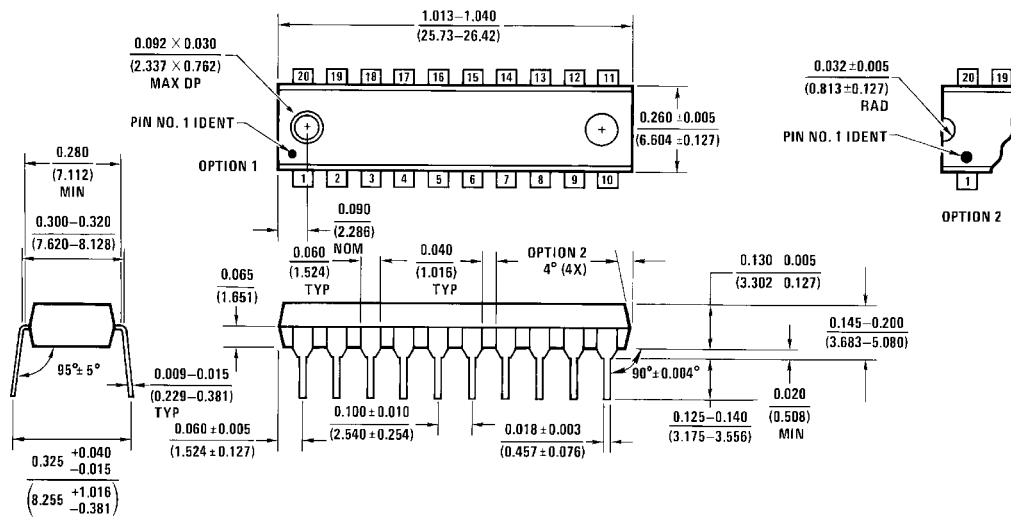

20-Lead Molded Dual-In-Line Package (N)
Order Number DM74LS574N
Package Number N20A