



QUAD PARALLEL REGISTER

The MC54/74F379 is a 4-bit register with a buffered common enable. This device is similar to the F175 but features the common Enable rather than common Master Reset.

The F379 consists of four edge-triggered D-type flip-flops with individual D inputs and Q and \bar{Q} outputs. The Clock (CP) and Enable (E) inputs are common to all flip-flops. When E is HIGH, the register will retain the present data independent of the CP input. The \bar{D}_n and E inputs can change when the clock is in either state, provided that the recommended setup and hold times are observed. This circuit is designed to prevent false clocking by transitions on the E input.

- Edge-Triggered D-Type Inputs
- Buffered Positive Edge-Triggered Clock
- Buffered Common Enable Input
- True and Complement Outputs

CONNECTION DIAGRAM (TOP VIEW)

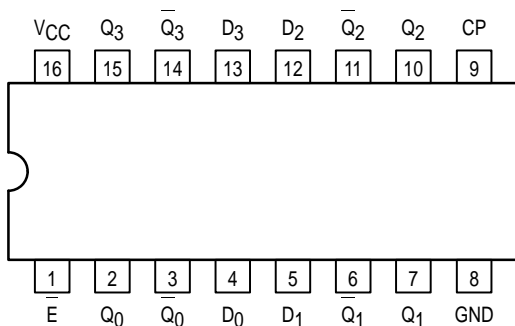

FUNCTION TABLE

Inputs		Outputs		
E	CP	\bar{D}_n	Q_n	\bar{Q}_n
H		X	NC	NC
L		H	H	L
L		L	L	H

H = HIGH Voltage Level
 L = LOW Voltage Level
 X = Don't Care
 NC = No Change

MC54/74F379

QUAD PARALLEL REGISTER WITH ENABLE

FAST™ SCHOTTKY TTL

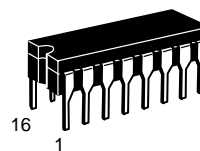

J SUFFIX
 CERAMIC
 CASE 620-09

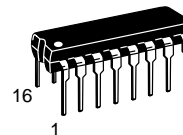

N SUFFIX
 PLASTIC
 CASE 648-08

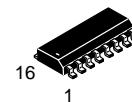

D SUFFIX
 SOIC
 CASE 751B-03

ORDERING INFORMATION

MC54FXXXJ Ceramic
 MC74FXXXN Plastic
 MC74FXXXD SOIC

LOGIC SYMBOL

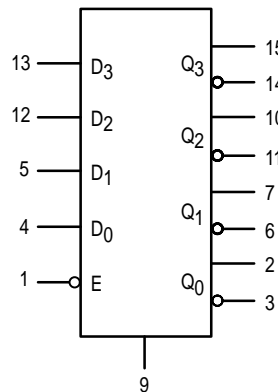

V_{CC} = PIN 16
 GND = PIN 8

LIFETIME BUY

LAST SHIP 30/09/99
 LAST ORDER 31/03/99

MC54/74F379

LOGIC DIAGRAM

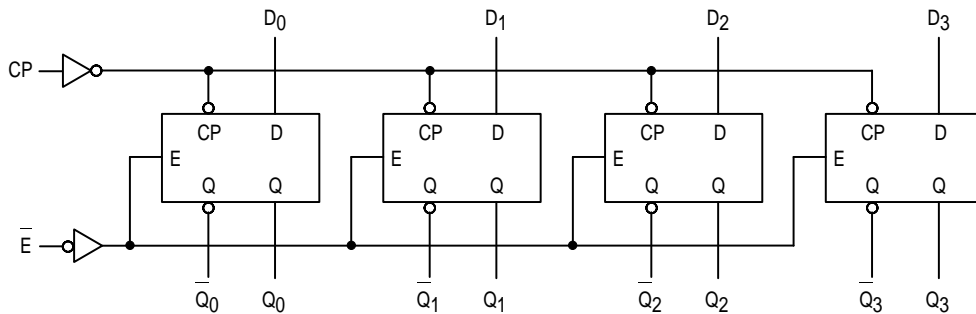

GUARANTEED OPERATING RANGES

Symbol	Parameter		Min	Typ	Max	Unit
V _{CC}	Supply Voltage	54, 74	4.5	5.0	5.5	V
T _A	Operating Ambient Temperature Range	54	-55	25	125	°C
		74	0	25	70	
I _{OH}	Output Current — HIGH	54, 74			-1.0	mA
I _{OL}	Output Current — LOW	54, 74			20	mA

DC CHARACTERISTICS OVER OPERATING TEMPERATURE RANGE (unless otherwise specified)

Symbol	Parameter	Limits			Unit	Test Conditions
		Min	Typ	Max		
V _{IH}	Input HIGH Voltage	2.0			V	Guaranteed Input HIGH Voltage
V _{IL}	Input LOW Voltage			0.8	V	Guaranteed Input LOW Voltage
V _{IK}	Input Clamp Diode Voltage			-1.2	V	V _{CC} = MIN, I _{IN} = -18 mA
V _{OH}	Output HIGH Voltage	54, 74	2.5		V	I _{OL} = -1.0 mA, V _{CC} = 4.5 V
		74	2.7		V	I _{OL} = -1.0 mA, V _{CC} = 4.75 V
V _{OL}	Output LOW Voltage			0.5	V	I _{OL} = 20 mA, V _{CC} = MIN
I _{IH}	Input HIGH Current			20	μA	V _{CC} = MAX, V _{IN} = 2.7 V
				0.1	mA	V _{CC} = MAX, V _{IN} = 7.0 V
I _{IL}	Input LOW Current			-0.6	mA	V _{CC} = MAX, V _{IN} = 0.5 V
I _{OS}	Output Short Circuit Current (Note 2)	-60		-150	mA	V _{CC} = MAX, V _{OUT} = 0 V
I _{CC}	Power Supply Current		28	40	mA	V _{CC} = MAX, D = E = GND, CP = \square

NOTES:

- For conditions shown as MIN or MAX, use the appropriate value specified under recommended operating conditions for the applicable device type.
- Not more than one output should be shorted at a time, nor for more than 1 second.

LIFETIME BUY

LAST SHIP 30/09/99
LAST ORDER 31/03/99

MC54/74F379

AC CHARACTERISTICS

Symbol	Parameter	54/74F			54F		74F		Unit
		$T_A = +25^\circ\text{C}$ $V_{CC} = 5.0\text{ V}$ $C_L = 50\text{ pF}$			$T_A = -55^\circ\text{C to } +125^\circ\text{C}$ $V_{CC} = 5.0\text{ V} \pm 10\%$ $C_L = 50\text{ pF}$		$T_A = 0^\circ\text{C to } +70^\circ\text{C}$ $V_{CC} = 5.0\text{ V} \pm 10\%$ $C_L = 50\text{ pF}$		
		Min	Typ	Max	Min	Max	Min	Max	
f_{max}	Maximum Clock Frequency	100	140		90		100		MHz
t_{PLH}	Propagation Delay	3.5	5.0	6.5	3.5	8.5	3.5	7.5	ns
t_{PHL}	CP to Q_n, \bar{Q}_n	5.0	6.5	8.5	5.0	10.5	5.0	9.5	

AC OPERATING REQUIREMENTS

Symbol	Parameter	54/74F			54F		74F		Unit
		$T_A = +25^\circ\text{C}$ $V_{CC} = 5.0\text{ V}$			$T_A = -55^\circ\text{C to } +125^\circ\text{C}$ $V_{CC} = 5.0\text{ V} \pm 10\%$		$T_A = 0^\circ\text{C to } +70^\circ\text{C}$ $V_{CC} = 5.0\text{ V} \pm 10\%$		
		Min	Typ	Max	Min	max	Min	Max	
$t_{\text{S}}(\text{H})$	Setup Time, HIGH or LOW	3.0			3.0		3.0		ns
$t_{\text{S}}(\text{L})$	D_n to CP	3.0			3.0		3.0		
$t_{\text{H}}(\text{H})$	Hold Time, HIGH or LOW	1.0			1.0		1.0		ns
$t_{\text{H}}(\text{L})$	D_n to CP	1.0			1.0		1.0		
$t_{\text{S}}(\text{H})$	Setup Time, HIGH or LOW	6.0			6.0		6.0		ns
$t_{\text{S}}(\text{L})$	\bar{E} to CP	6.0			6.0		6.0		
$t_{\text{H}}(\text{H})$	Hold Time, HIGH or LOW	2.0			2.0		2.0		ns
$t_{\text{H}}(\text{L})$	\bar{E} to CP	2.0			2.0		2.0		
$t_{\text{W}}(\text{H})$	CP Pulse Width, HIGH or LOW	4.0			4.0		4.0		ns
$t_{\text{W}}(\text{L})$		5.0			5.0		5.0		

LIFETIME BUY

LAST SHIP 30/09/99
LAST ORDER 31/03/99

LIFETIME BUY

LAST ORDER 31/03/99 LAST SHIP 30/09/99

Mfax is a trademark of Motorola, Inc.

Motorola reserves the right to make changes without further notice to any products herein. Motorola makes no warranty, representation or guarantee regarding the suitability of its products for any particular purpose, nor does Motorola assume any liability arising out of the application or use of any product or circuit, and specifically disclaims any and all liability, including without limitation consequential or incidental damages. "Typical" parameters which may be provided in Motorola data sheets and/or specifications can and do vary in different applications and actual performance may vary over time. All operating parameters, including "Typicals" must be validated for each customer application by customer's technical experts. Motorola does not convey any license under its patent rights nor the rights of others. Motorola products are not designed, intended, or authorized for use as components in systems intended for surgical implant into the body, or other applications intended to support or sustain life, or for any other application in which the failure of the Motorola product could create a situation where personal injury or death may occur. Should Buyer purchase or use Motorola products for any such unintended or unauthorized application, Buyer shall indemnify and hold Motorola and its officers, employees, subsidiaries, affiliates, and distributors harmless against all claims, costs, damages, and expenses, and reasonable attorney fees arising out of, directly or indirectly, any claim of personal injury or death associated with such unintended or unauthorized use, even if such claim alleges that Motorola was negligent regarding the design or manufacture of the part. Motorola and  are registered trademarks of Motorola, Inc. Motorola, Inc. is an Equal Opportunity/Affirmative Action Employer.

How to reach us:

USA/EUROPE/Locations Not Listed: Motorola Literature Distribution; P.O. Box 5405, Denver, Colorado 80217.
1-303-675-2140 or 1-800-441-2447

JAPAN: Motorola Japan Ltd.; SPS, Technical Information Center, 3-20-1, Minami-Azabu. Minato-ku, Tokyo 106-8573 Japan.
81-3-3440-3569

ASIA/PACIFIC: Motorola Semiconductors H.K. Ltd.; Silicon Harbour Centre, 2 Dai King Street, Tai Po Industrial Estate, Tai Po, N.T., Hong Kong. 852-26668334

Customer Focus Center: 1-800-521-6274

Mfax™: RMFAX0@email.sps.mot.com – TOUCHTONE 1-602-244-6609
Motorola Fax Back System – US & Canada ONLY 1-800-774-1848
– <http://sps.motorola.com/mfax/>

HOME PAGE: <http://motorola.com/sps/>



MOTOROLA

