

# LARGE CURRENT/LOW DCR MULTILAYER CHIP BEAD



1.65 x 0.8 x 0.8mm

ACML-0603U

**RoHS**  
Compliant

## FEATURES:

- Suitable for large current applications, current rating up to 6A
- Nickel barrier terminations provide excellent solder heat resistance
- Suitable for flow and reflow soldering
- Other sizes are available

## APPLICATIONS:

- Video equipment, audio equipment
- Automotive electrical equipment
- Communication equipment
- OA equipment and other

## STANDARD SPECIFICATIONS:

**Operating Temperature**  
-55°C to +125°C

**Storage Temperature**  
-10°C to +40°C, 70% RH max.

Part Number	Impedance (Ω) ± 25%	Z Test Freq. (MHz)	DCR (mΩ) Max.	Ir (mA) Max.
ACML-0603U-300	30	100	60	1800
ACML-0603U-600	60	100	100	1200
ACML-0603U-101A	100	100	150	1000
ACML-0603U-220	22	100	10	6000
ACML-0603U-700	70	100	20	4000
ACML-0603U-331	330	100	70	1500
ACML-0603U-391	390	100	120	1200
ACML-0603U-471	470	100	120	1200
ACML-0603U-101B	100	100	30	3000
ACML-0603U-181	180	100	50	2000
ACML-0603U-221	220	100	50	2000
ACML-0603U-601	600	100	150	1000

## Test Conditions and equipments

**DCR:** Milliohmmeter-HP4338B or equivalent.

**Z:** RF Impedance /Material Analyzer-HP4291B or equivalent; Fixture: HP16192A;

**Ir:** Electric Power, Electric current meter, Thermometer. Ir is direct electric current as chip surface temperature rose by 20°C against chip initial surface temperature (Ta)

**Test Frequency:** 100MHz, -20dBm or 50mV

Unless specified, test condition should be Temp.=5~35°C, Humidity=45~85%.

## PART NUMBER IDENTIFICATION

ACML-0603U- [ ] - [ ]

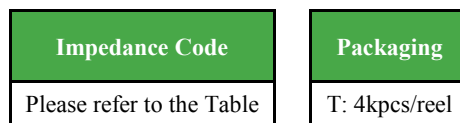

# LARGE CURRENT/LOW DCR MULTILAYER CHIP BEAD

ACML-0603U

RoHS  
Compliant

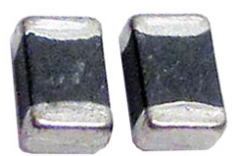

1.65 x 0.8 x 0.8mm

## IMPEDANCE FREQUENCY CHARACTERISTICS

ACML-0603U-300

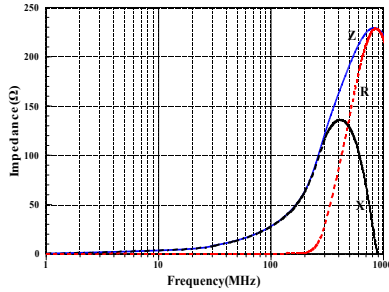

ACML-0603U-600

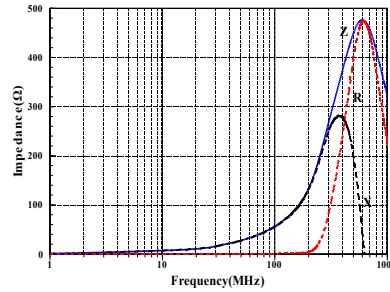

ACML-0603U-101A

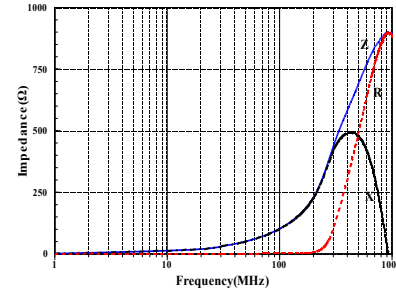

ACML-0603U-220

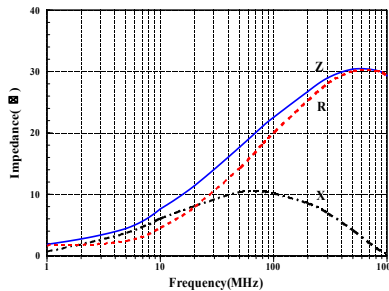

ACML-0603U-700

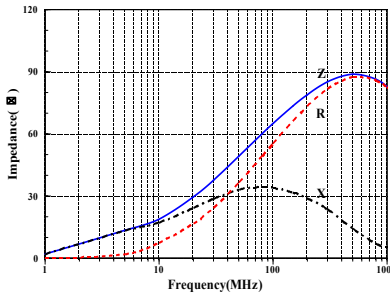

ACML-0603U-331

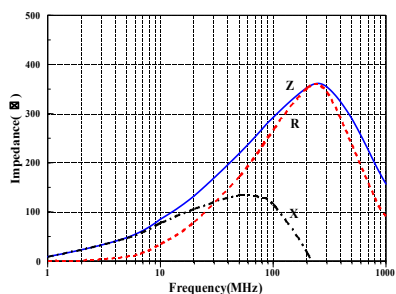

ACML-0603U-391

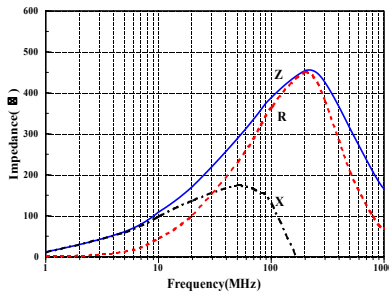

ACML-0603U-471

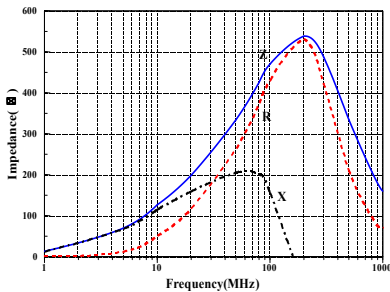

ACML-0603U-101B

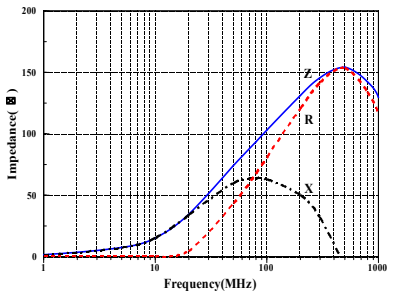

ACML-0603U-181

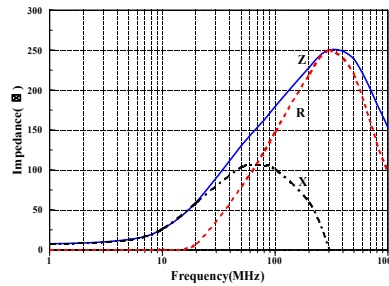

ACML-0603U-221

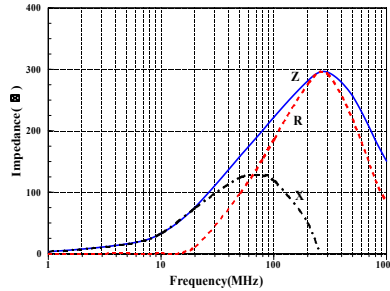

ACML-0603U-601

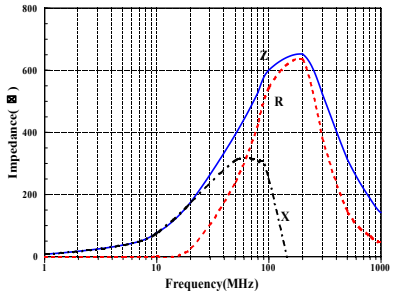

# LARGE CURRENT/LOW DCR MULTILAYER CHIP BEAD

ACML-0603U

RoHS  
Compliant

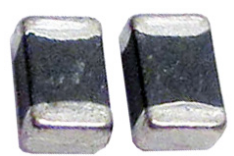

1.65 x 0.8 x 0.8mm

## OUTLINE DIMENSIONS

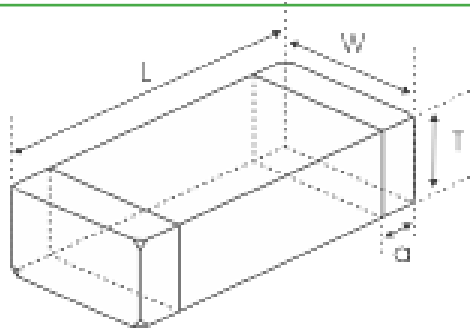

Series	L	W	T	a
ACML-0603U	1.65±0.15	0.80±0.15	0.80±0.15	0.30±0.20

Dimension: mm

## Materials

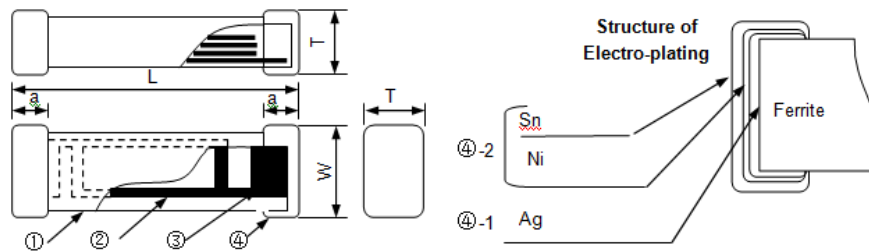

Code	Part Name	Material Name
①	Ferrite Body	Ferrite Powder
②	Inner Coils	Silver Paste
③	Pull-out Electrode (Ag)	Silver Paste
④-1	Terminal Electrode: Inside Ag	Termination Silver Composition
④-2	Electro-Plating: Ni/Sn plating	Plating Chemicals

## REFLOW PROFILE

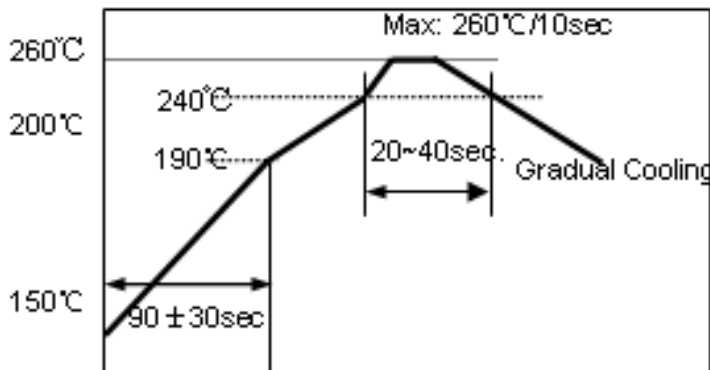

- 1~2 °C /sec. Ramp
- Pre-heating: 150~190 °C /90±30 sec.
- Time above 240 °C: 20~40sec
- Peak temperature: 260 °C Max./10sec.
- Solder paste: Sn/3.0Ag/0.5Cu
- Max.2 times for re-flowing

# LARGE CURRENT/LOW DCR MULTILAYER CHIP BEAD

ACML-0603U

RoHS  
Compliant

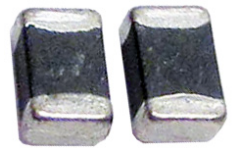

1.65 x 0.8 x 0.8mm

## TAPE & REEL

T= tape and reel (4,000pcs/reel)

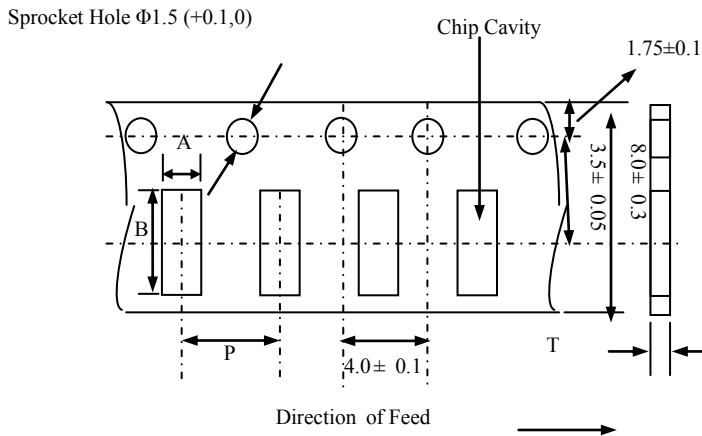

A	B	P	T Max
1.0 $\pm 0.2$	1.8 $\pm 0.2$	4.0 $\pm 0.1$	1.1

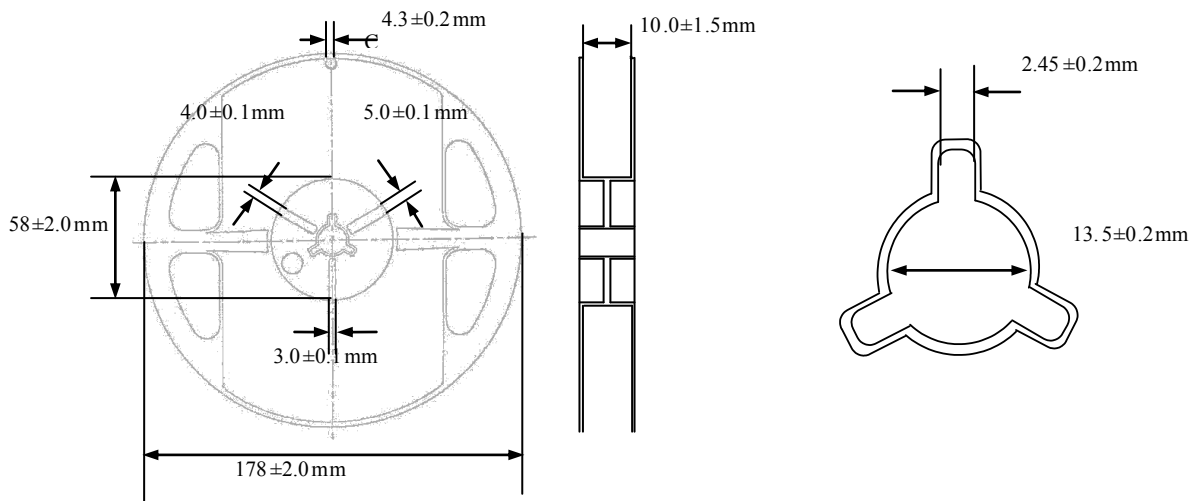

Dimension: mm

**ATTENTION:** Abracon Corporation's products are COTS – Commercial-Off-The-Shelf products; suitable for Commercial, Industrial and, where designated, Automotive Applications. Abracon's products are not specifically designed for Military, Aviation, Aerospace, Life-dependant Medical applications or any application requiring high reliability where component failure could result in loss of life and/or property. For applications requiring high reliability and/or presenting an extreme operating environment, written consent and authorization from Abracon Corporation is required. Please contact Abracon Corporation for more information.

ABRACON IS  
ISO 9001:2008  
CERTIFIED



Visit [www.abracon.com](http://www.abracon.com) for Terms & Conditions of Sale **Revised: 05.19.14**  
30332 Esperanza, Rancho Santa Margarita, California 92688  
tel 949-546-8000 | fax 949-546-800 | [www.abracon.com](http://www.abracon.com)