



Mag Layers USA, INC

Specification Sheet

P/N : **GMLB-160808-Series-SJ-RU**

Products:

[Molded Power Chokes](#)

[Multilayer Chip Inductors](#)

[Lan Transformer](#)

[RF Passive / Antennas](#)

[Automotive](#)

Certifications:

[ISO9001](#)

[IATF16949](#)

[ISO14001](#)

[QC080000](#)

US Office

5406 Bolsa Ave.,
Huntington Beach, CA 92649
(714) 898-8377

Contact Us

www.maglayersusa.com
info@maglayersusa.com

APPLICATION

GMLB chip beads can be used in a variety of electronic applications including:

- Computers and Computer Peripherals
- Cellular Communication Equipment
- Digital Cameras
- Digital Televisions
- Audio Equipment

FEATURES

The GMLB Series is Mag.Layers' line of high quality ferrite chip beads. Using the latest in multilayer technology, we have developed chip beads that are able to resolve all EMI/EMC issues. High quality, reliability, and versatility make the GMLB series chip beads suitable for all your design needs.

- High Reliability
The monolithic inorganic materials used to construct GMLB chips restrain magnetic flux leakage thereby minimizing EMI concerns. GMLB chips are also extremely effective with unstable grounding.
- Small Chip-Shaped Design
The chip-shaped design makes GMLB chip beads ideal for automatic mounting.
- High Soldering Heat Resistance
High quality termination allows both flow and re-flow soldering methods to be applied.
- Sharp High Frequency Characteristics
The GMLB high frequency chip series has sharp impedance characteristics, which make it suitable for high-speed signal lines.

PRODUCT IDENTIFICATION

G M L B - 1 6 0 8 0 8 - 0 0 3 0 Y - S J -RU

① ② ③ ④ ⑤ ⑥

- ① Product Code
- ② Dimension Code
- ③ Impedance (at 100 MHz)
- ④ Series Type
- ⑤ Design Code
- ⑥ Code for Special Specification

PRODUCT DIMENSION

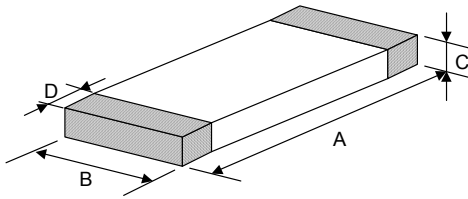

NOTE : Dimensions in mm

PRODUCT NO.	A	B	C	D
GMLB-160808 (0603)	1.6±0.15 (0.063±0.006)	0.8±0.15 (0.031±0.006)	0.8±0.15 (0.031±0.006)	0.3±0.20 (0.012±0.008)

CURRENT DERATING

In operating temperatures exceeding +85°C, derating of current is necessary for chip ferrite beads for which rated current is 1.5A or over. Please apply the derating curve shown below according to the operating temperature.

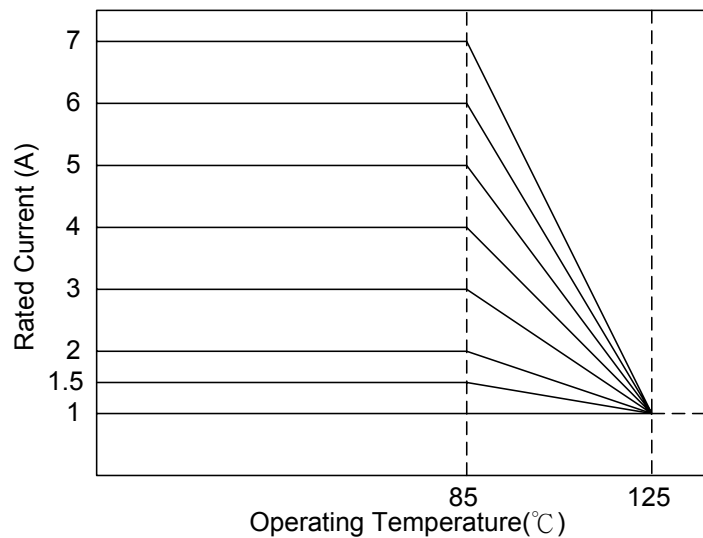

ELECTRICAL REQUIREMENTS

Part Number	Impedance (Ω) at 100 MHz	R _{DC} (Ω) Max.	I _{DC} (mA) Max.	Operating Temp. Range ($^{\circ}\text{C}$)
GMLB-160808-0030Y-SJ-RU	30 \pm 25%	0.20	400	-55 ~ +125
GMLB-160808-0040Y-SJ-RU	40 \pm 25%		300	
GMLB-160808-0060Y-SJ-RU	60 \pm 25%	0.40		
GMLB-160808-0080Y-SJ-RU	80 \pm 25%			
GMLB-160808-0100Y-SJ-RU	100 \pm 25%			
GMLB-160808-0120Y-SJ-RU	120 \pm 25%	0.50	200	
GMLB-160808-0180Y-SJ-RU	180 \pm 25%			
GMLB-160808-0220Y-SJ-RU	220 \pm 25%			
GMLB-160808-0240Y-SJ-RU	240 \pm 25%	0.70	150	
GMLB-160808-0300Y-SJ-RU	300 \pm 25%			
GMLB-160808-0450Y-SJ-RU	450 \pm 25%			
GMLB-160808-0600Y-SJ-RU	600 \pm 25%	1.00	100	
GMLB-160808-1000Y-SJ-RU	1000 \pm 25%			
GMLB-160808-1200Y-SJ-RU	1200 \pm 25%			
GMLB-160808-1500Y-SJ-RU	1500 \pm 25%		200	

- Temperature rise should be less than 40 $^{\circ}\text{C}$ for P-type and less than 25 $^{\circ}\text{C}$ for other types when rated current is applied.

MEASURING METHOD / CONDITION

- Test Instrument:

Z: Agilent 4291B Impedance Analyzer, Test Fixture: Agilent 16192

Osc. Level: 500mV

R_{DC}: Agilent 34401A

- Test Condition:

< Unless otherwise specified >

Temperature: 15 $^{\circ}\text{C}$ to 35 $^{\circ}\text{C}$ Humidity: 25% to 85% RH

< In case of doubt >

Temperature: 25 $^{\circ}\text{C} \pm 2^{\circ}\text{C}$ Humidity: 60% to 70% RH



TYPICAL ELECTRICAL CHARACTERISTICS (T=25°C)

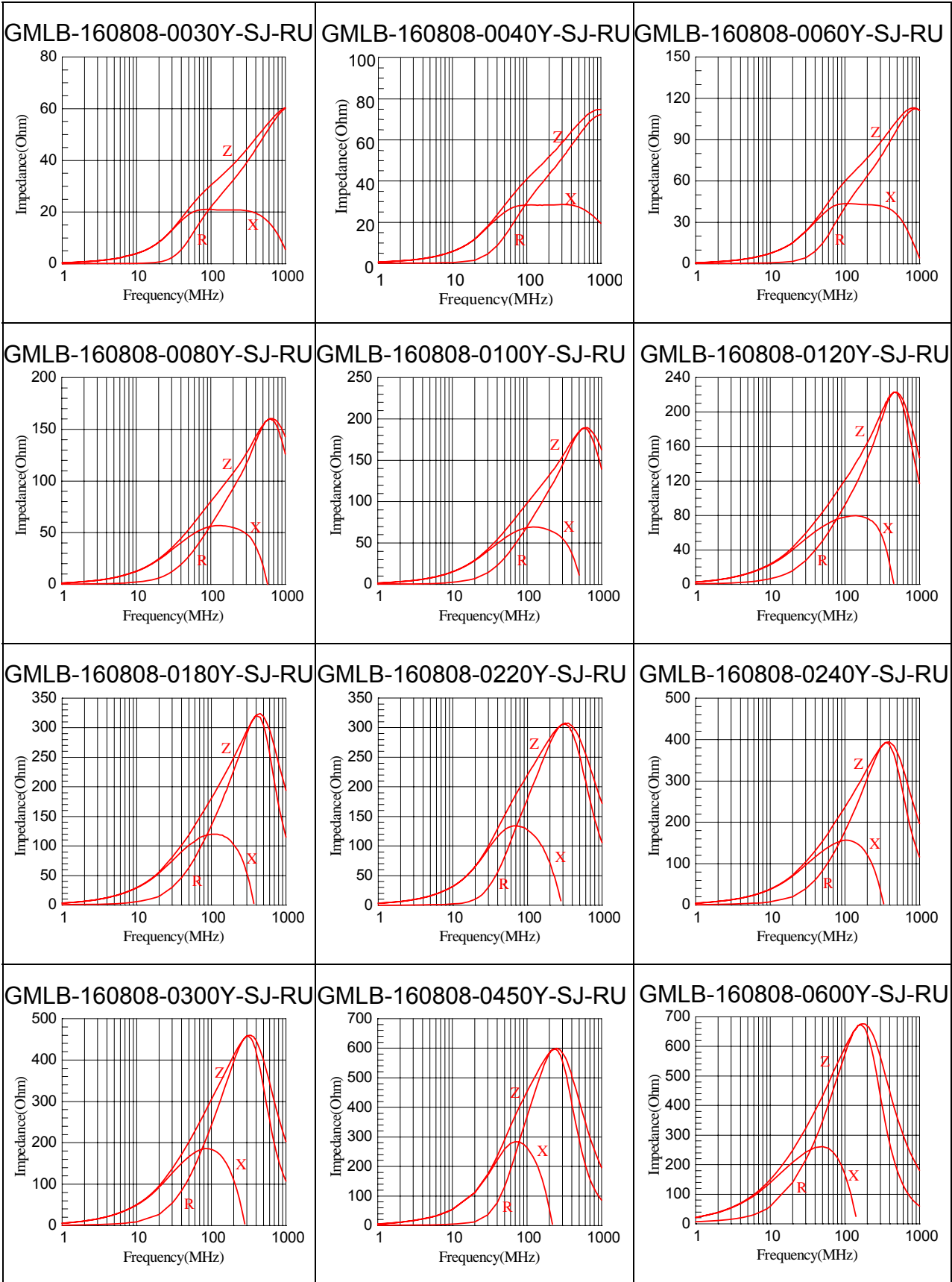

GMLB-160808-1000Y-SJ-RU

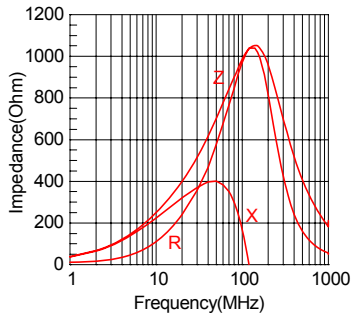

GMLB-160808-1200Y-SJ-RU

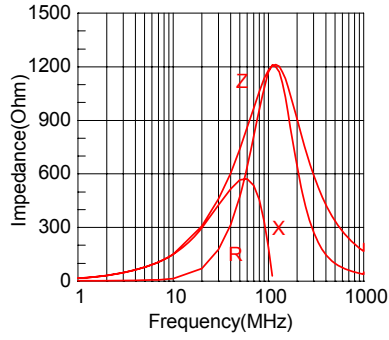

GMLB-160808-1500Y-SJ-RU

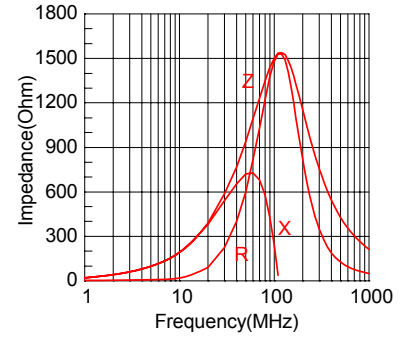

PACKAGING

● Peel-off Force

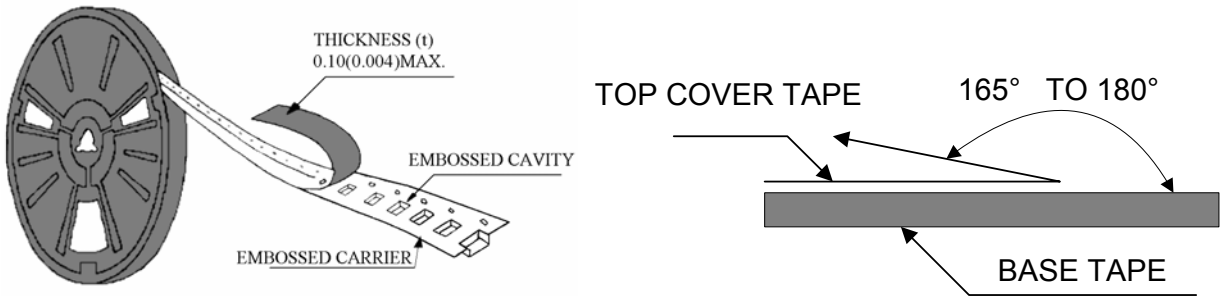

The force for peeling off cover tape is 10 grams in the arrow direction.

● Dimension (Unit: mm)

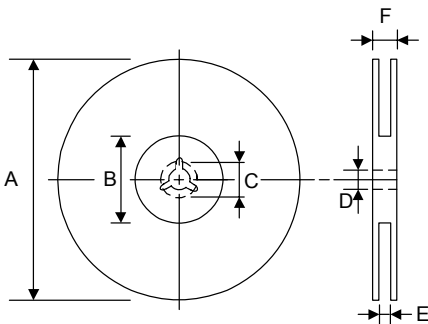

TYPE	A	B	C	D	E	F
8 mm	178±1	60 +0.5 -0	-	13 ±0.2	9 ±0.5	12 ±0.5
12 mm	178±0.3	60 ±0.2	19.3 ±0.1	13.5 ±0.1	13.6 ±0.1	-

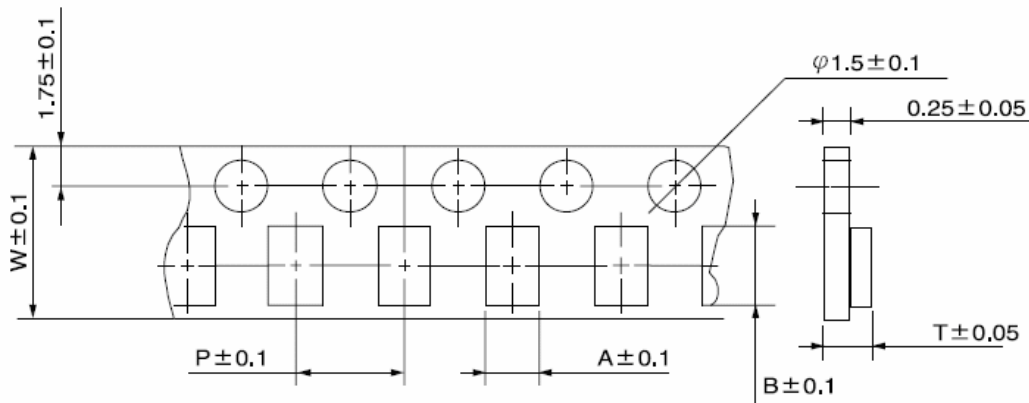

TYPE	SIZE	A	B	W	P	T	CHIPS/REEL
GMLB	160808	1.1	1.9	8	4	1.1, *0.95±0.05	4000

*: For paper reels

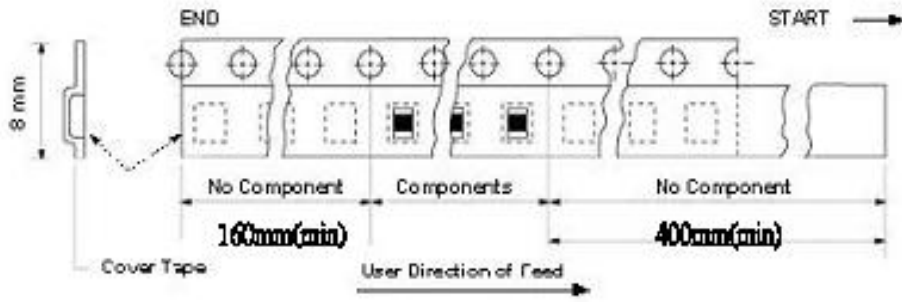

- Taping Quantity

SERIES	1608
PCS/Reel	4000

- Tape Packing Case

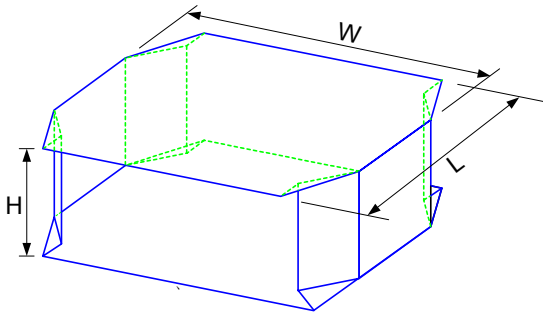

No. of Reels	W	L	H
2	18±0.5	18±0.5	2.4±0.2
3	18±0.5	18±0.5	3.6±0.2
4	18±0.5	18±0.5	4.8±0.2
5	18±0.5	18±0.5	6.0±0.2

Unit: cm

RECOMMENDED PCB LAYOUT

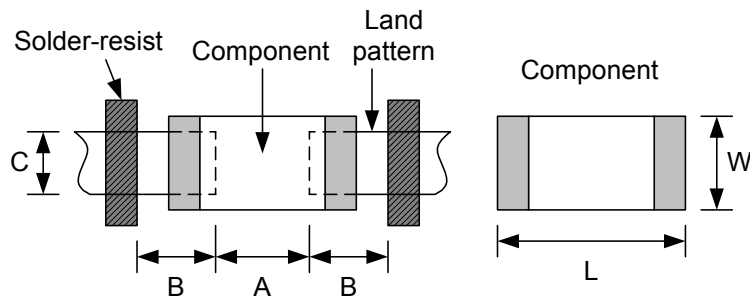

Unit: mm

Type	1608	
Size	L	1.6
	W	0.8
A	0.6~0.8	
B	0.6~0.8	
C	0.6~0.8	

RELIABILITY TEST

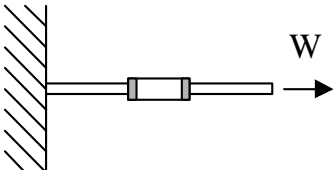
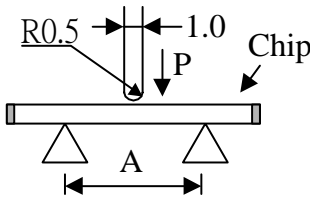
●Mechanical Performance Test				
ITEM	SPECIFICATION	TEST CONDITION		
Solderability	More than 90% of the terminal electrode shall be covered with fresh solder.	Solder: Sn-3.0Ag-0.5Cu Solder Temperature: 245 ± 5°C Flux: Rosin Dip Time: 3 ± 1 Seconds		
Soldering Heat Resistance	The chip shall not crack. More than 75% of the terminal electrode shall be covered with solder.	Solder temperature : 260 ± 5°C Flux: Rosin Dip time: 10 ± 1 seconds		
Terminal Strength	The terminal electrode shall not be broken off nor the ferrite damaged. 	TYPE	W(KGF)	TIME (SEC)
		GMLB-160808	0.6	30 ± 5
Bending Strength	No mechanical damage. The ferrite shall not be damaged. 	TYPE	A(MM)	P(KGF)
		GMLB-160808	1.0	1.0
● Climatic test				
ITEM	SPECIFICATION	TEST CONDITION		
Thermal Shock (Temperature Cycle)	Impedance shall be within ± 20% of the initial value.	Temperature: -55°C~125°C for 30 minutes each, 100 cycles.		
Humidity Resistance		Temperature : 60°C Humidity: 95% RH Time: 1000 ± 12 Hours		
High Temperature Resistance		Temperature : 85°C±2°C Time: 1000 ± 12 Hours		
1. Operating Temperature Range: -55 °C TO +125°C 2. Storage Condition: The temperature should be within -40°C~85°C and humidity should be less than 75% RH. The product should be used within 6 months from the time of delivery.				

RECOMMENDED REFLOW SOLDERING PROFILE

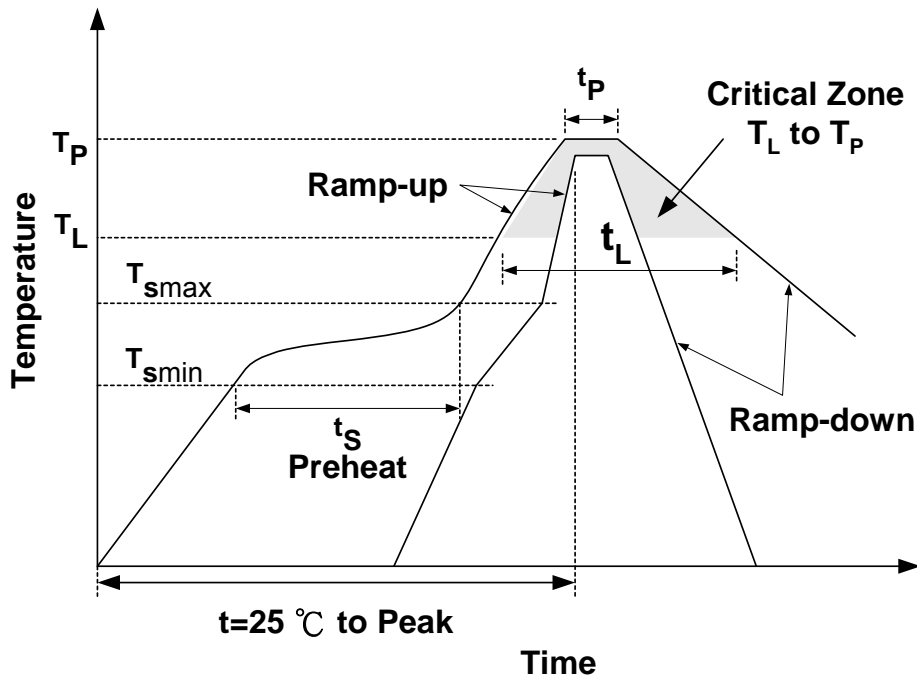

Profile Feature		Sn-Pb	Pb-Free
Preheat	t_s	60~120 seconds	60~180 seconds
	T_{smin}	100°C	150°C
	T_{smax}	150°C	200°C
Average ramp-up rate (T_{smax} to T_P)		3°C/second max.	3°C/second max.
Time main above	Temperature (T_L)	183°C	217°C
	Time (t_L)	60~150 seconds	60~150 seconds
Peak temperature (T_P)		230°C	250~260°C
Time within 5°C of actual peak temperature (t_p)		10 seconds	10 seconds
Ramp-down rate		6°C/sec max.	6°C/sec max.
Time 25°C to peak temperature		6 minutes max.	8 minutes max.

NOTES

The contents of this data sheet are subject to change without notice. Please confirm the specifications and delivery conditions when placing your order.