



3-terminal filters

For large-current power line

YFF-HC series

YFF31HC 3216 [1206 inch]* Feed through filter

* Dimensions Code JIS[EIA]

Product compatible with RoHS directive
Lead-free compatible

3-terminal filters

For large-current power line

Overview of the YFF-HC series

FEATURES

- Small and high-performance EMC components.
- Good attenuation characteristic in a wide band range.
- For large current (6A to 10A) applications.

APPLICATION

Power line of AV (LCD, PDP) products and information products (PC, server).
Countermeasures against power-supply noise of communications infrastructure PA.

PART NUMBER CONSTRUCTION

YFF	31	HC	2A	105	M	T	□□	0	N			
Series name	L x W dimensions		Rated voltage		Capacitance		Tolerance	Taping	TDK internal code	Reel size		Internal electrode Ni
	Code	mm	Code	V	Code	pF				Code	mm	
	31	3.2x1.6	HC	Large current	1H	50	103	10,000	M	±20%	0	ø178
					2A	100	153	15,000			9	ø330
							105	1,000,000 (1.0μF)				

PACKAGING STYLE AND SPECIFICATIONS

Type	Package quantity (piece/reel)		Individual weight (g)
	ø178	ø330	
YFF31HC	2,000	10,000	0.0342

- Conformity to RoHS directive: this means that, in conformity with EU directive 2002/95/EC, lead, cadmium, mercury, hexavalent chromium, and specific bromine-based flame retardants, PBB and PBDE, have not been used, except for exempted applications.
- Please contact our Sales office when your application is considered the following: The device's failure or malfunction may directly endanger human life (e.g. application for automobile/aircraft/medical/nuclear power devices, etc.)

 Please be sure to request delivery specifications that provide further details on the features and specifications of the products for proper and safe use. Please note that the contents may change without any prior notice due to reasons such as upgrading.

Overview of the YFF-HC series

RECOMMENDED SOLDERING CONDITION

REFLOW SOLDERING

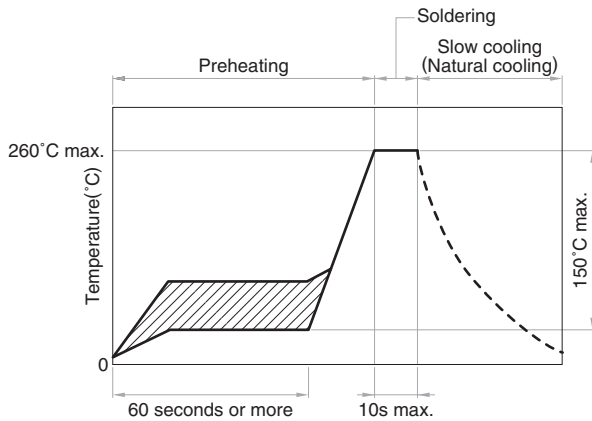

HAND SOLDERING

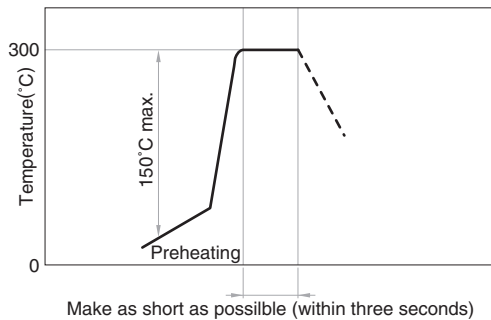

REMINDERS FOR USING THESE PRODUCTS

- Before soldering, be sure to preheat components. The ΔT preheating temperature must be 150°C max. with attention paid to thermal shock.
- Natural cooling of components in the air is recommended. On the other hand, when dipping them in a solvent for purposes, such as cleaning, make sure that the temperature difference (ΔT) is 100°C.
- When performing hand soldering for circuit modification, apply the soldering iron to the copper foil area of the printed circuit board for 3 seconds or less. The temperature of the iron tip should not exceed 300°C.
- Use a wrist band to discharge static electricity in your body through the grounding wire.
- When incorporating the printed circuit board on which this product is mounted into a frame, etc., do not apply stress to the product through local bending of the board by tightening of screws, etc.

YFF-HC series YFF31HC type (Feed through filter)

SHAPE & DIMENSIONS

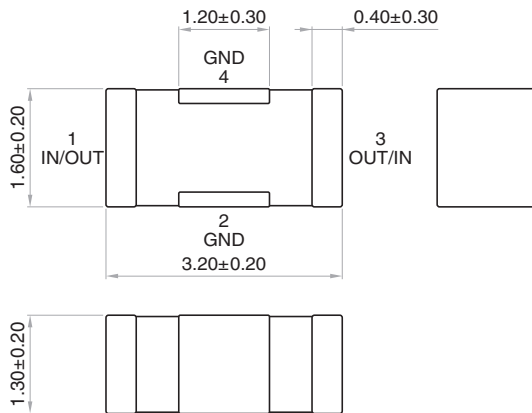

RECOMMENDED LAND PATTERN

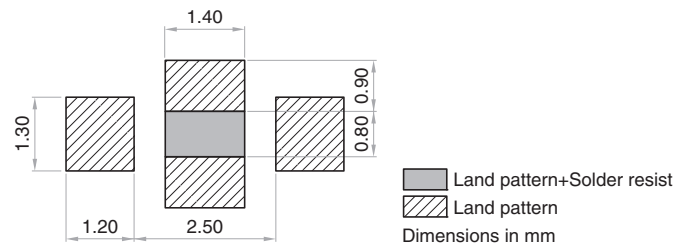

* Make sure to connect the GND terminal of this product and the GND of the mounting circuit board by using through holes so that the distance between them is the shortest.

ELECTRICAL CHARACTERISTICS

CHARACTERISTICS SPECIFICATION TABLE

Insertion loss 40dB frequency range (MHz)	Rated voltage Edc (V)	Rated current Idc (A)	Operating temperature range (°C)	Storage temperature range (After mount) (°C)	Part No.*
0.8 to 2000	100	6	-55 to +125	-55 to +125	YFF31HC2A105MT000N
0.8 to 2000	100	6	-55 to +125	-55 to +125	YFF31HC2A105MT009N
7 to 2000	100	10	-55 to +125	-55 to +125	YFF31HC2A104MT000N
7 to 2000	100	10	-55 to +125	-55 to +125	YFF31HC2A104MT009N
40 to 2000	50	10	-55 to +125	-55 to +125	YFF31HC1H153MT000N
40 to 2000	50	10	-55 to +125	-55 to +125	YFF31HC1H153MT009N
60 to 2000	100	10	-55 to +125	-55 to +125	YFF31HC2A103MT000N
60 to 2000	100	10	-55 to +125	-55 to +125	YFF31HC2A103MT009N

* The part numbers are TDK's standard specification products.

ELECTRICAL CHARACTERISTICS GRAPH (EXAMPLE)

INSERTION LOSS VS. FREQUENCY CHARACTERISTICS

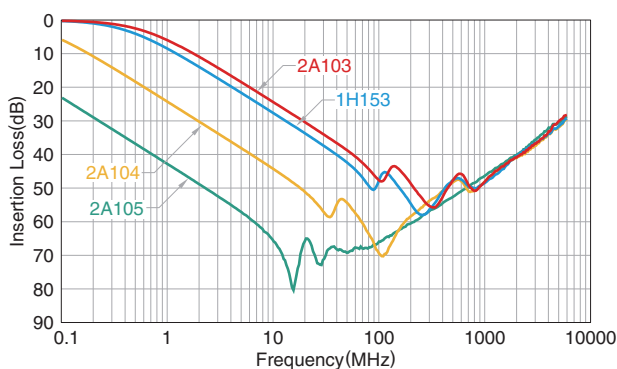

RATED CURRENT VS. TEMPERATURE CHARACTERISTICS (DERATING)

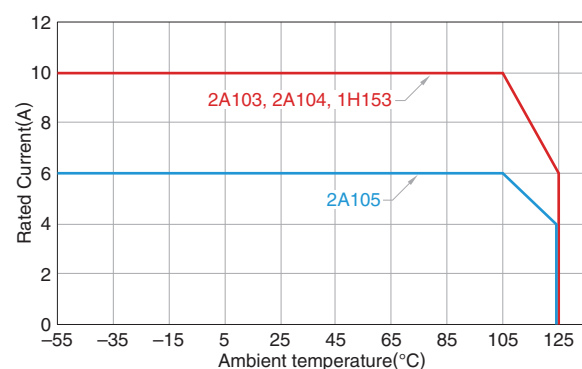

⚠ Please be sure to request delivery specifications that provide further details on the features and specifications of the products for proper and safe use. Please note that the contents may change without any prior notice due to reasons such as upgrading.

YFF-HC series Packaging style

REEL DIMENSIONS

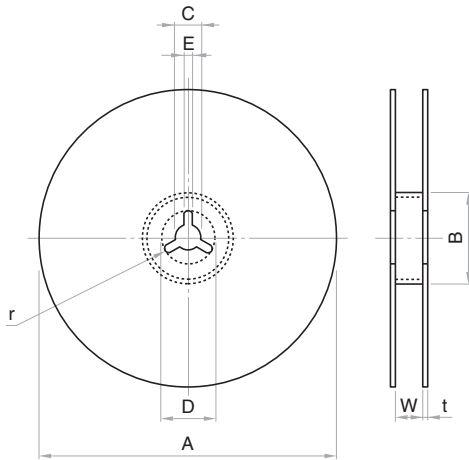

Unit: mm

Reel	A	B	C	D	E	W	t	r
ø178	ø178±2.0	ø60±2.0	ø13±0.5	ø21±0.8	2.0±0.5	9.0±0.3	2.0±0.5	1.0
ø330	ø382 max.(ø330 nom.)	ø50 min.	ø13±0.5	ø21±0.8	2.0±0.5	10.0±1.5	2.0±0.5	1.0

TAPE DIMENSIONS

Plastic tape

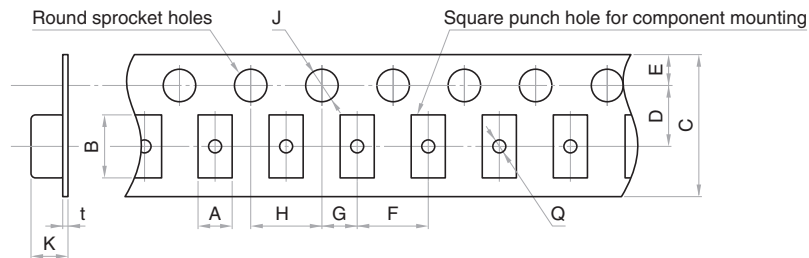

Unit: mm

Type	A	B	C	D	E	F	G	H	J	K	t	Q
YFF31HC	1.90 typ.	3.50 typ.	8.00±0.30	3.5±0.05	1.75±0.10	4.00±0.10	2.0±0.05	4.00±0.10	ø1.5+0.10/-0	2.50 max.	0.30 max.	ø0.50 min.

Please be sure to request delivery specifications that provide further details on the features and specifications of the products for proper and safe use. Please note that the contents may change without any prior notice due to reasons such as upgrading.