

MARKETING SALES DRAWING

DIMENSIONS IN INCHES - DO NOT SCALE THIS DRAWING
DIMENSIONS IN METRIC - []

This drawing is the property of Tusonix, Inc., and may not be used, reproduced, published or disclosed to others without expressed authorization by Tusonix Inc.

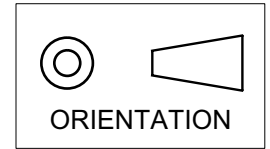

Electrical Testing
per Tusonix standard
test plans and Mil-Std-202
Test Methods.

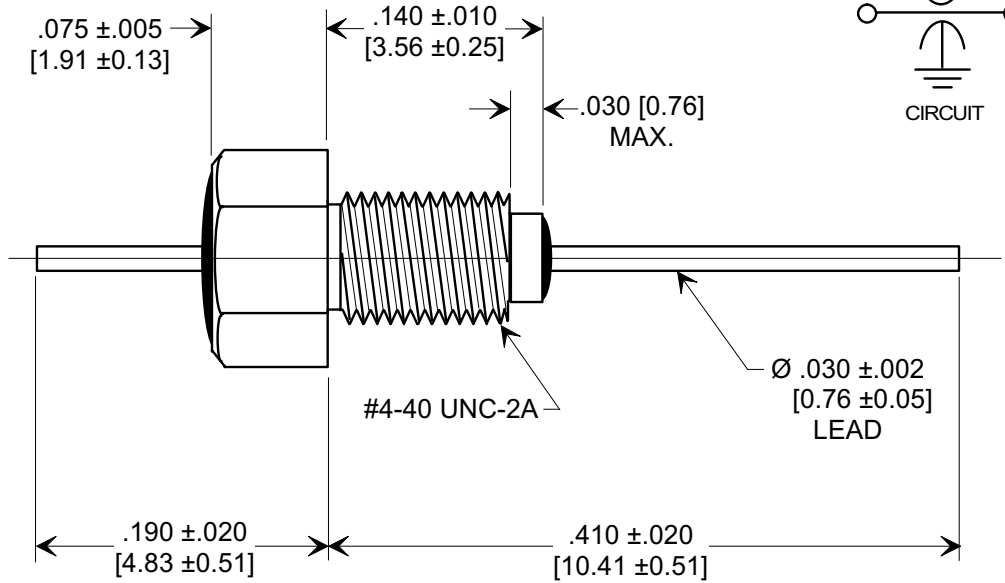
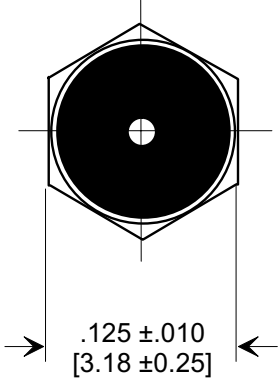
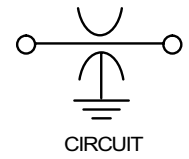

MOUNTING HARDWARE

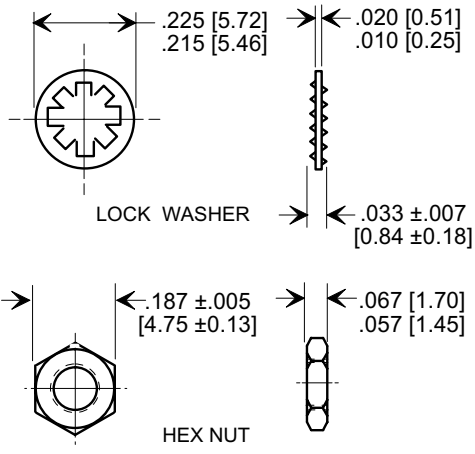

NOTES:

1. OPERATING TEMPERATURE RANGE: -55°C TO +125°C.
2. SILVER PLATED CASE, LEAD AND MOUNTING HARDWARE.
3. MAX. RECOMMENDED MOUNTING TORQUE : 2.0 lb. - in.
4. MAX. RECOMMENDED SOLDERING TEMPERATURE : 260°C. SEE INSTALLATION RECOMMENDATIONS.
5. NUT AND LOCK WASHER INCLUDED.
6. TUSONIX STANDARD PART NUMBER: 4403-035. TUSONIX RoHS COMPLIANT PART NUMBER: 4403-035 LF. CUSTOMER MUST SPECIFY STANDARD OR RoHS PART NUMBER WHEN ORDERING.
7. PART MARKING: TRADEMARK AND VARIATION NUMBER ON HEX FLATS. STANDARD PART: BLACK INK. RoHS PART: GREEN INK.

10,000	GMV	70	50	10	4	21	35	50	60
CAP.(pf)	TOLERANCE	+85 °C	+125 °C	DC CURRENT (AMPS)	1 MHz	10 MHz	100 MHz	1 GHz	10 GHz
		DC WORKING VOLTAGE							

REVISION RECORD	Original Release C.O. 6965	0	-040 & -680 ADDED, DC WAS5. E.C. 11-20-92	1	RDN TO COMP FMT. S.M. 07-16-02	2	ADDED AND REVISED NOTES. S.M. 04-26-06	20020715-1-23	3	20060421-3-02	--TOLERANCES-- Unless Otherwise Specified		Title MINI BUSHING STYLE EMI FILTER	
	DECIMAL ± NOTED										Drawn S.M. 06-10-02 Scale 8 X			
	ANGLES ± NOTED										Approved J.Mc. 06-10-02			
	TUSONIX TUCSON, ARIZONA										A	4403-035		