

RF Power Feed-Through Capacitors With Conductor Rod, Class 1 Ceramic



QUICK REFERENCE DATA				
DESCRIPTION	VALUE			
Ceramic Class	1			
Ceramic Dielectric	R85	R85, R230		
Type	DBF 050166	DBF 050180		
Voltage (V_p)	25 000	20 000	30 000	40 000
Min. Capacitance (pF)	500	3000	1000	2000
Max. Capacitance (pF)	500	3000	2000	2000
Mounting	Screw terminal			

MATERIAL

Capacitor elements made from class 1 ceramic dielectric with noble metal electrodes.

Connection terminals:
made from copper / brass, silver plated.

FINISH

Capacitor body completely protective lacquered.

The DBF-styled capacitors features umbrella-shaped insulation rims made from silicone elastomer to minimize the adverse effects of moisture, dust and other impurities in the working environment and to improve the characteristics of the electrical field.

MARKING

Type designator, capacitance value and tolerance, rated peak voltage, ceramic material code, production date code, manufacturer logo.

ACCESSORIES ADDED

All feed-through capacitors are supplied with the necessary nuts and washers to make the connection to the conductor rod.

FEATURES

- High voltage ratings
- High feed-through currents
- The insulation rim is made from silicone rubber minimize the adverse effects of moisture, dust and other impurities in the working environment

APPLICATIONS

Filtering purposes in industrial and medical RF power equipment where high voltages and high feed-through currents are required.

CAPACITANCE RANGE

500 pF to 3.0 nF

CAPACITANCE TOLERANCE

$\pm 20 \%$, $\pm 10 \%$

CERAMIC DIELECTRICS

- R85 (TCC - 750 ppm/K)
- R230 (TCC - 750 ppm/K)

RATED VOLTAGE

- 20 kV_p
- 25 kV_p
- 30 kV_p
- 40 kV_p

DIELECTRIC STRENGTH TEST

- (1) 50 000 V_{DC}, 5 minutes; $U_R = 30 \text{ kV}_p$ and 40 kV_p types only
- (2) 160 % to 200 % of rated AC voltage (50 Hz, 5 minutes)

DISSIPATION FACTOR

Max. 0.05 %

Measuring frequencies:

1 MHz (< 1 nF); 300 kHz or 100 kHz (> 1 nF)

INSULATION RESISTANCE

Min. 10 000 M Ω (at 25 °C)

OPERATING TEMPERATURE RANGE

-55 °C to +100 °C

SAP PART NUMBER AND ELECTRICAL DATA						
PART NUMBER	CERAMIC	CAP. VALUES (pF)	RATED VOLTAGE (kV _P)	RATED POWER (1) (kvar)	RATED CURRENT (A _{RMS})	FEED-THROUGH CURRENT (2) (A)
TYPE DBF 050166						
DBF50166BQ501##BJ1	R85	500	25.0	70.0	50.0	70.0
TYPE DBF 050180						
DBF50180WV102##BJ1	R85	1000	30.0	70.0	87.0	70.0
DBF50180WV152##BJ1		1500				
DBF50180WV202##BK1	R230	2000	30.0			
DBF50180WZ202##BK2		2000	40.0			
DBF50180WP302##BK1		3000	20.0	100.0	60.0	

Notes

- ## 14th to 15th digit: capacitance tolerance code $\pm 20\% = 38$, $\pm 10\% = 36$
- (1) The surface temperature during operation must not exceed $+100\text{ }^\circ\text{C}$
- (2) DC or low frequency RMS current ($< 20\text{ kHz}$)

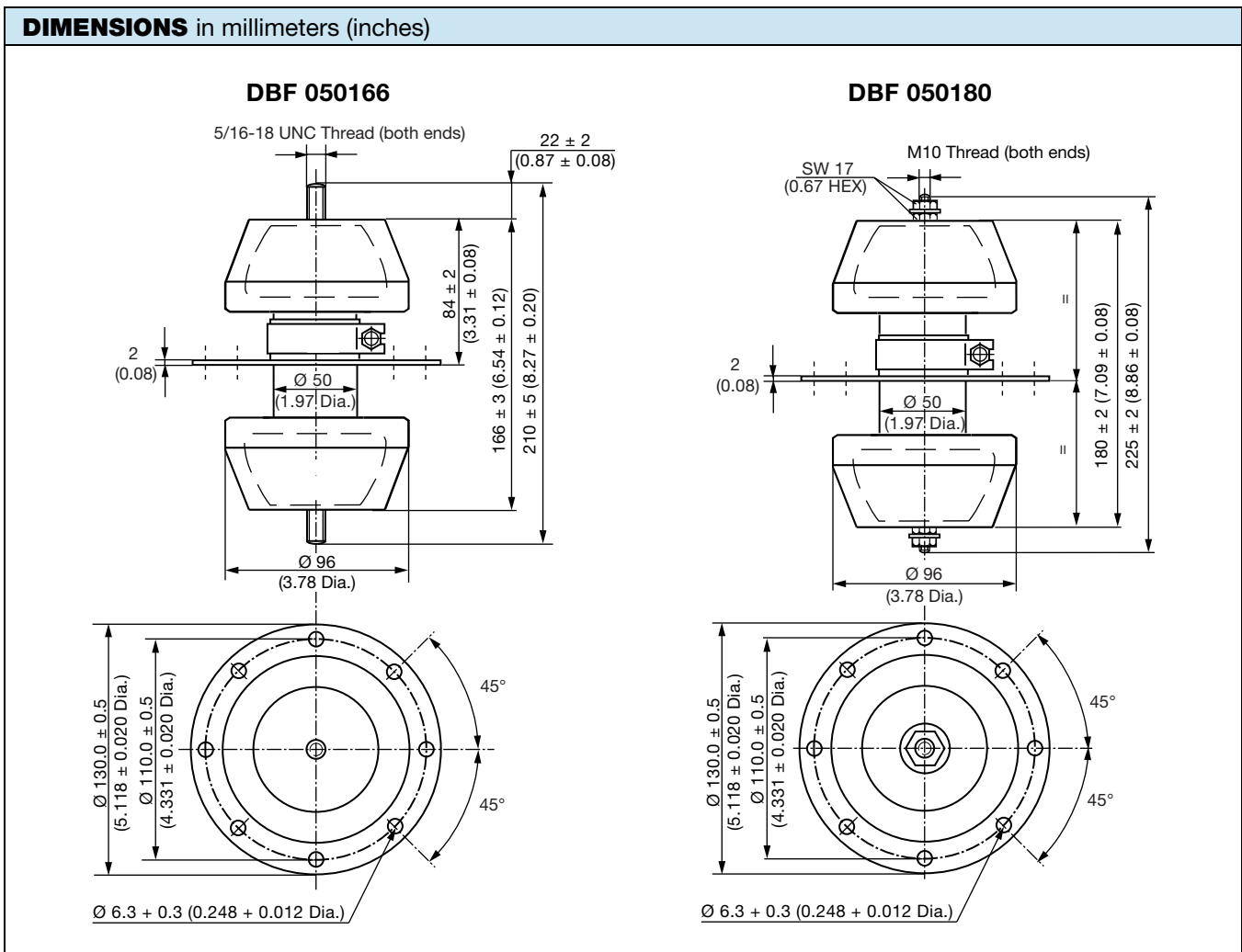

MOUNTING GUIDELINES

- The connection to one electrode must be flexible in order to prevent the generation of physical force which could damage the capacitor elements. Such forces are often generated by the dimensional differences resulting from the normal physical tolerances of these components.
- The capacitor elements must not be used as a mechanical support for other devices or components.
- Use two wrenches when tightening the nuts on both sides of the conductor rod.
The outer electrode terminal flange of these feed-through capacitors components should be fixed after tightening the inner electrode's connection.
- Make sure that not too much force applied to the solder connections between hardware and noble metal electrode. A torque less than 5 Nm is recommended.

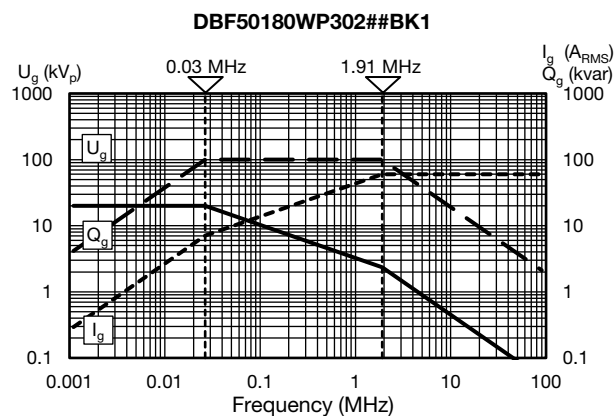
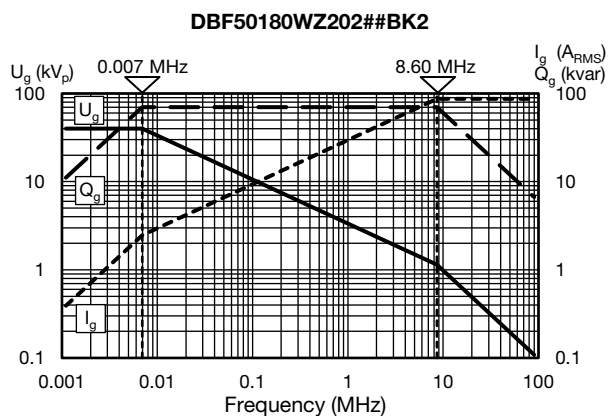
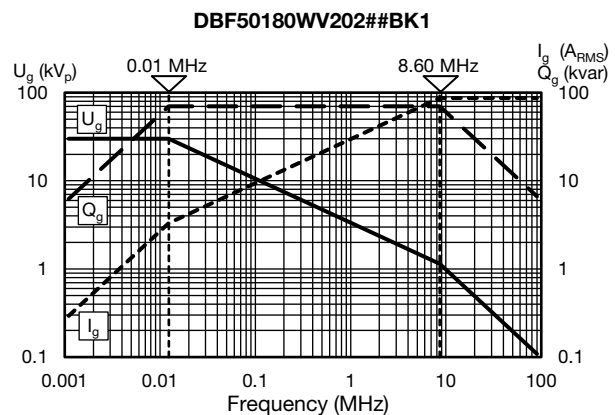
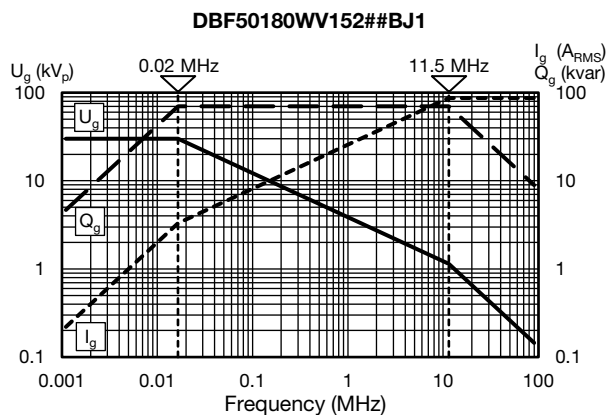
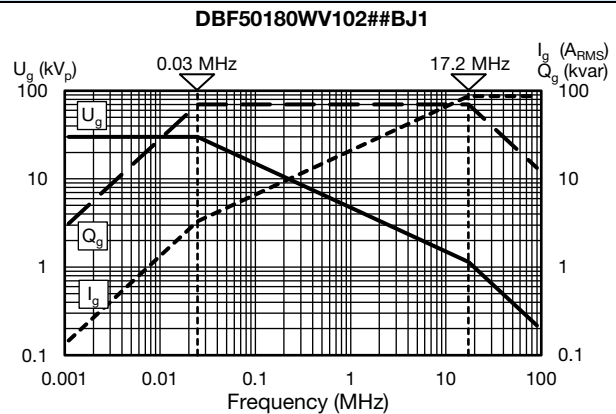
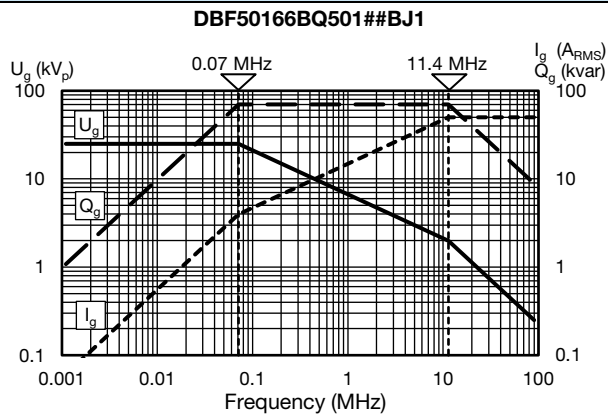
DERATING DIAGRAMS

RELATED DOCUMENTS

General Information

www.vishay.com/doc?22071



Disclaimer

ALL PRODUCT, PRODUCT SPECIFICATIONS AND DATA ARE SUBJECT TO CHANGE WITHOUT NOTICE TO IMPROVE RELIABILITY, FUNCTION OR DESIGN OR OTHERWISE.

Vishay Intertechnology, Inc., its affiliates, agents, and employees, and all persons acting on its or their behalf (collectively, "Vishay"), disclaim any and all liability for any errors, inaccuracies or incompleteness contained in any datasheet or in any other disclosure relating to any product.

Vishay makes no warranty, representation or guarantee regarding the suitability of the products for any particular purpose or the continuing production of any product. To the maximum extent permitted by applicable law, Vishay disclaims (i) any and all liability arising out of the application or use of any product, (ii) any and all liability, including without limitation special, consequential or incidental damages, and (iii) any and all implied warranties, including warranties of fitness for particular purpose, non-infringement and merchantability.

Statements regarding the suitability of products for certain types of applications are based on Vishay's knowledge of typical requirements that are often placed on Vishay products in generic applications. Such statements are not binding statements about the suitability of products for a particular application. It is the customer's responsibility to validate that a particular product with the properties described in the product specification is suitable for use in a particular application. Parameters provided in datasheets and / or specifications may vary in different applications and performance may vary over time. All operating parameters, including typical parameters, must be validated for each customer application by the customer's technical experts. Product specifications do not expand or otherwise modify Vishay's terms and conditions of purchase, including but not limited to the warranty expressed therein.

Hyperlinks included in this datasheet may direct users to third-party websites. These links are provided as a convenience and for informational purposes only. Inclusion of these hyperlinks does not constitute an endorsement or an approval by Vishay of any of the products, services or opinions of the corporation, organization or individual associated with the third-party website. Vishay disclaims any and all liability and bears no responsibility for the accuracy, legality or content of the third-party website or for that of subsequent links.

Except as expressly indicated in writing, Vishay products are not designed for use in medical, life-saving, or life-sustaining applications or for any other application in which the failure of the Vishay product could result in personal injury or death. Customers using or selling Vishay products not expressly indicated for use in such applications do so at their own risk. Please contact authorized Vishay personnel to obtain written terms and conditions regarding products designed for such applications.

No license, express or implied, by estoppel or otherwise, to any intellectual property rights is granted by this document or by any conduct of Vishay. Product names and markings noted herein may be trademarks of their respective owners.