

IPAD™ automotive grade integrated protected low pass filter for BroadR Reach™ interface

Datasheet - production data



Description

The EMIF02-02OABRY is a highly integrated solution designed to suppress EMI noise in BroadR Reach™ interfaces in automotive applications. This low pass filter includes a 15 kV ISO10605 protection and is housed in a 3 x 3 mm² wettable flanks QFN.

Figure 1. EMIF02-02OABRY equivalent circuit

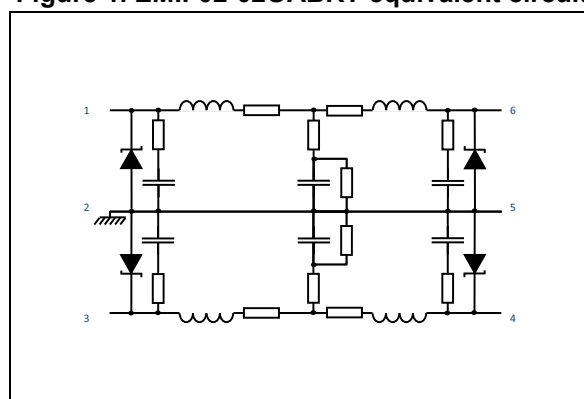

Features

- Attenuation profile compliant with BroadR Reach™ requirements from -40 °C to 125 °C
- Return loss (S_{dd11}) at 60 MHz: -20 dB
- Components matching: 1% (between line 1 and 2)
- Package:
 - Dimensions: 3.0 x 3.0 mm
 - Pitch: 1.1 μm
 - Wettable flank QFN
- AEC-Q101 compliant

Complies with the following standards

- ISO 10605 (330 Ω / 330 pF) (pins 1 and 3):
 - 15 kV (air discharge)
 - 15 kV (contact discharge)
- ISO 7637-3 (pins 1 and 3):
 - Pulse 3a: -150 V
 - Pulse 3b: +100 V
- MIL-STD883J (HBM) (pins 4 and 6)
 - ±2 kV

TM: IPAD is a trademark of STMicroelectronics.

1 Characteristics

Table 1. Absolute ratings ($T_{amb} = 25\text{ }^{\circ}\text{C}$)

Symbol	Parameter and test conditions	Value	Unit
V_{PP}	External pins (pin 1 and pin 3): IEC 61000-4-2 (330 Ω / 150 pF) air discharge contact discharge	± 15 ± 15	kV
	External pins (pin 1 and pin 3): ISO 10605 (330 Ω / 330 pF) air discharge contact discharge	± 15 ± 15	
V_{PP}	Transceiver side pins: HBM (pin 4 and pin 6)	± 2	kV
T_L	Maximum lead temperature for soldering 10 s	260	$^{\circ}\text{C}$
T_{op}	Operating junction temperature range	-40 to +125	$^{\circ}\text{C}$
T_{stg}	Storage temperature range	-55 to +125	$^{\circ}\text{C}$

Table 2. Electrical characteristics ($T_{amb} = 25\text{ }^{\circ}\text{C}$)

Symbol	Conditions	Min.	Typ.	Max.	Unit
V_{BR}	Internal protection diode breakdown voltage, $I_R = 20\text{ mA}$	6			V
V_{CL}	$I_{PP} = 1\text{ A}$, 8/20 μs		10.5		V
R_{DC}	Serial resistance (pins 3 to 4 or 1 to 6)		12		Ω
S_{dd11}	From 10 MHz to 60 MHz, $T_j = -40\text{ }^{\circ}\text{C}$ to $125\text{ }^{\circ}\text{C}$			-20	dB
S_{dd22}				-20	
S_{cd21} S_{dc21}				-50	

Figure 2. BroadR Reach application schematic

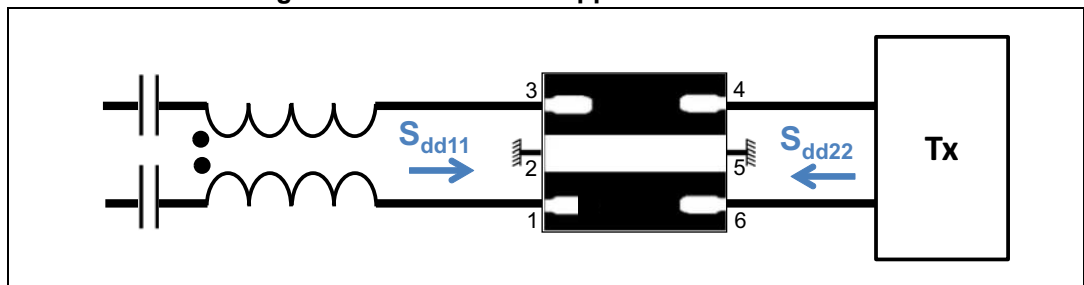

Figure 3. S_{dd11} differential return loss curve -external pins

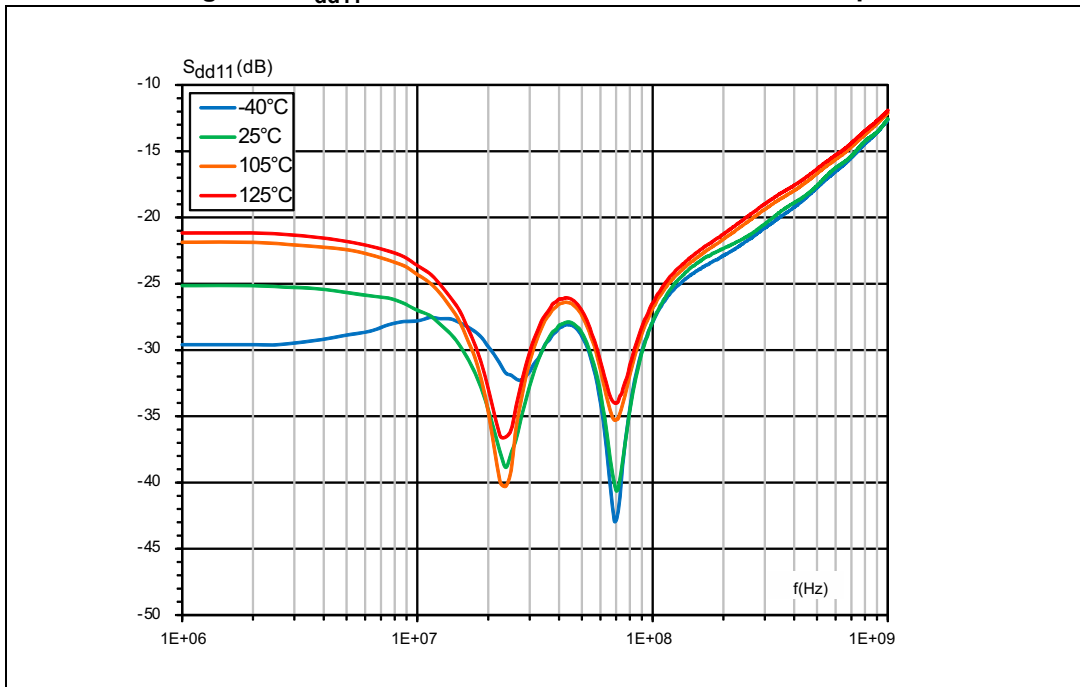

Figure 4. S_{dd22} differential return loss curve -transceiver side pins

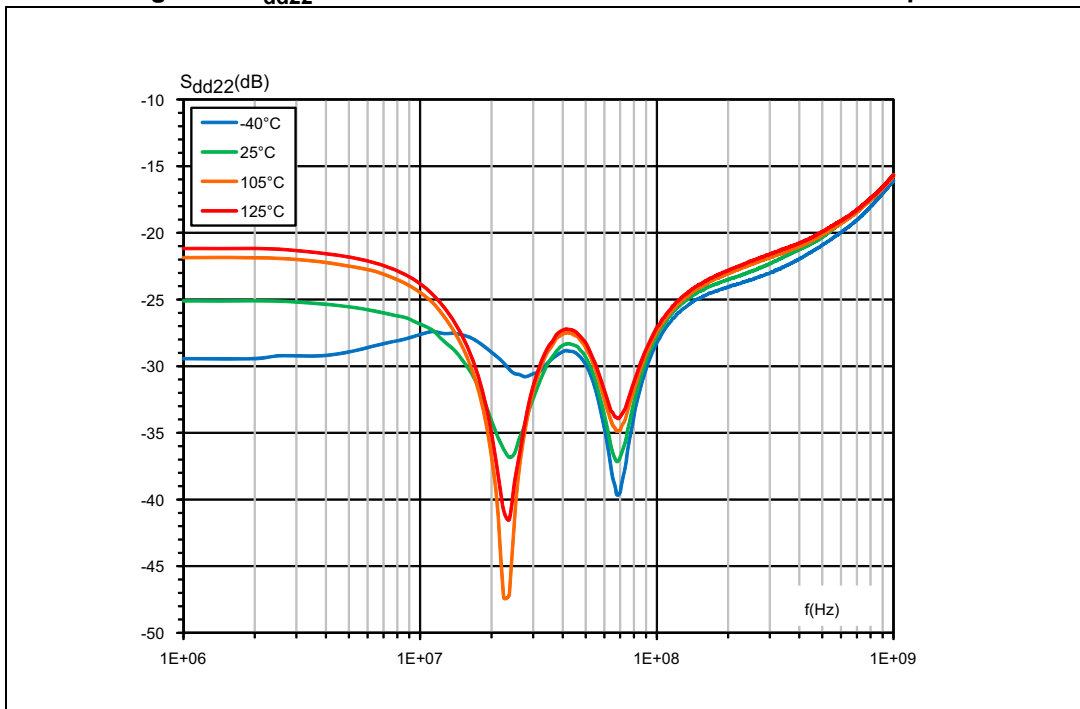

Figure 5. S_{dd21} attenuation curve

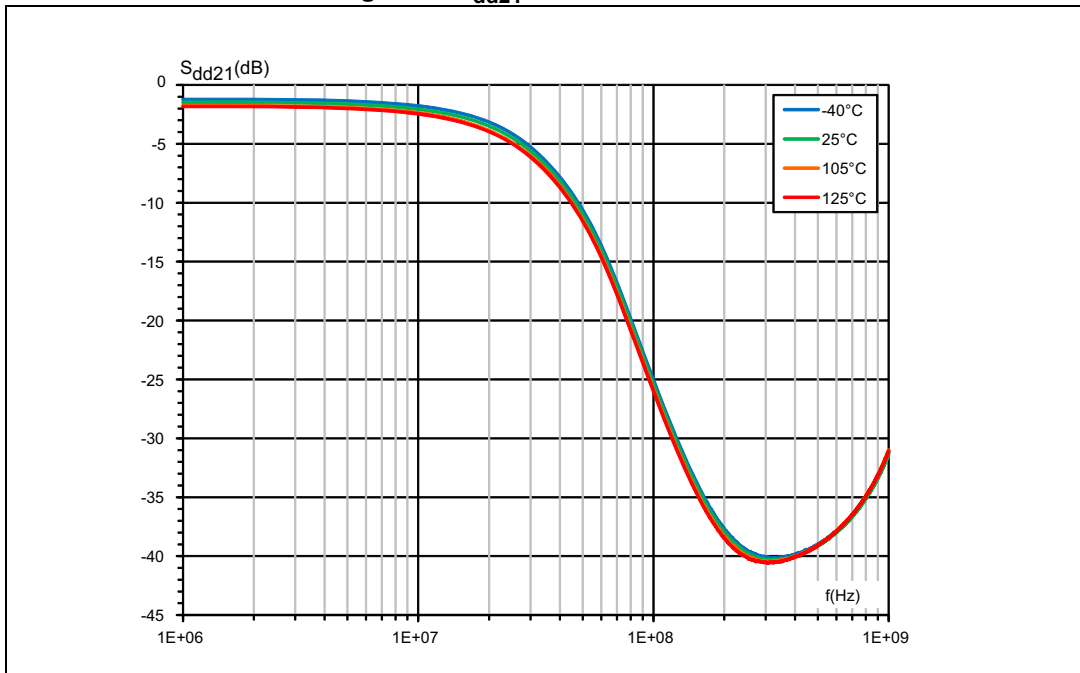

Figure 6. ESD response to ISO 10605-
C = 330 pF, R = 330 Ω (+15 kV contact)

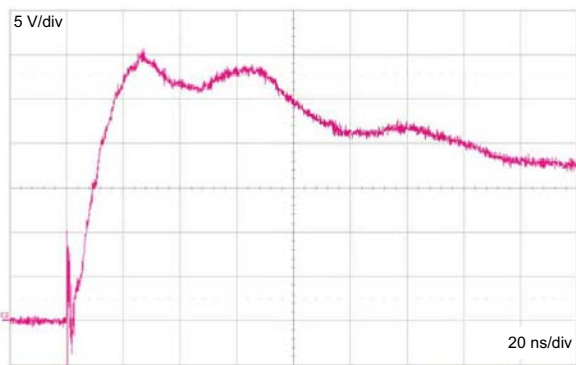

Figure 7. ESD response to ISO 10605-
C = 330 pF, R = 330 Ω (-15 kV contact)

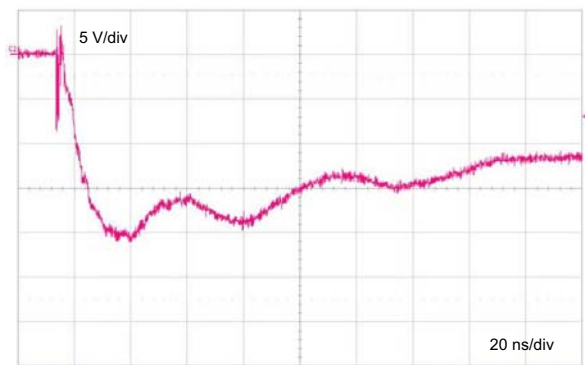

Figure 8. Response to ISO 7637-3 (pulse 3a)
Us = -150 V

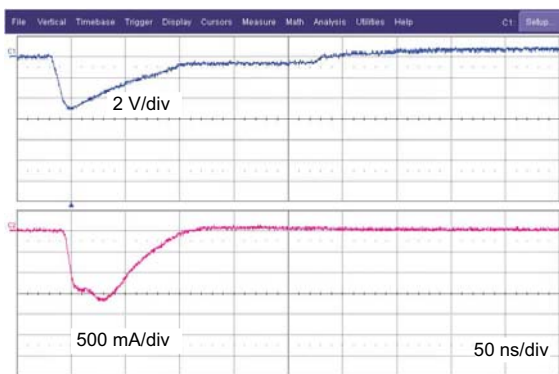
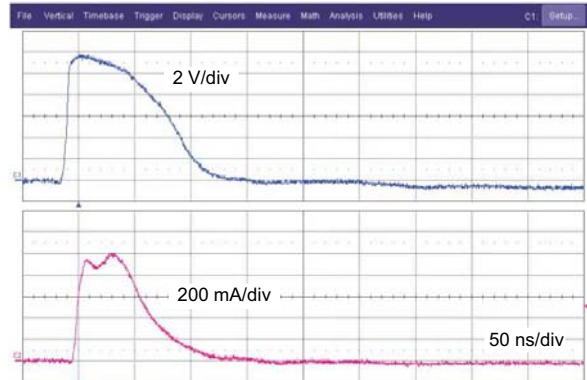

Figure 9. Response to ISO 7637-3 (pulse 3b)
Us = +100 V



2 Package information

In order to meet environmental requirements, ST offers these devices in different grades of ECOPACK[®] packages, depending on their level of environmental compliance. ECOPACK[®] specifications, grade definitions and product status are available at: www.st.com. ECOPACK[®] is an ST trademark.

2.1 QFN package information

Figure 10. QFN package outline

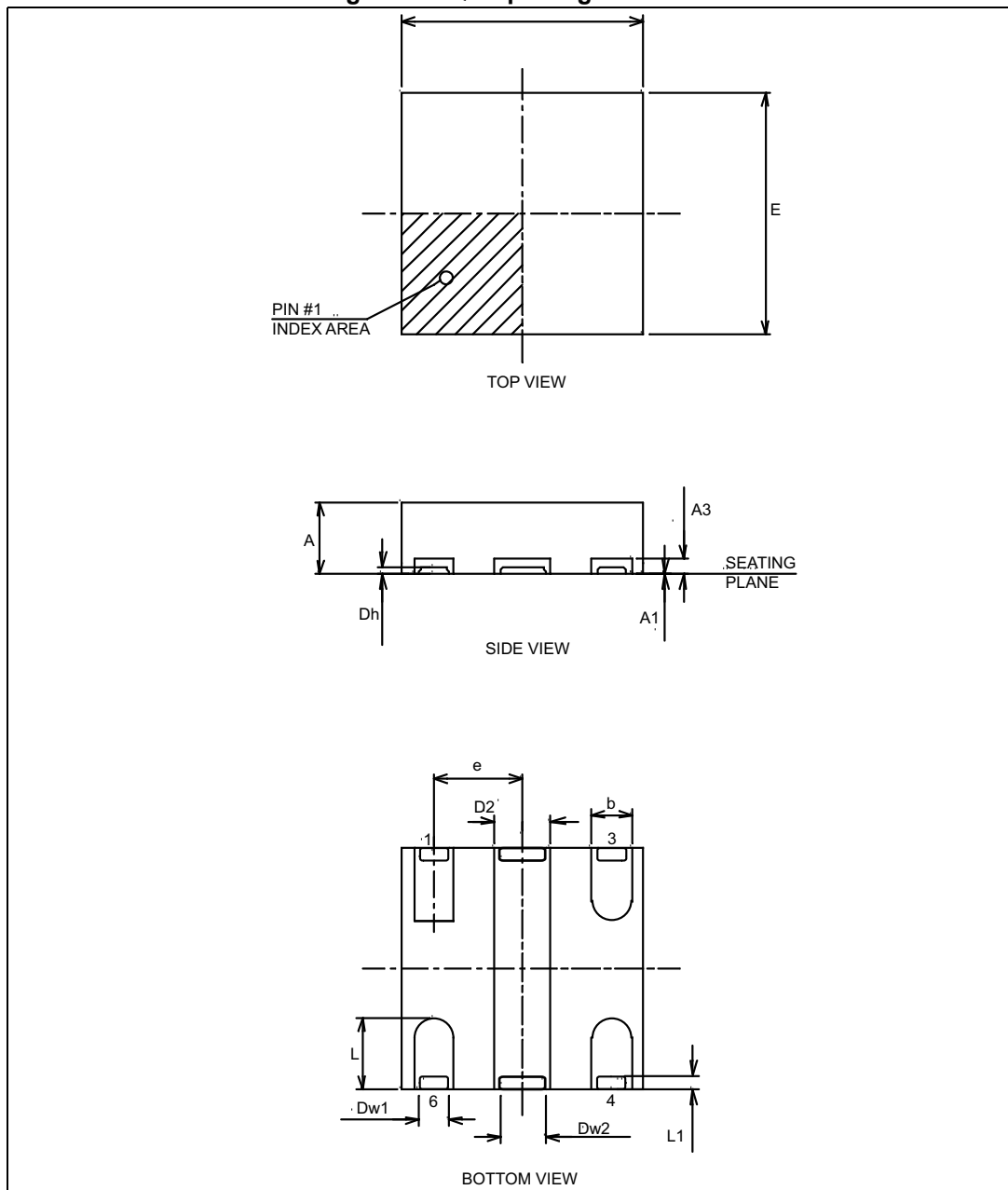

Table 3. QFN package mechanical data

Ref.	Dimensions					
	Millimeters			Inches ⁽¹⁾		
	Min.	Typ.	Max.	Min.	Typ.	Max.
A	0.80	0.85	0.90	0.0315	0.0335	0.0354
A1	0.00	0.02	0.05	0.00	0.0008	0.0020
A3		0.203			0.0080	
b	0.45	0.50	0.55	0.0178	0.0197	0.0217
D	2.95	3.00	3.05	0.1161	0.1181	0.1201
E	2.95	3.00	3.05	0.1161	0.1181	0.1201
e		1.105			0.0436	
L	0.85	0.90	0.95	0.0335	0.0354	0.0374
D2	0.60	0.70	0.80	0.0236	0.0276	0.0315
L1	0.07	0.15	0.23	0.0028	0.0060	0.0091
Dw1	0.30	0.35	0.40	0.0118	0.0138	0.0157
Dh ⁽²⁾	0.10			0.0039		
Dw2 ⁽²⁾	0.50	0.55	0.60	0.0197	0.0217	0.0236

1. Values in inches are converted from mm and rounded to 4 decimal digits.
2. Solder filled dimples

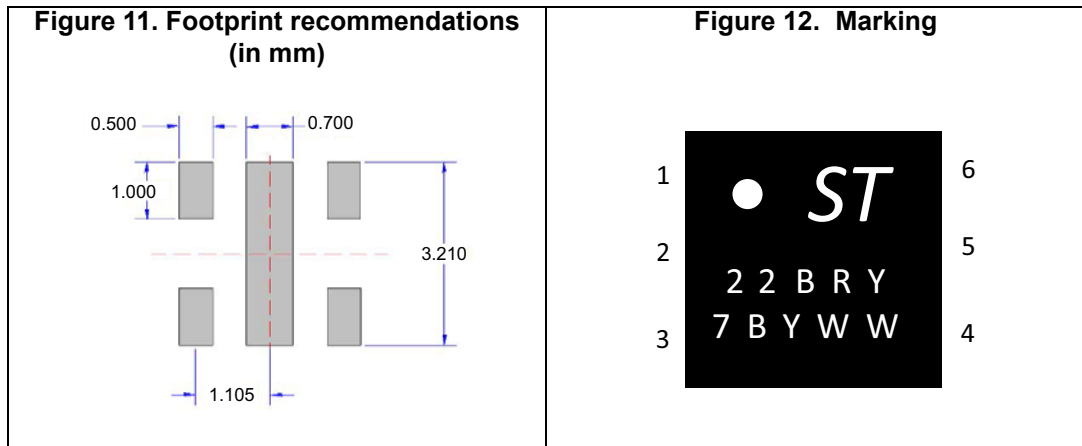
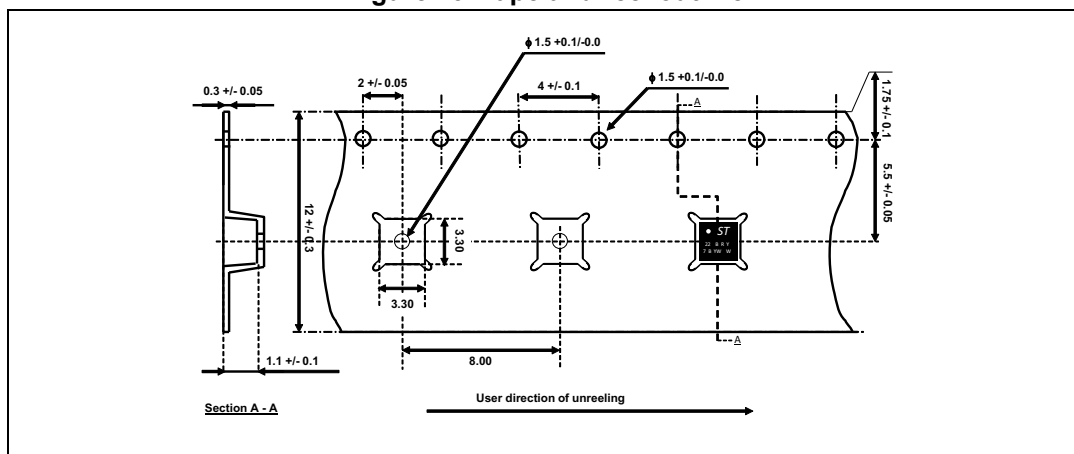

Figure 13. Tape and reel outline



3 Recommendation on PCB assembly

3.1 Reflow profile

Figure 14. ST ECOPACK[®] recommended soldering reflow profile for PCB mounting

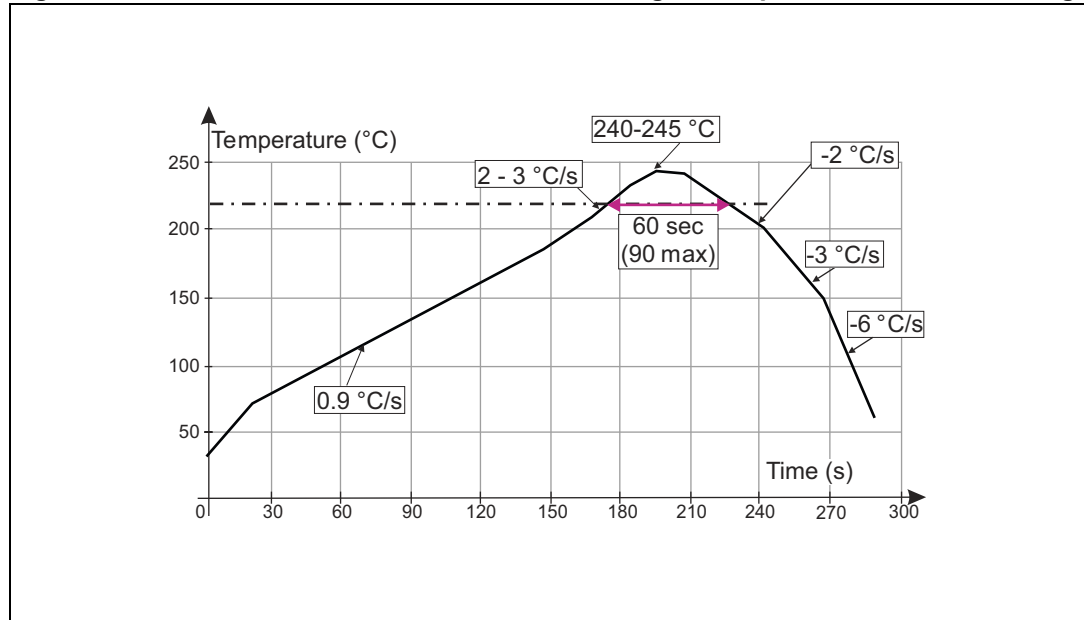

Note: Minimize air convection currents in the reflow oven to avoid component movement. Maximum soldering profile corresponds to the latest IPC/JEDEC J-ST-020.

3.2 Stencil opening design

Figure 15. Recommended stencil window position in mm (inches)

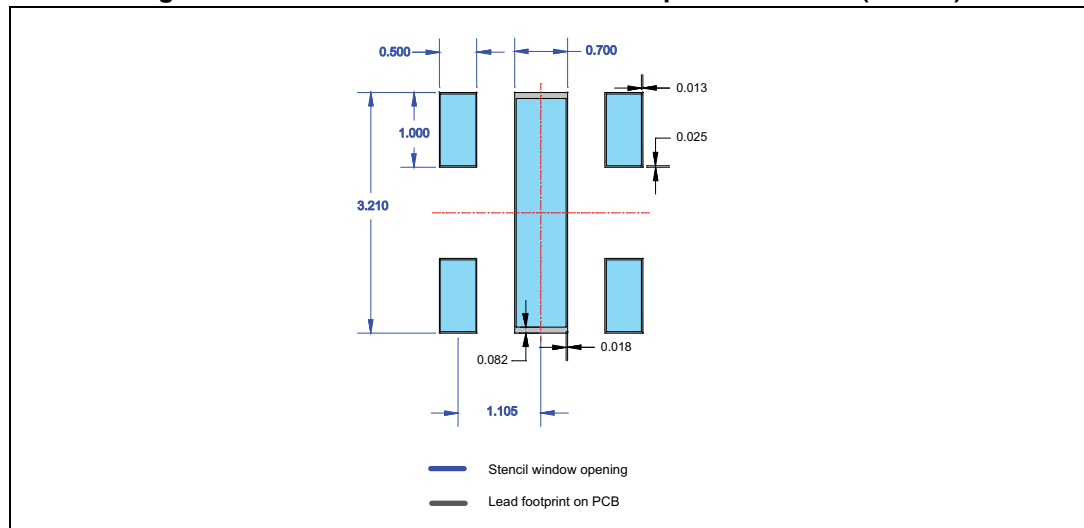

4 Ordering information

Figure 16. Ordering information scheme

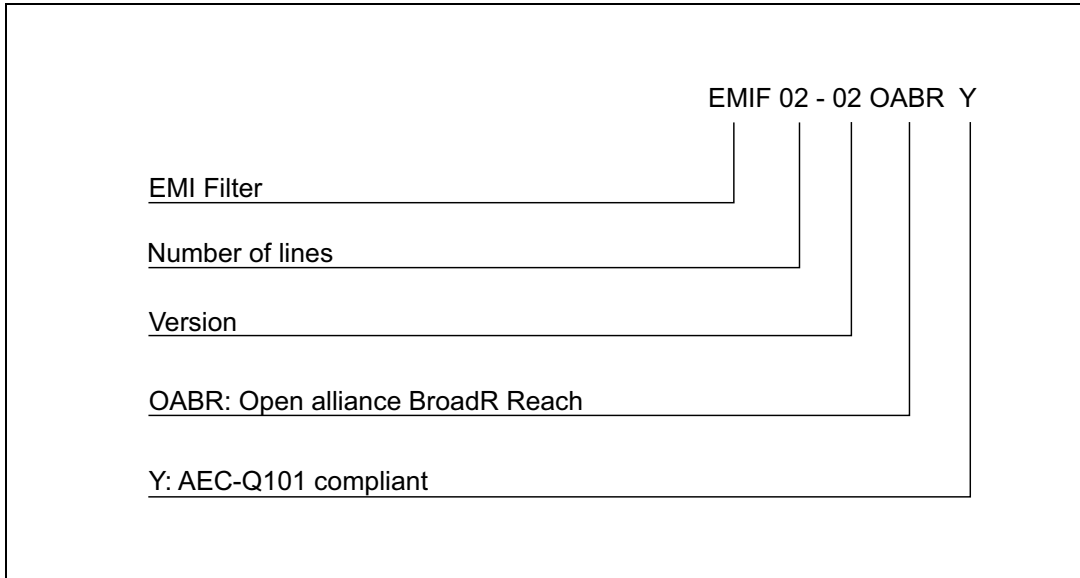

Table 4. Ordering information

Order code	Marking	Package	Weight	Base qty.	Delivery mode
EMIF02-02OABRY	22BRY	QFN 3x3 - 6L- (wetable flank)	22.5 mg	3000	Tape and reel

5 Revision history

Table 5. Document revision history

Date	Revision	Changes
24-Jun-2016	1	Initial release

IMPORTANT NOTICE – PLEASE READ CAREFULLY

STMicroelectronics NV and its subsidiaries (“ST”) reserve the right to make changes, corrections, enhancements, modifications, and improvements to ST products and/or to this document at any time without notice. Purchasers should obtain the latest relevant information on ST products before placing orders. ST products are sold pursuant to ST’s terms and conditions of sale in place at the time of order acknowledgement.

Purchasers are solely responsible for the choice, selection, and use of ST products and ST assumes no liability for application assistance or the design of Purchasers’ products.

No license, express or implied, to any intellectual property right is granted by ST herein.

Resale of ST products with provisions different from the information set forth herein shall void any warranty granted by ST for such product.

ST and the ST logo are trademarks of ST. All other product or service names are the property of their respective owners.

Information in this document supersedes and replaces information previously supplied in any prior versions of this document.

© 2016 STMicroelectronics – All rights reserved

