

## Important notice

Dear Customer,

On 7 February 2017 the former NXP Standard Product business became a new company with the tradename **Nexperia**. Nexperia is an industry leading supplier of Discrete, Logic and PowerMOS semiconductors with its focus on the automotive, industrial, computing, consumer and wearable application markets

In data sheets and application notes which still contain NXP or Philips Semiconductors references, use the references to Nexperia, as shown below.

Instead of <http://www.nxp.com>, <http://www.philips.com/> or <http://www.semiconductors.philips.com/>, use <http://www.nexperia.com>

Instead of [sales.addresses@www.nxp.com](mailto:sales.addresses@www.nxp.com) or [sales.addresses@www.semiconductors.philips.com](mailto:sales.addresses@www.semiconductors.philips.com), use [salesaddresses@nexperia.com](mailto:salesaddresses@nexperia.com) (email)

Replace the copyright notice at the bottom of each page or elsewhere in the document, depending on the version, as shown below:

- © NXP N.V. (year). All rights reserved or © Koninklijke Philips Electronics N.V. (year). All rights reserved

Should be replaced with:

- © **Nexperia B.V. (year). All rights reserved.**

If you have any questions related to the data sheet, please contact our nearest sales office via e-mail or telephone (details via [salesaddresses@nexperia.com](mailto:salesaddresses@nexperia.com)). Thank you for your cooperation and understanding,

Kind regards,

Team Nexperia

# IP3253/IP3254-TTL

Integrated 4-, 6- and 8-channel passive EMI-filter network with high-level ESD protection

Rev. 1 — 5 May 2011

Product data sheet

## 1. Product profile

---

### 1.1 General description

The IP3253/IP3254-TTL family consists of 4-, 6- and 8-channel LC low-pass filter arrays designed to filter unwanted RF signals on the I/O ports of portable communication and computing devices. In addition, the IP3253/IP3254-TTL family incorporates diodes which protect downstream components from ElectroStatic Discharge (ESD) voltages up to  $\pm 15$  kV.

These devices are fabricated using monolithic silicon technology integrating up to 8 inductors and 16 diodes in a 0.4 mm pitch 8-, 12- or 16-pin ultra-thin leadless Quad Flat No-leads (QFN) plastic package.

### 1.2 Features and benefits

- Pb-free, Restriction of Hazardous Substances (RoHS) compliant and free of halogen and antimony (Dark Green compliant)
- 4-, 6- and 8-channel integrated  $\pi$ -type LC filter network
- ESD protection to  $\pm 15$  kV contact discharge according to IEC 61000-4-2, level 4
- ESD protection to  $\pm 30$  kV contact discharge according to MIL-STD-883 (method 3015) Human Body Model (HBM)
- QFN plastic package with 0.4 mm pitch and 0.5 mm height

### 1.3 Applications

- General-purpose ElectroMagnetic Interference (EMI), Radio-Frequency Interference (RFI) filtering and downstream ESD protection for:
  - ◆ Cellular phone and Personal Communication System (PCS) mobile handsets
  - ◆ Cordless telephones
  - ◆ Wireless data (WAN/LAN) systems



**2. Pinning information**

**Table 1. Pinning**

Pin	Description	Simplified outline	Graphic symbol
<b>IP3253CZ8-4-TTL; IP3254CZ8-4-TTL (SOT1166-1)</b>			
1 and 8	filter channel 1	<p>Transparent top view</p>	<p>001aaJ745</p>
2 and 7	filter channel 2		
3 and 6	filter channel 3		
4 and 5	filter channel 4		
ground pad	ground		
<b>IP3253CZ12-6-TTL; IP3254CZ12-6-TTL (SOT1167-1)</b>			
1 and 12	filter channel 1	<p>Transparent top view</p>	<p>001aaJ746</p>
2 and 11	filter channel 2		
3 and 10	filter channel 3		
4 and 9	filter channel 4		
5 and 8	filter channel 5		
6 and 7	filter channel 6		
ground pad	ground		
<b>IP3253CZ16-8-TTL; IP3254CZ16-8-TTL (SOT1168-1)</b>			
1 and 16	filter channel 1	<p>Transparent top view</p>	<p>001aaJ747</p>
2 and 15	filter channel 2		
3 and 14	filter channel 3		
4 and 13	filter channel 4		
5 and 12	filter channel 5		
6 and 11	filter channel 6		
7 and 10	filter channel 7		
8 and 9	filter channel 8		
ground pad	ground		

### 3. Ordering information

Table 2. Ordering information

Type number	Package		Version
	Name	Description	
IP3253CZ8-4-TTL	HUSON8	plastic, thermal enhanced ultra thin small outline package; no leads; 8 terminals; body 1.35 × 1.7 × 0.55 mm	SOT1166-1
IP3253CZ12-6-TTL	HUSON12	plastic, thermal enhanced ultra thin small outline package; no leads; 12 terminals; body 1.35 × 2.5 × 0.55 mm	SOT1167-1
IP3253CZ16-8-TTL	HUSON16	plastic, thermal enhanced ultra thin small outline package; no leads; 16 terminals; body 1.35 × 3.3 × 0.55 mm	SOT1168-1
IP3254CZ8-4-TTL	HUSON8	plastic, thermal enhanced ultra thin small outline package; no leads; 8 terminals; body 1.35 × 1.7 × 0.55 mm	SOT1166-1
IP3254CZ12-6-TTL	HUSON12	plastic, thermal enhanced ultra thin small outline package; no leads; 12 terminals; body 1.35 × 2.5 × 0.55 mm	SOT1167-1
IP3254CZ16-8-TTL	HUSON16	plastic, thermal enhanced ultra thin small outline package; no leads; 16 terminals; body 1.35 × 3.3 × 0.55 mm	SOT1168-1

### 4. Limiting values

Table 3. Limiting values

In accordance with the Absolute Maximum Rating System (IEC 60134).

Symbol	Parameter	Conditions	Min	Max	Unit
$V_{CC}$	supply voltage		-0.5	+5.6	V
$V_{ESD}$	electrostatic discharge voltage	all pins to ground; contact discharge			
		HBM; MIL-STD-883, method 3015	-	±30	kV
		IEC 61000-4-2, level 4	[1] -	±15	kV
$I_{ch}$	channel current (DC)	$T_{amb} = 85\text{ °C}$	-	30	mA
$P_{ch}$	channel power dissipation		-	10	mW
$P_{tot}/pack$	total power dissipation per package	$T_{amb} = 85\text{ °C}$	-	500	mW
$T_{stg}$	storage temperature		-65	+150	°C
$T_{amb}$	ambient temperature		-40	+85	°C

[1] Device tested with 1000 pulses of ±15 kV contact discharges, according to the IEC 61000-4-2 model, far exceeding IEC 61000-4-2 level 4 (8 kV contact discharge).

## 5. Characteristics

**Table 4. Channel characteristics**

$T_{amb} = 25\text{ }^{\circ}\text{C}$  unless otherwise specified.

Symbol	Parameter	Conditions	Min	Typ	Max	Unit
$L_{s(ch)}$	channel series inductance		-	18	-	nH
$C_{ch}$	channel capacitance	for the total channel; $f_i = 100\text{ kHz}$	[1]			
		IP3253CZx-y-TTL	$V_{bias(DC)} = 2.5\text{ V}$	20	25	28.2
		$V_{bias(DC)} = 0\text{ V}$	34	43	48	pF
	IP3254CZx-y-TTL	$V_{bias(DC)} = 2.5\text{ V}$	25	33	40	pF
		$V_{bias(DC)} = 0\text{ V}$	38	50	60	pF
$I_{LR}$	reverse leakage current	per channel; $V_I = 3.5\text{ V}$	-	-	0.1	$\mu\text{A}$
$V_{BR}$	breakdown voltage	positive clamp; $I_I = 1\text{ mA}$	5.8	-	10	V
$V_F$	forward voltage	negative clamp; $I_F = -1\text{ mA}$	-1.5	-	-0.4	V
$R_{(ch-ch)}$	resistance between channels	$V_I = 3.5\text{ V}$	10	-	-	$\text{M}\Omega$
$R_{s(ch)}$	channel series resistance		-	8	-	$\Omega$

[1] Guaranteed by design.

**Table 5. Frequency characteristics**

$T_{amb} = 25\text{ }^{\circ}\text{C}$  unless otherwise specified.

Symbol	Parameter	Conditions	Min	Typ	Max	Unit
$\alpha_{ij}$	insertion loss	$R_{source} = 50\text{ }\Omega$ ; $R_L = 50\text{ }\Omega$ ; $1\text{ GHz} < f_i < 4\text{ GHz}$	-	30	-	dB
$f_{-3dB}$	cut-off frequency	$R_{source} = 50\text{ }\Omega$ ; $R_L = 50\text{ }\Omega$ ; $V_I = 0\text{ V}$				
		IP3253CZx-y-TTL	-	175	-	MHz
		IP3254CZx-y-TTL	-	145	-	MHz
$f_{rolloff}$	roll-off frequency	$R_{source} = 50\text{ }\Omega$ ; $R_L = 50\text{ }\Omega$ ; $V_I = 0\text{ V}$	[1]			
		IP3253CZx-y-TTL	-	350	-	MHz
		IP3254CZx-y-TTL	-	315	-	MHz

[1] Measured at 6 dB attenuation.

## 6. Application information

### 6.1 Insertion loss

The devices are specifically designed as EMI/RFI filters for multichannel interfaces.

The block schematic for measuring insertion loss in a 50 Ω system is shown in [Figure 1](#). An example of the measurement curves for all channels is shown in [Figure 2](#).

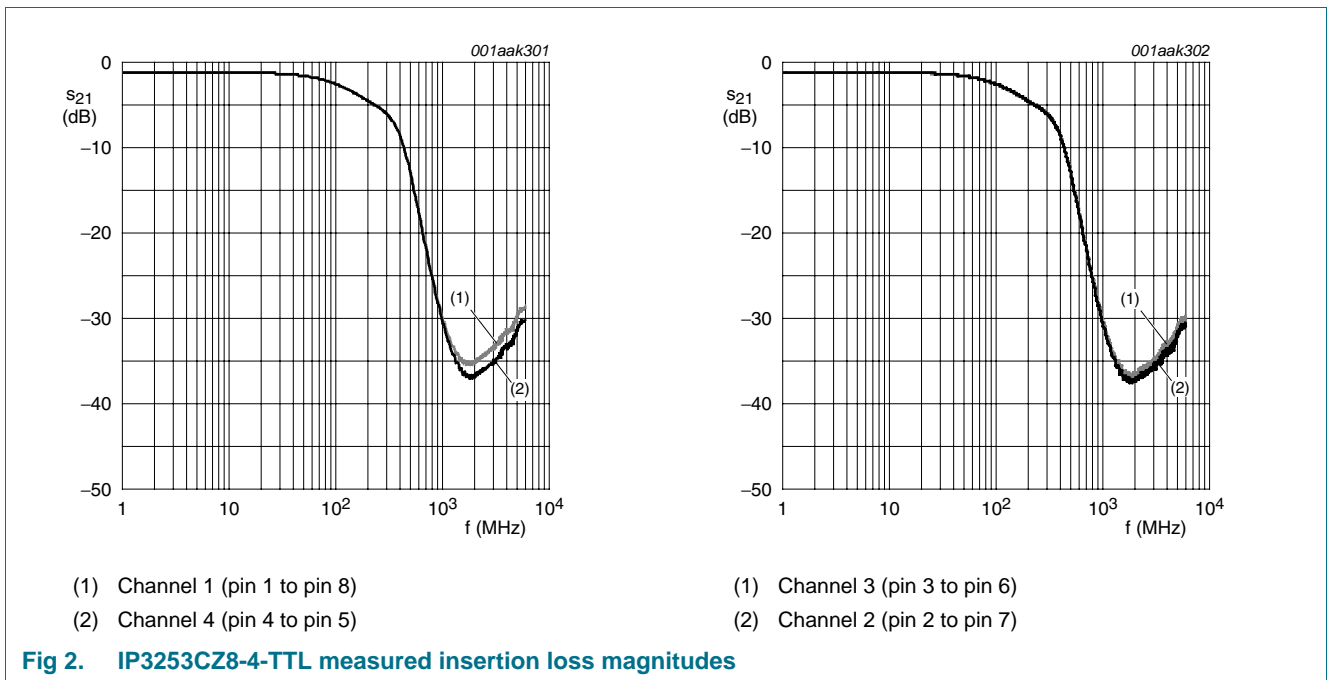
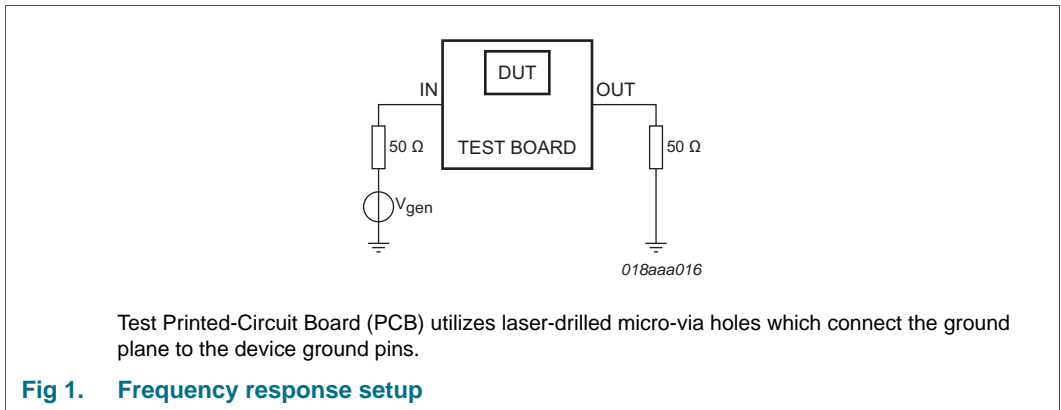

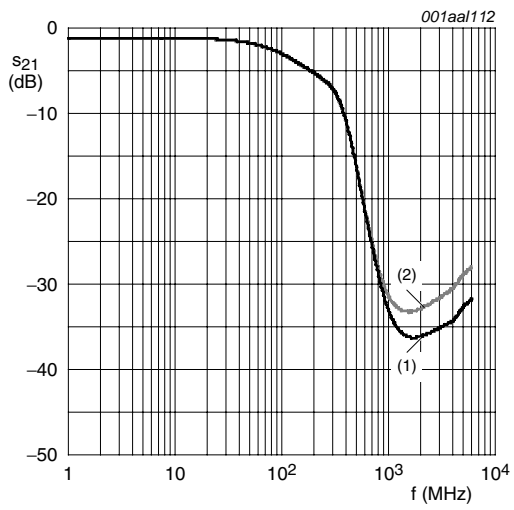

- (1) Channel 1 (pin 1 to pin 8)
- (2) Channel 4 (pin 4 to pin 5)

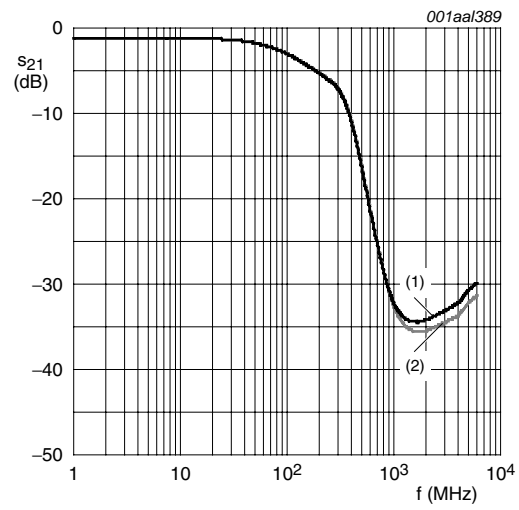

- (1) Channel 3 (pin 3 to pin 6)
- (2) Channel 2 (pin 2 to pin 7)

Fig 3. IP3254CZ8-4-TTL measured insertion loss magnitudes

7. Package outline

HUSON8: plastic, thermal enhanced ultra thin small outline package; no leads; 8 terminals; body 1.35 x 1.7 x 0.55 mm

SOT1166-1

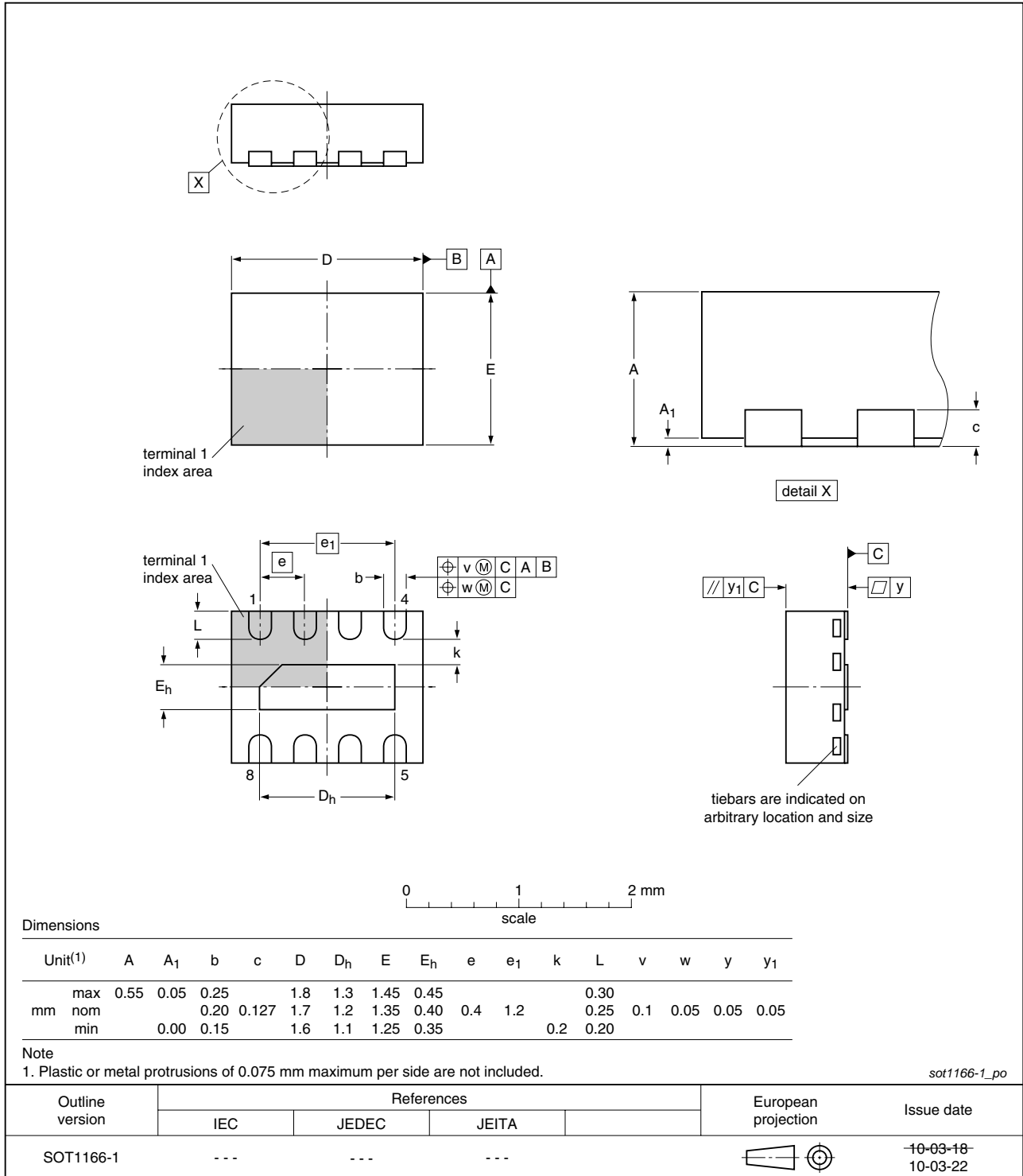

Fig 4. Package outline SOT1166-1 (HUSON8)



HUSON12: plastic, thermal enhanced ultra thin small outline package; no leads; 12 terminals; body 1.35 x 2.5 x 0.55 mm

SOT1167-1

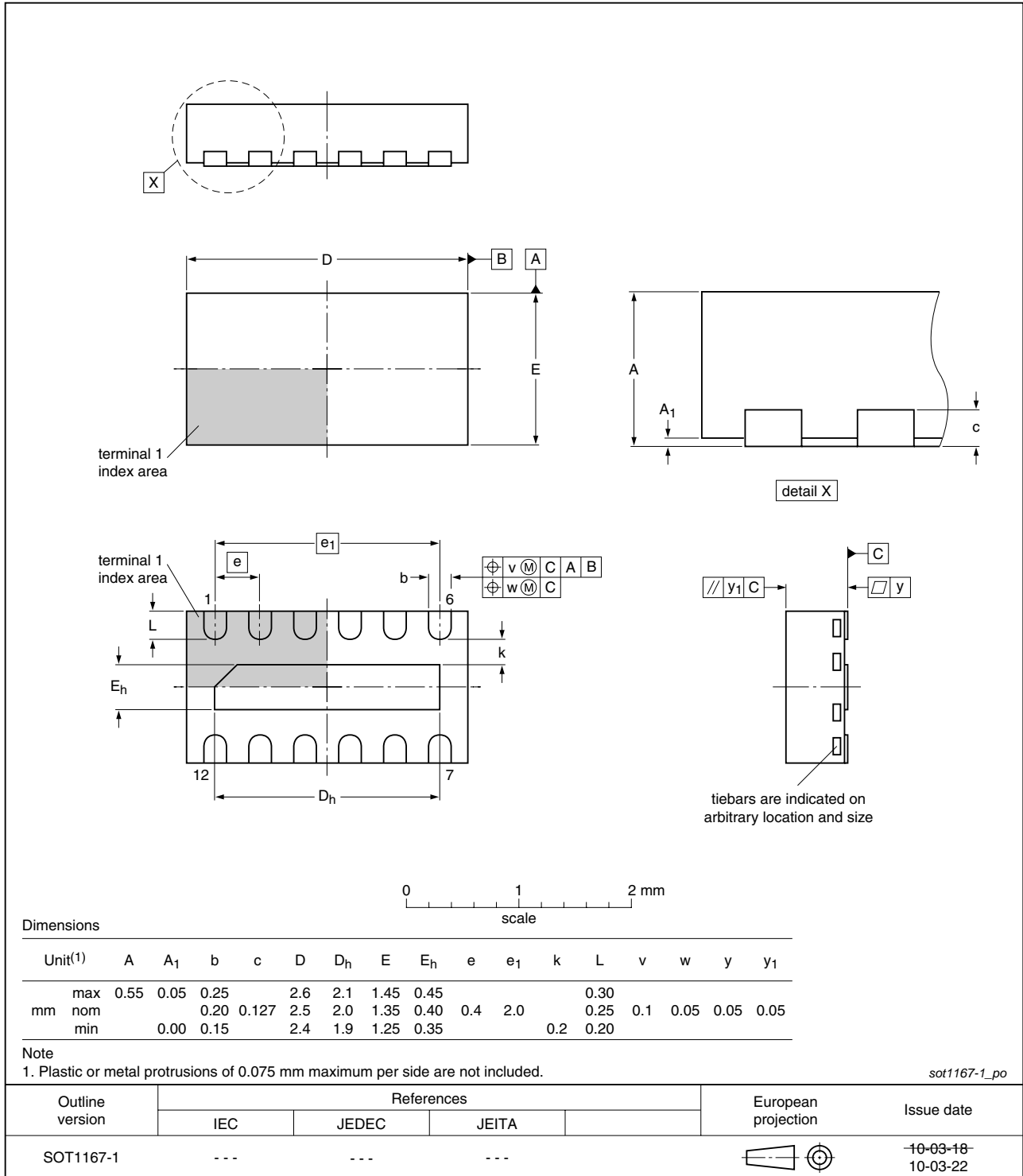

Fig 5. Package outline SOT1167-1 (HUSON12)

HUSON16: plastic, thermal enhanced ultra thin small outline package; no leads; 16 terminals; body 1.35 x 3.3 x 0.55 mm

SOT1168-1

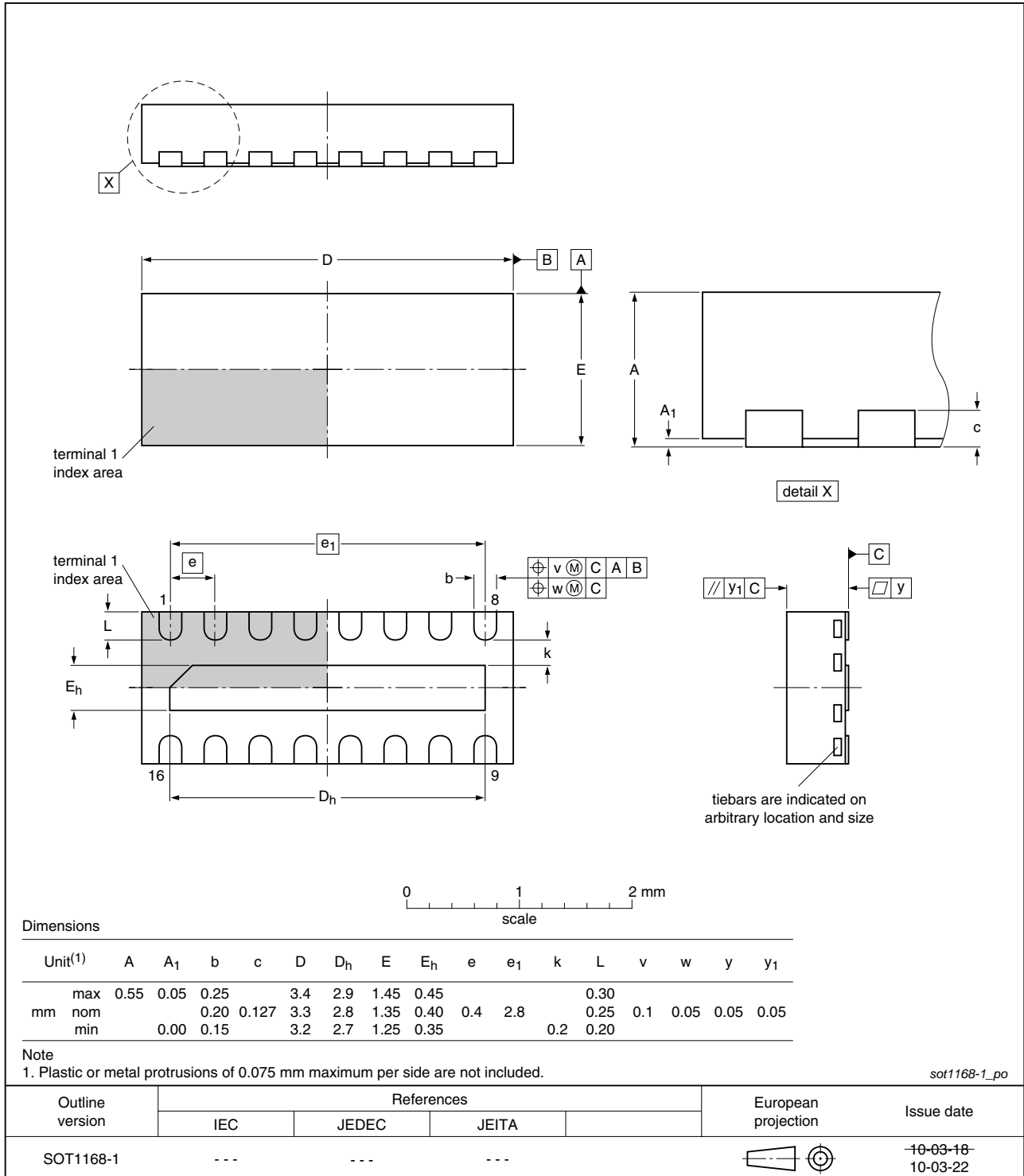

Fig 6. Package outline SOT1168-1 (HUSON16)

## 8. Revision history

Table 6. Revision history

Document ID	Release date	Data sheet status	Change notice	Supersedes
IP3253_IP3254-TTL v.1	20110505	Product data sheet	-	-

## 9. Legal information

### 9.1 Data sheet status

Document status <sup>[1][2]</sup>	Product status <sup>[3]</sup>	Definition
Objective [short] data sheet	Development	This document contains data from the objective specification for product development.
Preliminary [short] data sheet	Qualification	This document contains data from the preliminary specification.
Product [short] data sheet	Production	This document contains the product specification.

[1] Please consult the most recently issued document before initiating or completing a design.

[2] The term 'short data sheet' is explained in section "Definitions".

[3] The product status of device(s) described in this document may have changed since this document was published and may differ in case of multiple devices. The latest product status information is available on the Internet at URL <http://www.nxp.com>.

### 9.2 Definitions

**Draft** — The document is a draft version only. The content is still under internal review and subject to formal approval, which may result in modifications or additions. NXP Semiconductors does not give any representations or warranties as to the accuracy or completeness of information included herein and shall have no liability for the consequences of use of such information.

**Short data sheet** — A short data sheet is an extract from a full data sheet with the same product type number(s) and title. A short data sheet is intended for quick reference only and should not be relied upon to contain detailed and full information. For detailed and full information see the relevant full data sheet, which is available on request via the local NXP Semiconductors sales office. In case of any inconsistency or conflict with the short data sheet, the full data sheet shall prevail.

**Product specification** — The information and data provided in a Product data sheet shall define the specification of the product as agreed between NXP Semiconductors and its customer, unless NXP Semiconductors and customer have explicitly agreed otherwise in writing. In no event however, shall an agreement be valid in which the NXP Semiconductors product is deemed to offer functions and qualities beyond those described in the Product data sheet.

### 9.3 Disclaimers

**Limited warranty and liability** — Information in this document is believed to be accurate and reliable. However, NXP Semiconductors does not give any representations or warranties, expressed or implied, as to the accuracy or completeness of such information and shall have no liability for the consequences of use of such information.

In no event shall NXP Semiconductors be liable for any indirect, incidental, punitive, special or consequential damages (including - without limitation - lost profits, lost savings, business interruption, costs related to the removal or replacement of any products or rework charges) whether or not such damages are based on tort (including negligence), warranty, breach of contract or any other legal theory.

Notwithstanding any damages that customer might incur for any reason whatsoever, NXP Semiconductors' aggregate and cumulative liability towards customer for the products described herein shall be limited in accordance with the *Terms and conditions of commercial sale* of NXP Semiconductors.

**Right to make changes** — NXP Semiconductors reserves the right to make changes to information published in this document, including without limitation specifications and product descriptions, at any time and without notice. This document supersedes and replaces all information supplied prior to the publication hereof.

**Suitability for use** — NXP Semiconductors products are not designed, authorized or warranted to be suitable for use in life support, life-critical or safety-critical systems or equipment, nor in applications where failure or

malfunction of an NXP Semiconductors product can reasonably be expected to result in personal injury, death or severe property or environmental damage. NXP Semiconductors accepts no liability for inclusion and/or use of NXP Semiconductors products in such equipment or applications and therefore such inclusion and/or use is at the customer's own risk.

**Applications** — Applications that are described herein for any of these products are for illustrative purposes only. NXP Semiconductors makes no representation or warranty that such applications will be suitable for the specified use without further testing or modification.

Customers are responsible for the design and operation of their applications and products using NXP Semiconductors products, and NXP Semiconductors accepts no liability for any assistance with applications or customer product design. It is customer's sole responsibility to determine whether the NXP Semiconductors product is suitable and fit for the customer's applications and products planned, as well as for the planned application and use of customer's third party customer(s). Customers should provide appropriate design and operating safeguards to minimize the risks associated with their applications and products.

NXP Semiconductors does not accept any liability related to any default, damage, costs or problem which is based on any weakness or default in the customer's applications or products, or the application or use by customer's third party customer(s). Customer is responsible for doing all necessary testing for the customer's applications and products using NXP Semiconductors products in order to avoid a default of the applications and the products or of the application or use by customer's third party customer(s). NXP does not accept any liability in this respect.

**Limiting values** — Stress above one or more limiting values (as defined in the Absolute Maximum Ratings System of IEC 60134) will cause permanent damage to the device. Limiting values are stress ratings only and (proper) operation of the device at these or any other conditions above those given in the Recommended operating conditions section (if present) or the Characteristics sections of this document is not warranted. Constant or repeated exposure to limiting values will permanently and irreversibly affect the quality and reliability of the device.

**Terms and conditions of commercial sale** — NXP Semiconductors products are sold subject to the general terms and conditions of commercial sale, as published at <http://www.nxp.com/profile/terms>, unless otherwise agreed in a valid written individual agreement. In case an individual agreement is concluded only the terms and conditions of the respective agreement shall apply. NXP Semiconductors hereby expressly objects to applying the customer's general terms and conditions with regard to the purchase of NXP Semiconductors products by customer.

**No offer to sell or license** — Nothing in this document may be interpreted or construed as an offer to sell products that is open for acceptance or the grant, conveyance or implication of any license under any copyrights, patents or other industrial or intellectual property rights.

**Export control** — This document as well as the item(s) described herein may be subject to export control regulations. Export might require a prior authorization from national authorities.

**Non-automotive qualified products** — Unless this data sheet expressly states that this specific NXP Semiconductors product is automotive qualified, the product is not suitable for automotive use. It is neither qualified nor tested in accordance with automotive testing or application requirements. NXP Semiconductors accepts no liability for inclusion and/or use of non-automotive qualified products in automotive equipment or applications.

In the event that customer uses the product for design-in and use in automotive applications to automotive specifications and standards, customer (a) shall use the product without NXP Semiconductors' warranty of the product for such automotive applications, use and specifications, and (b) whenever customer uses the product for automotive applications beyond

NXP Semiconductors' specifications such use shall be solely at customer's own risk, and (c) customer fully indemnifies NXP Semiconductors for any liability, damages or failed product claims resulting from customer design and use of the product for automotive applications beyond NXP Semiconductors' standard warranty and NXP Semiconductors' product specifications.

## 9.4 Trademarks

Notice: All referenced brands, product names, service names and trademarks are the property of their respective owners.

## 10. Contact information

For more information, please visit: <http://www.nxp.com>

For sales office addresses, please send an email to: [salesaddresses@nxp.com](mailto:salesaddresses@nxp.com)

**11. Contents**

<b>1</b>	<b>Product profile</b> .....	<b>1</b>
1.1	General description .....	1
1.2	Features and benefits .....	1
1.3	Applications .....	1
<b>2</b>	<b>Pinning information</b> .....	<b>2</b>
<b>3</b>	<b>Ordering information</b> .....	<b>3</b>
<b>4</b>	<b>Limiting values</b> .....	<b>3</b>
<b>5</b>	<b>Characteristics</b> .....	<b>4</b>
<b>6</b>	<b>Application information</b> .....	<b>5</b>
6.1	Insertion loss .....	5
<b>7</b>	<b>Package outline</b> .....	<b>7</b>
<b>8</b>	<b>Revision history</b> .....	<b>10</b>
<b>9</b>	<b>Legal information</b> .....	<b>11</b>
9.1	Data sheet status .....	11
9.2	Definitions .....	11
9.3	Disclaimers .....	11
9.4	Trademarks .....	12
<b>10</b>	<b>Contact information</b> .....	<b>12</b>
<b>11</b>	<b>Contents</b> .....	<b>13</b>

Please be aware that important notices concerning this document and the product(s) described herein, have been included in section 'Legal information'.

© NXP B.V. 2011.

**All rights reserved.**

For more information, please visit: <http://www.nxp.com>

For sales office addresses, please send an email to: [salesaddresses@nxp.com](mailto:salesaddresses@nxp.com)

Date of release: 5 May 2011

Document identifier: IP3253\_IP3254-TTL