

CM6205

EMI Filters with ESD Protection for Audio

Description

The CM6205 is a 3x2, 5-bump EMI filter with ESD protection device for an audio interface in a CSP form factor, 0.4 mm pitch. The CM6205 is fully compliant with IEC 61000-4-2 and is also RoHS II compliant.

Features

- This Device is Pb-Free, Halogen Free/BFR Free and is RoHS Compliant

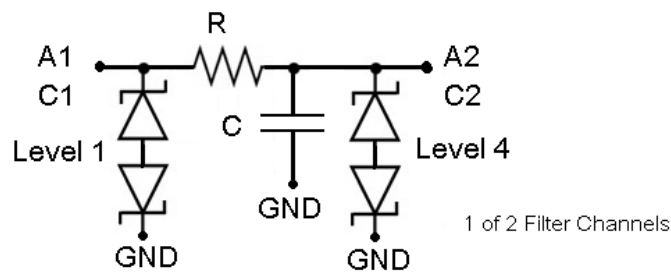

B2 is ground pin.

Figure 1. Electrical Schematic



ON Semiconductor®

<http://onsemi.com>



WLCSP-5
CASE 567CC

PACKAGE PINOUT

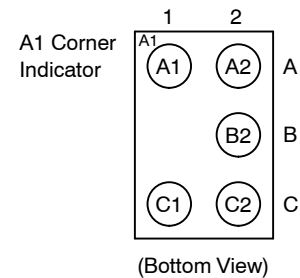

MARKING DIAGRAM

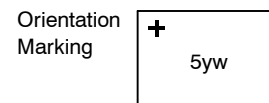

5 = CM6205
yw = Date Code

ORDERING INFORMATION

See detailed ordering and shipping information in the package dimensions section on page 5 of this data sheet.

CM6205

Pin Information

Table 1. PIN DESCRIPTIONS

Pin	Description	Pin	Description
A1	Channel 1 Internal	A2	Channel 1 External
		B2	GND
C1	Channel 2 Internal	C2	Channel 2 External

Electrical Specifications and Conditions

Table 2. PARAMETERS AND OPERATING CONDITIONS

Parameter	Rating	Units
Storage Temperature Range	-55 to +150	°C
Operating Temperature Range	-40 to +85	°C
Power Dissipation per Channel	100	mW

Table 3. ELECTRICAL OPERATING CHARACTERISTICS (Note 1)

Symbol	Parameter	Conditions	Min	Typ	Max	Units
R ₁ , R ₂	Resistance		13.5	15	16.5	Ω
C ₁ , C ₂	Pin Capacitance	At 1 MHz, V _{IN} = 0 V	4	5	6	nF
I _{LEAK}	Leakage Current per Channel	V _{IN} = 5 V, other pins floating		1.0	100	nA
V _{BR}	Breakdown Voltage (Positive)	I _R = +1 mA	14			V
	Breakdown Voltage (Negative)	I _R = -1 mA			-14	V
V _{ESD}	ESD Protection Peak Discharge Voltage at A2 and C2 pins a) Contact discharge per IEC 61000-4-2 standard b) Air discharge per IEC 61000-4-2 standard	(Note 2)	±15			kV
	ESD Protection Peak Discharge Voltage at A1 and C1 pins a) Contact discharge per IEC 61000-4-2 standard b) Air discharge per IEC 61000-4-2 standard	(Note 2)	±2			kV

1. All parameters specified at T_A = 25°C unless otherwise noted.
2. Standard IEC 61000-4-2 with C_{Discharge} = 150 pF, R_{Discharge} = 330 Ω.

Performance Information

Frequency Response – Filters 1 & 2, RF probes

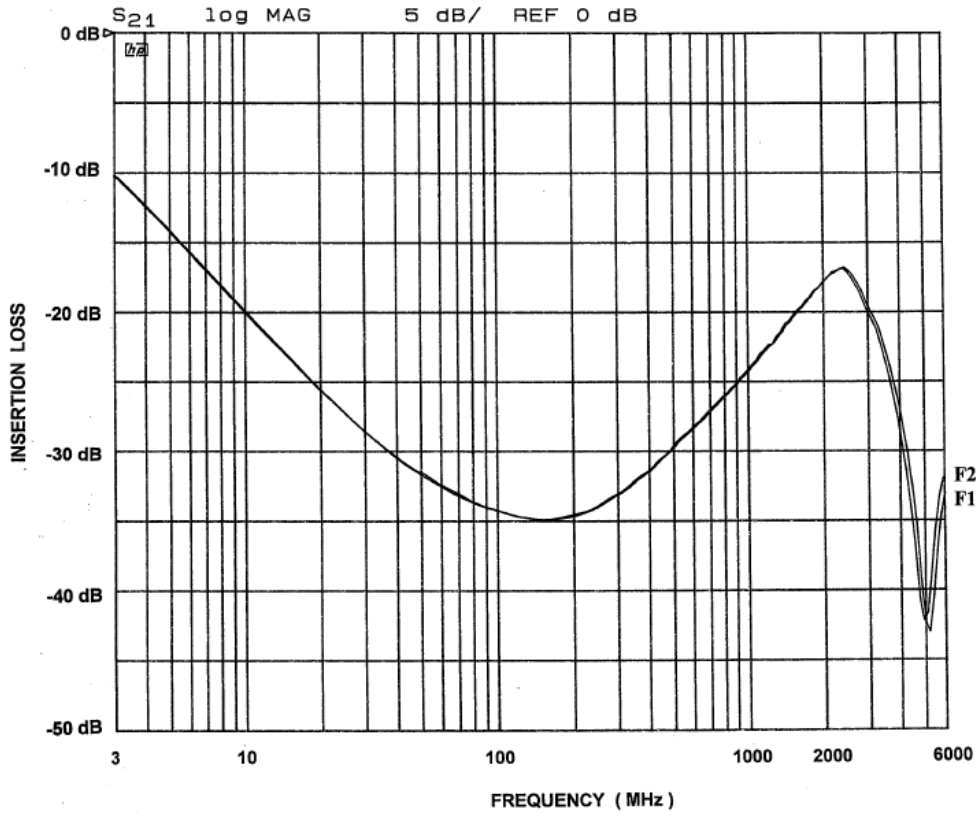

Figure 2. Typical Insertion Loss (Bias = 0 V, $T_A = 25^\circ\text{C}$; 50 Ω Environment)

CM6205

Vertical Structure Specification*

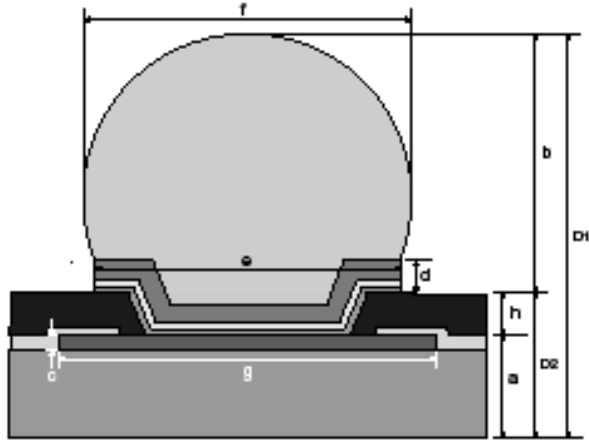

Figure 3. Sectional View

VERTICAL STRUCTURE DIMENSIONS (nominal)

Ref.	Parameter	Material	Dimension
a	Die Thickness	Silicon	396 μm
h	Repassivation	Polyimide	10 μm
d	UBM-(Ti/Cu)	Plated Cu	7.0 μm
		Sputtered Cu	0.4 μm
		Sputtered Ti	0.1 μm
e	UBM Wetting Area Diameter		240 μm
b	Bump Standoff		194 μm
f	Solder Bump Diameter after Bump Reflow		270 μm
c	Metal Pad Height	AlSiCu	1.5 μm
g	Metal Pad Diameter		284 μm
D2			0.406 mm
D1	Finished Thickness		0.600 mm

*Daisy Chain CM6004

Table 4. CSP TAPE AND REEL SPECIFICATIONS †

Part Number	Chip Size (mm)	Pocket Size (mm) $B_0 \times A_0 \times K_0$	Tape Width W	Reel Dia.	Qty Per Reel	P_0	P_1
CM6205	1.20 X 0.80 X 0.60	1.35 X 0.95 X 0.70	8 mm	178 mm (7")	5000	4 mm	4 mm

†For information on tape and reel specifications, including part orientation and tape sizes, please refer to our Tape and Reel Packaging Specification Brochure, BRD8011/D.

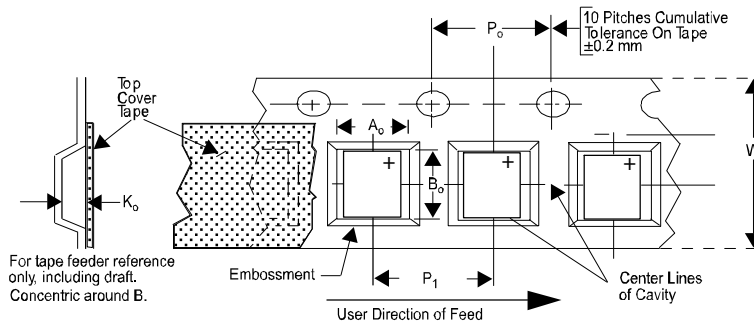
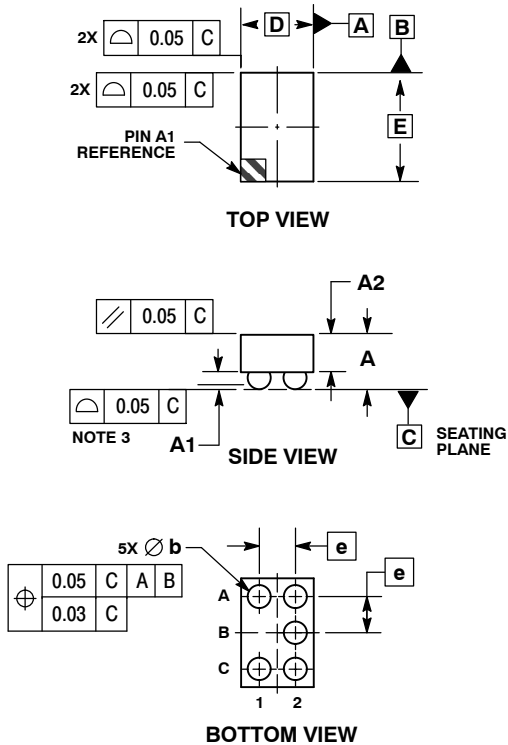

Figure 4. Tape and Reel Mechanical Data

CM6205

PACKAGE DIMENSIONS

WLCSP5, 0.80x1.20
CASE 567CC-01
ISSUE O



NOTES:

1. DIMENSIONING AND TOLERANCING PER ASME Y14.5M, 1994.
2. CONTROLLING DIMENSION: MILLIMETERS.
3. COPLANARITY APPLIES TO SPHERICAL CROWNS OF SOLDER BALLS.

DIM	MILLIMETERS	
	MIN	MAX
A	0.57	0.63
A1	0.17	0.24
A2	0.41 REF	
b	0.24	0.29
D	0.80 BSC	
E	1.20 BSC	
e	0.40 BSC	

RECOMMENDED SOLDERING FOOTPRINT*

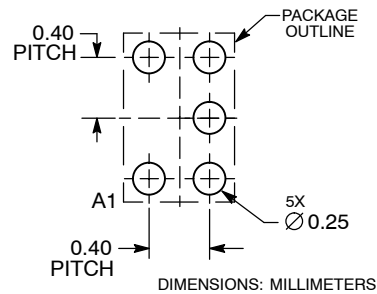

*For additional information on our Pb-Free strategy and soldering details, please download the ON Semiconductor Soldering and Mounting Techniques Reference Manual, SOLDERRM/D.

Ordering Information

Table 5. PART NUMBERING INFORMATION

Bumps	Package	Ordering Part Number (Note 3)	Part Marking (Date Code)
5	CSP-SAC105	CM6205	5yw

3. Parts are shipped in Tape and Reel form unless otherwise specified.

ON Semiconductor and are registered trademarks of Semiconductor Components Industries, LLC (SCILLC). SCILLC reserves the right to make changes without further notice to any products herein. SCILLC makes no warranty, representation or guarantee regarding the suitability of its products for any particular purpose, nor does SCILLC assume any liability arising out of the application or use of any product or circuit, and specifically disclaims any and all liability, including without limitation special, consequential or incidental damages. "Typical" parameters which may be provided in SCILLC data sheets and/or specifications can and do vary in different applications and actual performance may vary over time. All operating parameters, including "Typicals" must be validated for each customer application by customer's technical experts. SCILLC does not convey any license under its patent rights nor the rights of others. SCILLC products are not designed, intended, or authorized for use as components in systems intended for surgical implant into the body, or other applications intended to support or sustain life, or for any other application in which the failure of the SCILLC product could create a situation where personal injury or death may occur. Should Buyer purchase or use SCILLC products for any such unintended or unauthorized application, Buyer shall indemnify and hold SCILLC and its officers, employees, subsidiaries, affiliates, and distributors harmless against all claims, costs, damages, and expenses, and reasonable attorney fees arising out of, directly or indirectly, any claim of personal injury or death associated with such unintended or unauthorized use, even if such claim alleges that SCILLC was negligent regarding the design or manufacture of the part. SCILLC is an Equal Opportunity/Affirmative Action Employer. This literature is subject to all applicable copyright laws and is not for resale in any manner.

PUBLICATION ORDERING INFORMATION

LITERATURE FULFILLMENT:
Literature Distribution Center for ON Semiconductor
P.O. Box 5163, Denver, Colorado 80217 USA
Phone: 303-675-2175 or 800-344-3860 Toll Free USA/Canada
Fax: 303-675-2176 or 800-344-3867 Toll Free USA/Canada
Email: orderlit@onsemi.com

N. American Technical Support: 800-282-9855 Toll Free USA/Canada
Europe, Middle East and Africa Technical Support:
Phone: 421 33 790 2910
Japan Customer Focus Center
Phone: 81-3-5773-3850

ON Semiconductor Website: www.onsemi.com
Order Literature: <http://www.onsemi.com/orderlit>

For additional information, please contact your local Sales Representative