



# Headset/Speaker EMI Filter with ESD Protection

## CM1416

### Features

- Functionally and pin compatible with the CSPEMI201A and CM1411
- *OptiGuard*<sup>™</sup> coated for improved reliability at assembly
- Two channels of EMI filtering for 8Ω speakers
- Pi-style EMI filters in a capacitor-resistor-capacitor (C-R-C) network
- Greater than 30dB attenuation at 1GHz
- ±30kV ESD protection on each channel per IEC 61000-4-2 Level 4, contact discharge
- Extremely low lead inductance for optimum filter and ESD performance
- 5-bump, 0.96mm X 1.33mm footprint Chip Scale Package (CSP)
- RoHS-compliant, lead-free finishing

### Applications

- Headset Speaker port in mobile handsets
- I/O port protection for mobile handsets, notebook computers, PDAs etc.
- EMI filtering for data ports in cell phones, PDAs or notebook computers.

### Product Description

The CM1416 is an EMI filter array with ESD protection, which integrates two Pi-filters (C-R-C). The CM1416 has component values of 117pF-2Ω-117pF. The parts include avalanche-type ESD diodes on every pin, which provide a very high level of protection for sensitive electronic components that may be subjected to electrostatic discharge (ESD). The ESD diodes safely dissipate ESD strikes of ±30kV, exceeding the maximum requirement of the IEC 61000-4-2 international standard. Using the MIL-STD-883 (Method 3015) specification for Human Body Model (HBM) ESD, these devices protect for contact discharges at greater than ±30kV.

This device is well suited for portable electronics (e.g. mobile handsets, PDAs, notebook computers) because of its small package and easy-to-use pin assignments. In particular, the CM1416 is ideal for filtering unwanted EMI-induced noise and providing ESD protection for headset speaker port applications in wireless handsets with 8Ω speakers.

The CM1416 incorporates *OptiGuard*<sup>™</sup> coating which results in improved reliability at assembly. The CM1416 is available in a space saving, low profile Chip Scale Package with RoHS-compliant, lead-free finishing.

### Block Diagram

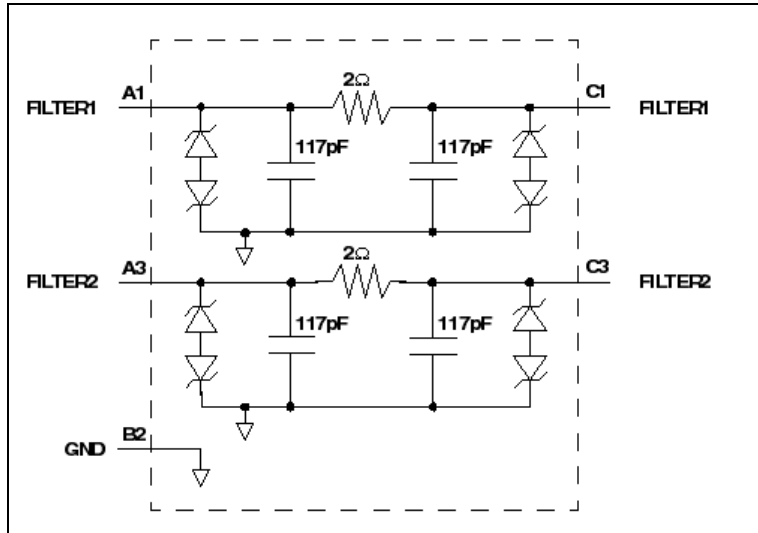

### PACKAGE / PINOUT DIAGRAMS

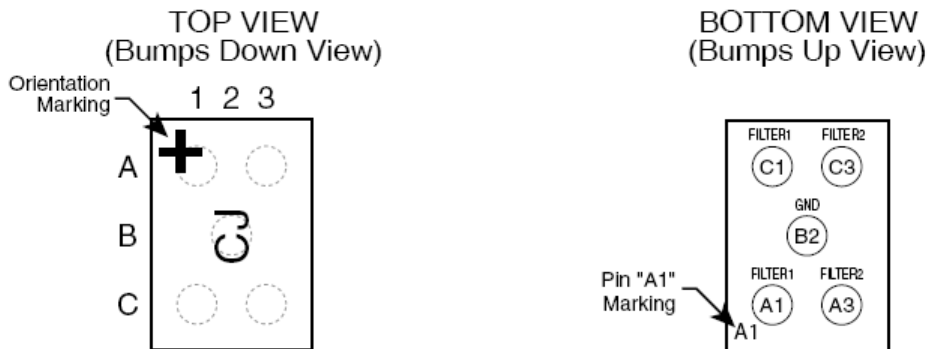

CM1416  
5 Bump CSP Package

Notes:  
1) These drawings are not to scale.

CM1416

### PIN DESCRIPTIONS

PIN	NAME	DESCRIPTION
A1	FILTER1	EMI Filter 1
A3	FILTER2	EMI Filter 2
B2	GND	Device Ground
C1	FILTER1	EMI Filter 1
C3	FILTER2	EMI Filter 2

### Ordering Information

#### PART NUMBERING INFORMATION

Pins	Package	Lead-free Finish	
		Ordering Part Number <sup>1</sup>	Part Marking
5	CSP	CM1416-03CP	CJ

Note 1: Parts are shipped in Tape & Reel form unless otherwise specified.

### Specifications

#### ABSOLUTE MAXIMUM RATINGS

PARAMETER	RATING	UNITS
Storage Temperature Range	-65 to +150	°C
DC Power per Resistor (note 5)	100	mW
DC Package Power Rating (note 5)	500	mW

#### STANDARD OPERATING CONDITIONS

PARAMETER	RATING	UNITS
Operating Temperature Range	-40 to +85	°C

**ELECTRICAL OPERATING CHARACTERISTICS** (SEE NOTE 1)

SYMBOL	PARAMETER	CONDITIONS	MIN	TYP	MAX	UNITS
R	R1 Resistance			2		$\Omega$
C <sub>TOT</sub>	Total Channel Capacitance	At 2.5VDC, 1MHz, 30mVAC	187	234	281	pF
C <sub>1</sub>	C1 Capacitance	At 2.5VDC, 1MHz, 30mVAC	93	117	140	pF
V <sub>DIODE</sub>	Diode Standoff Voltage	I <sub>DIODE</sub> = 10 $\mu$ A		6.0		V
I <sub>LEAK</sub>	Diode Leakage Current	V <sub>IN</sub> = 3.3V (reverse bias voltage)		0.1	2	$\mu$ A
V <sub>SIG</sub>	Signal Clamp Voltage Positive Clamp Negative Clamp	I <sub>LOAD</sub> = 10mA I <sub>LOAD</sub> = -10mA	6.4 -9.8	7.6 -7.6	9.8 -6.4	V V
V <sub>ESD</sub>	In-system ESD Withstand Voltage a) Human Body Model, MIL-STD-883, Method 3015 b) Contact Discharge per IEC 61000-4-2 Level 4	Note 2	$\pm$ 30 $\pm$ 30			kV kV
R <sub>DYN</sub>	Dynamic Resistance Positive Negative			0.95 0.90		$\Omega$ $\Omega$
f <sub>c</sub>	Cut-off frequency Z <sub>SOURCE</sub> = 50 $\Omega$ , Z <sub>LOAD</sub> = 50 $\Omega$	R = 2 $\Omega$ , C = 117pF		21		MHz

Note 1: T<sub>A</sub>=25°C unless otherwise specified.

Note 2: ESD applied to input and output pins with respect to GND, one at a time.

Performance Information

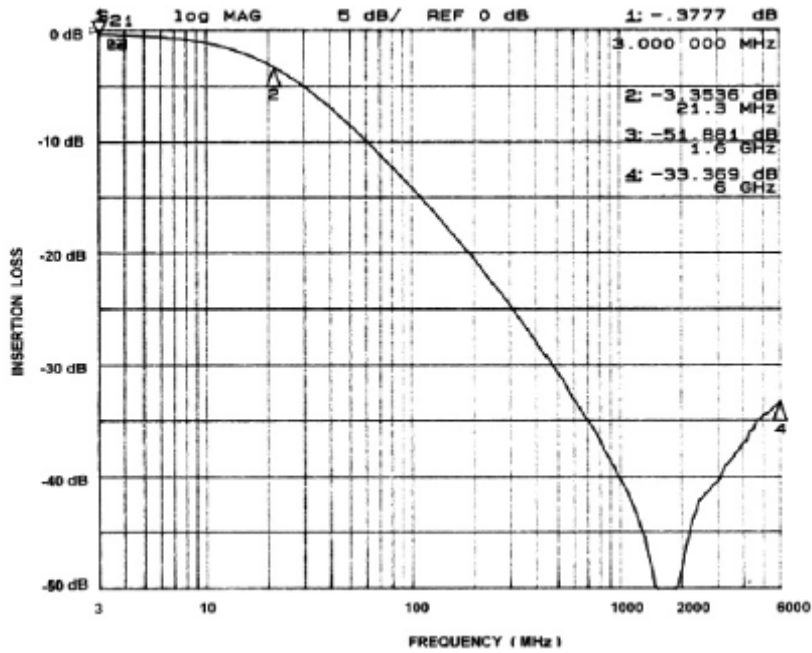

Figure 1. Typical EMI Filter Performance (0VDC, 50 Ohm Environment)

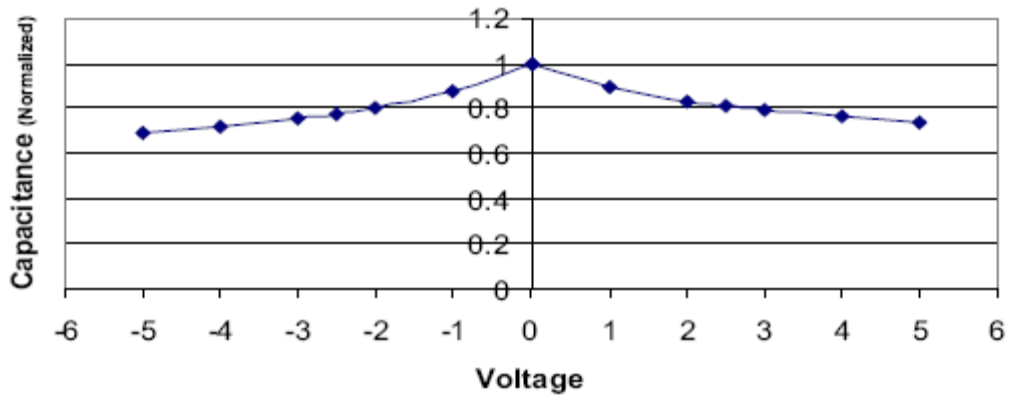

Figure 2. Typical Diode Capacitance VS. Input Voltage (normalized to 2.5VDC)

## Application Information

PARAMETER	VALUE
Pad Size on PCB	0.240mm
Pad Shape	Round
Pad Definition	Non-Solder Mask defined pads
Solder Mask Opening	0.290mm Round
Solder Stencil Thickness	0.125mm - 0.150mm
Solder Stencil Aperture Opening (laser cut, 5% tapered walls)	0.300mm Round
Solder Flux Ratio	50/50 by volume
Solder Paste Type	No Clean
Pad Protective Finish	OSP (Entek Cu Plus 106A)
Tolerance — Edge To Corner Ball	$\pm 50\mu\text{m}$
Solder Ball Side Coplanarity	$\pm 20\mu\text{m}$
Maximum Dwell Time Above Liquidous	60 seconds
Maximum Soldering Temperature for Lead-free Devices using a Lead-free Solder Paste	260°C

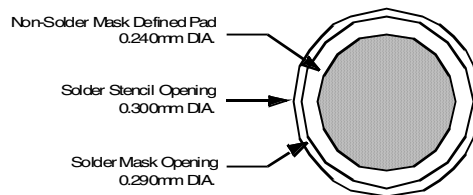

Figure 5. Recommended Non-Solder Mask Defined Pad Illustration

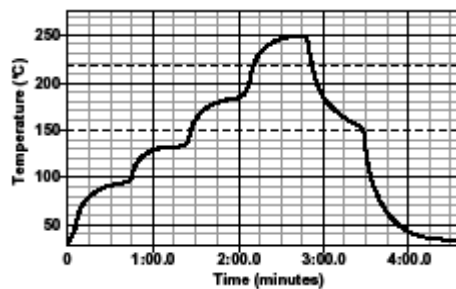

Figure 6. Lead-free (SnAgCu) Solder Ball Reflow Profile

# CM1416

## Mechanical Details

### CSP Mechanical Specifications

The CM1416 is supplied in a custom Chip Scale Package (CSP). Dimensions are presented below.

PACKAGE DIMENSIONS						
Package	Custom CSP					
Bumps	5					
Dim	Millimeters			Inches		
	Min	Nom	Max	Min	Nom	Max
A1	0.955	1.000	1.045	0.0376	0.0394	0.0411
A2	1.325	1.370	1.415	0.0522	0.0539	0.0557
B1	0.495	0.500	0.505	0.0195	0.0197	0.0199
B2	0.245	0.250	0.255	0.0096	0.0098	0.0100
B3	0.430	0.435	0.440	0.0169	0.0171	0.0173
B4	0.430	0.435	0.440	0.0169	0.0171	0.0173
C1	0.200	0.250	0.300	0.0079	0.0098	0.0118
C2	0.200	0.250	0.300	0.0079	0.0098	0.0118
D1	0.575	0.644	0.714	0.0226	0.0254	0.0281
D2	0.368	0.419	0.470	0.0145	0.0165	0.0185
# per tape and reel	3500 pieces					
Controlling dimension: millimeters						

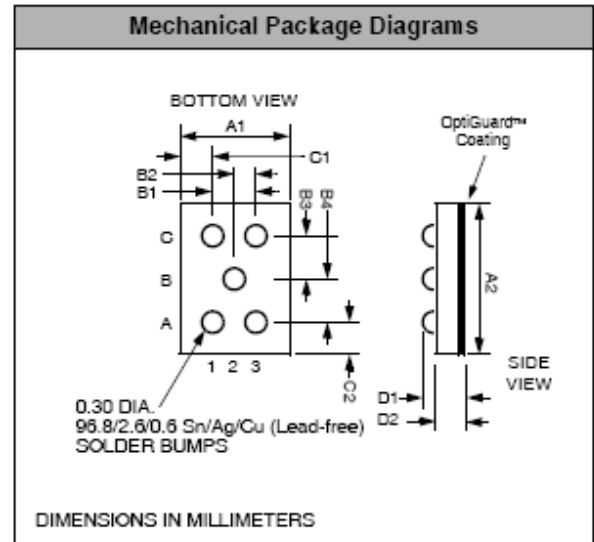

**Package Dimensions for  
CM1416 Chip Scale Package**

**CSP Tape and Reel Specifications**

PART NUMBER	CHIP SIZE (mm)	POCKET SIZE (mm) $B_0 \times A_0 \times K_0$	TAPE WIDTH $W$	REEL DIAMETER	QTY PER REEL	$P_0$	$P_1$
CM1416	1.33 x 0.96 x 0.644	1.42 x 1.07 x 0.74	8mm	178mm (7")	3500	4mm	4mm

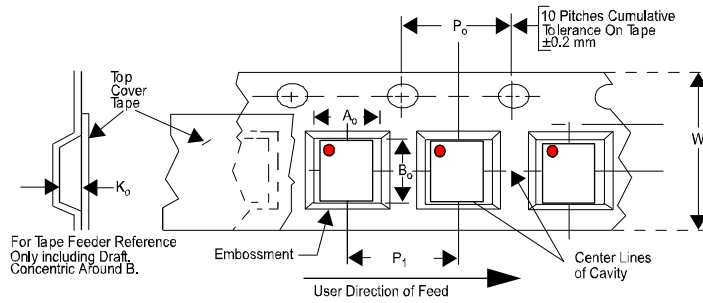

**Figure 5. Tape and Reel Mechanical Data**



ON Semiconductor and  are registered trademarks of Semiconductor Components Industries, LLC (SCILLC). SCILLC reserves the right to make changes without further notice to any products herein. SCILLC makes no warranty, representation or guarantee regarding the suitability of its products for any particular purpose, nor does SCILLC assume any liability arising out of the application or use of any product or circuit, and specifically disclaims any and all liability, including without limitation special, consequential or incidental damages. "Typical" parameters which may be provided in SCILLC data sheets and/or specifications can and do vary in different applications and actual performance may vary over time. All operating parameters, including "Typicals" must be validated for each customer application by customer's technical experts. SCILLC does not convey any license under its patent rights nor the rights of others. SCILLC products are not designed, intended, or authorized for use as components in systems intended for surgical implant into the body, or other applications intended to support or sustain life, or for any other application in which the failure of the SCILLC product could create a situation where personal injury or death may occur. Should Buyer purchase or use SCILLC products for any such unintended or unauthorized application, Buyer shall indemnify and hold SCILLC and its officers, employees, subsidiaries, affiliates, and distributors harmless against all claims, costs, damages, and expenses, and reasonable attorney fees arising out of, directly or indirectly, any claim of personal injury or death associated with such unintended or unauthorized use, even if such claim alleges that SCILLC was negligent regarding the design or manufacture of the part. SCILLC is an Equal Opportunity/Affirmative Action Employer. This literature is subject to all applicable copyright laws and is not for resale in any manner.

## PUBLICATION ORDERING INFORMATION

### LITERATURE FULFILLMENT:

Literature Distribution Center for ON Semiconductor  
P.O. Box 5163, Denver, Colorado 80217 USA  
**Phone:** 303-675-2175 or 800-344-3860 Toll Free USA/Canada  
**Fax:** 303-675-2176 or 800-344-3867 Toll Free USA/Canada  
**Email:** [orderlit@onsemi.com](mailto:orderlit@onsemi.com)

**N. American Technical Support:** 800-282-9855  
Toll Free USA/Canada  
**Europe, Middle East and Africa Technical Support:**  
Phone: 421 33 790 2910  
**Japan Customer Focus Center**  
Phone: 81-3-5773-3850

ON Semiconductor Website: [www.onsemi.com](http://www.onsemi.com)

Order Literature: <http://www.onsemi.com/orderlit>

For additional information, please contact your local Sales Representative