

EMI Filters

Series: **EXCEMT**

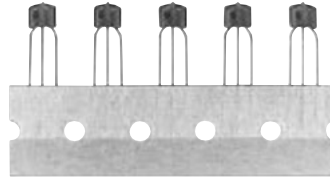

■ Features

- Panasonic EMI filters are small in size and taped type is available for automatic insertion machines.
- Filters are connected as a T network and have excellent noise filtering characteristics for high frequency.
- Preformed leads provide better solderability for through-hole P.W.B.
- Approved under the ISO 9001 system.

■ Recommended Applications

- Digital equipment such as Personal computers, Word processors, Printers, HDD, PPC, and Communication equipment
- Digital audio and Video equipment
- Power supply equipment such as AC adapter and Switching power supply
- Electronic automotive equipment such as Engine controls, Panels and Audio systems
- Electric musical instruments and other digital devices

■ Explanation of Part Numbers

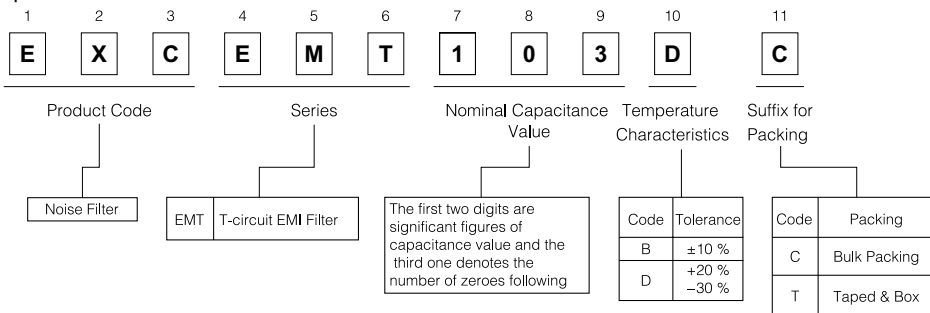

Construction

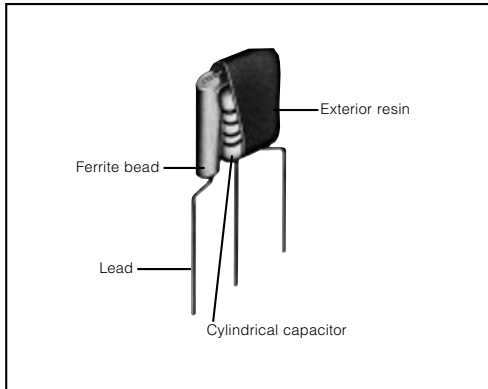

Schematic

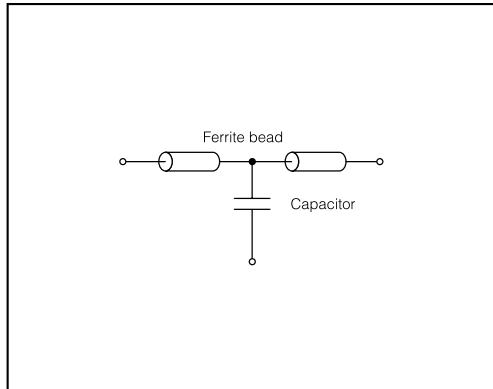

Ratings

Category Temperature Range (Operating Temp. Range): -25 °C to +85 °C

Part Number	Rated Voltage (V DC)	Capacitance ⁽¹⁾ (pF)	Tolerance (%)	Temperature Characteristics ⁽²⁾	Rated Current (A DC)	25 dB Attenuation ⁽³⁾ Frequency (MHz)	15 dB Attenuation ⁽³⁾ Frequency (MHz)
EXCEMT220B□	50	22	±20	YB	5	800 to 1000	600 to 1000
EXCEMT470B□	50	47	±20	YB	5	450 to 700	400 to 1000
EXCEMT101B□	50	100	±20	YB	5	350 to 550	250 to 900
EXCEMT221B□	50	220	±20	YB	5	250 to 400	150 to 500
EXCEMT271B□	50	270	±20	YB	5	250 to 400	150 to 500
EXCEMT471B□	50	470	±20	YB	5	150 to 350	70 to 500
EXCEMT102B□	50	1000	±20	YB	5	100 to 250	50 to 400
EXCEMT222D□	16	2200	±20	YD	5	50 to 200	30 to 400
EXCEMT332D□	16	3300	±20	YD	5	40 to 160	25 to 400
EXCEMT103D□	16	10000	±30	YD	5	25 to 120	15 to 400

↑ Lead Cut Type: C, Taped Type: T

(1) Measurement Temperature: +20 °C, Measurement Frequency: 1 kHz

(2) Temperature Characteristics YB: Maximum capacitance change is ±10 % over the temperature range of -25 °C to +85 °C in reference to +20 °C
 YD: Maximum capacitance change is +20, -30 % over the temperature range of -25 °C to +85 °C in reference to +20 °C

(3) Measurement Temperature: +20 °C

Note: Please inquire about the particular capacitance value, on a range of 22 to 10000 pF.

■ Dimensions in mm (not to scale)

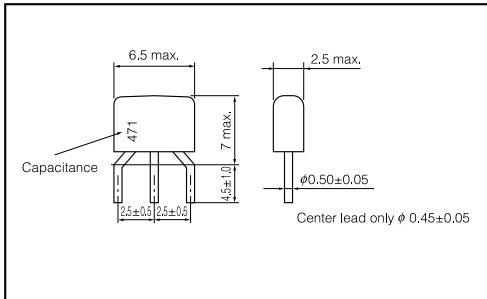

■ Standard Lead Taping in mm (not to scale)

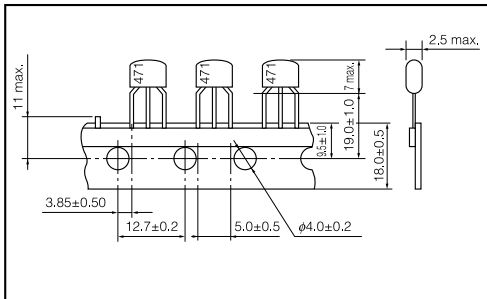

■ Typical Attenuation Characteristics

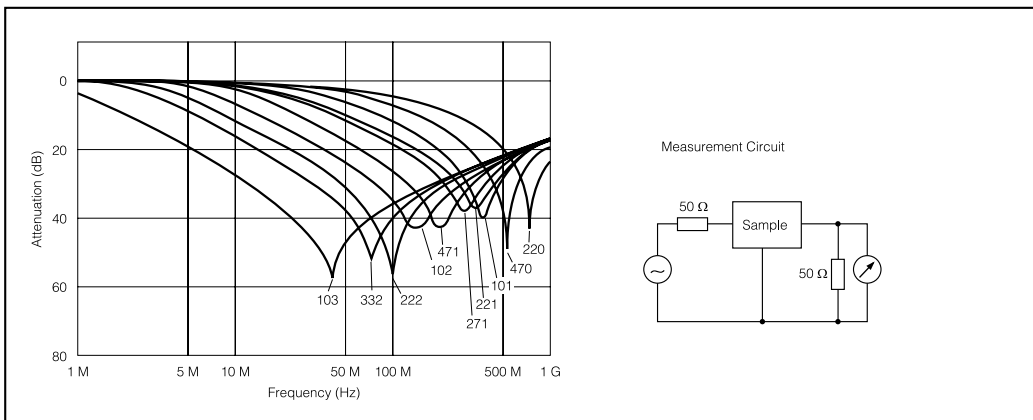

■ Packing Methods

Part Number	Standard Quantity	Style	Weight (mg/pcs.)
EXCEMT□□□□C	200 pcs./Bag	Bulk	216
EXCEMT□□□□T	2000 pcs./Box	Flat box	291

Safety Precautions

- The filter may fail in a short-circuit mode (or open-circuit mode) when subjected to severe conditions of electrical and/or environmental stresses beyond their specified rating, resulting in burnout or glowing in the worst case. Study operation of the circuit.
- Soldering Flux: Use rosin type or nonhalogenous type flux.
- Cleaning Solvent: Use alcohol type. Inquire for other type of cleaning solvent.
- Avoid application of static electricity to the filter.
- The filter is deteriorated in the circuit where surge or other abnormal voltage is apt to occur. Study operation of the circuit.
- Excessive mechanical stress may damage the components. Take care in handling.
- Store under temperature -5°C to $+40^{\circ}\text{C}$ and relative humidity 40 % to 60 %. Avoid rapid changes of temperature and humidity.
- Use the components within one year after our delivery.
- This catalog shows the quality and performance of unit component. For quality assurance, please confirm your specific requirements with us. Before design-in, be sure to evaluate and verify the product by mounting it in your product.