

IP4035CX24

10-channel integrated filter network with ESD input protection to IEC 61000-4-2 level 4

Rev. 01 — 12 February 2010

Product data sheet

1. Product profile

1.1 General description

The IP4035CX24 is a 10-channel RC low-pass filter array which is designed to provide filtering of undesired RF signals. In addition, the IP4035CX24 incorporates diodes to provide protection to downstream components from ElectroStatic Discharge (ESD) voltages as high as ± 30 kV contact according the IEC 61000-4-2 standard, far exceeding level 4.

The IP4035CX24 is fabricated using monolithic silicon technology and integrates 10 resistors and 20 diodes in a single Wafer-Level Chip-Scale Package (WLCSP). These features make the IP4035CX24 ideal for use in applications requiring the utmost in miniaturization such as mobile phone handsets, cordless telephones and personal digital devices.

1.2 Features and benefits

- Pb-free, RoHS compliant and free of halogen and antimony (Dark Green compliant)
- 10-channel integrated π -type RC filter network
- 1 k Ω series resistance; 100 pF (typical) channel capacitance
- Integrated ESD protection withstanding ± 30 kV contact discharge, far exceeding IEC 61000-4-2 level 4
- WLCSP with 0.5 mm pitch

1.3 Applications

Reduce ElectroMagnetic Interference (EMI) and Radio Frequency Interference (RFI) and provide downstream ESD protection for:

- Cellular and Personal Communication System (PCS) mobile handsets
- Cordless telephones
- Other appliances with low frequency signals (e.g. keypads)



2. Pinning information

2.1 Pinning

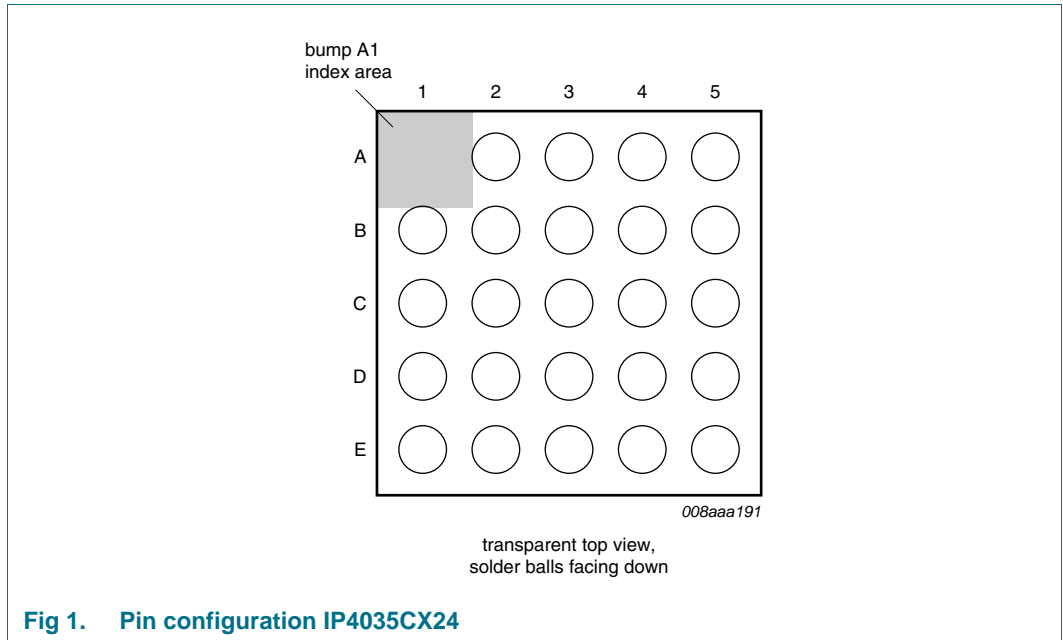

2.2 Pin description

Table 1. Pinning

Pin	Description
B1 and D1	filter channel 1
A2 and D2	filter channel 2
B2 and D3	filter channel 3
A5 and D4	filter channel 4
B5 and D5	filter channel 5
C1 and E1	filter channel 6
C2 and E2	filter channel 7
C3 and E3	filter channel 8
C4 and E4	filter channel 9
C5 and E5	filter channel 10
A3, A4, B3, B4	ground
A1	no ball

3. Ordering information

Table 2. Ordering information

Type number	Package		Version
	Name	Description	
IP4035CX24	WLCSP24	wafer level chip-size package; 24 bumps; 2.45 × 2.41 × 0.65 mm	IP4035CX24

4. Functional diagram

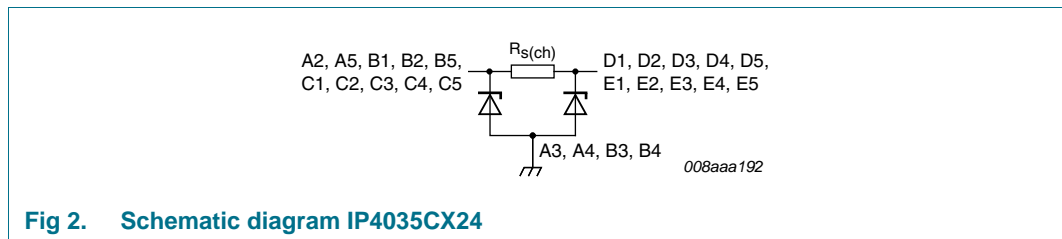

Fig 2. Schematic diagram IP4035CX24

5. Limiting values

Table 3. Limiting values

In accordance with the Absolute Maximum Rating System (IEC 60134).

Symbol	Parameter	Conditions	Min	Max	Unit
V_I	input voltage		-0.5	+5.5	V
V_{ESD}	electrostatic discharge voltage	all pins to ground			
		contact discharge	[1] -30	+30	kV
		air discharge	[1] -30	+30	kV
		IEC 61000-4-2 level 4; all pins to ground			
		contact discharge	-8	+8	kV
		air discharge	-15	+15	kV
I_{ch}	channel current (DC)	current flow between external and internal pins	-	7	mA
P_{ch}	channel power dissipation	continuous power	-	42	mW
P_{tot}	total power dissipation	continuous power	-	420	mW
T_{stg}	storage temperature		-55	+150	°C
$T_{reflow(peak)}$	peak reflow temperature	10 s maximum	-	260	°C
T_{amb}	ambient temperature		-45	+85	°C

[1] Device is qualified with 1000 pulses of ±15 kV contact discharges each, according to the IEC 61000-4-2 model and far exceeds the specified level 4 (8 kV contact discharge).

6. Characteristics

Table 4. Channel characteristics

$T_{amb} = 25\text{ }^{\circ}\text{C}$; unless otherwise specified.

Symbol	Parameter	Conditions	Min	Typ	Max	Unit
$R_{s(ch)}$	channel series resistance		900	1000	1100	Ω
C_{ch}	channel capacitance	$V_{bias(DC)} = 0\text{ V}$; $f = 1\text{ MHz}$	40	50	60	pF
V_{BR}	breakdown voltage	$I_{test} = 1\text{ mA}$	6	-	15	V
I_{LR}	reverse leakage current	per channel; $V_I = 3.0\text{ V}$	-	-	20	nA

Table 5. Frequency characteristics

$T_{amb} = 25\text{ }^{\circ}\text{C}$; unless otherwise specified.

Symbol	Parameter	Conditions	Min	Typ	Max	Unit
α_{il}	insertion loss	$800\text{ MHz} < f < 3\text{ GHz}$; $R_{gen} = 50\ \Omega$; $R_L = 50\ \Omega$	-	25	-	dB
α_{ct}	crosstalk attenuation	$800\text{ MHz} < f < 3\text{ GHz}$; $R_{gen} = 50\ \Omega$; $R_L = 50\ \Omega$	-	-25	-	dB

7. Application information

7.1 Insertion loss

The insertion loss measurement configuration of a typical 50 Ω NetWork Analyzer (NWA) system for evaluation of the IP4035CX24 is shown in [Figure 3](#).

The insertion loss of all channels for frequencies up to 6 GHz is displayed in [Figure 4](#).

The insertion loss is measured with a test PCB utilizing laser drilled micro-via holes that connect the PCB ground plane to the IP4035CX24 ground pins.

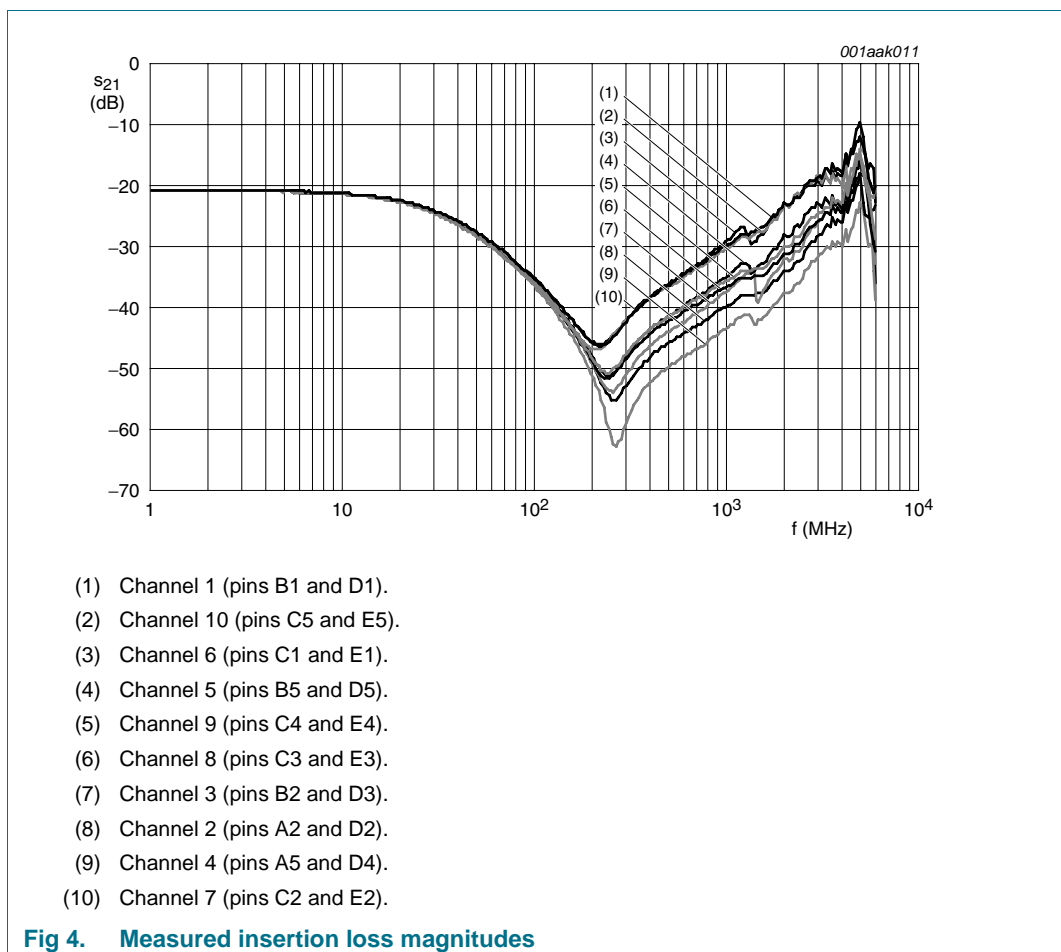
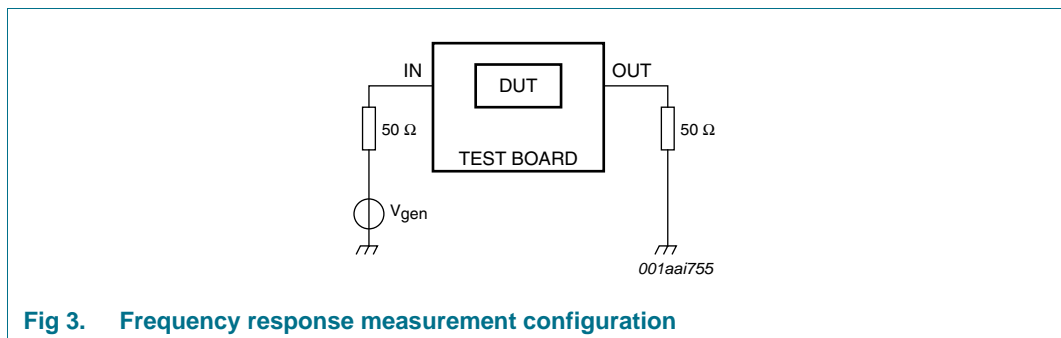

7.2 Crosstalk

The crosstalk measurement configuration of a typical 50 Ω NWA system for evaluation of the IP4035CX24 is shown in [Figure 5](#).

The measured crosstalk within the IP4035CX24 in a 50 Ω NWA system from one channel to another is shown in [Figure 6](#) for two different pairs of channels representing both the worst and the best case conditions in terms of physical distance. In both cases the signal input pin is C1. While pin E2 is very close to the input, pin E5 is relatively far away. In all cases, unused connections are terminated with 50 Ω to ground.

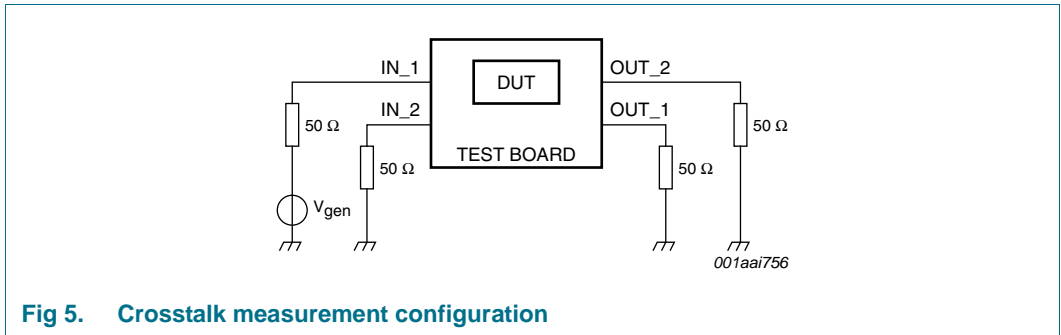
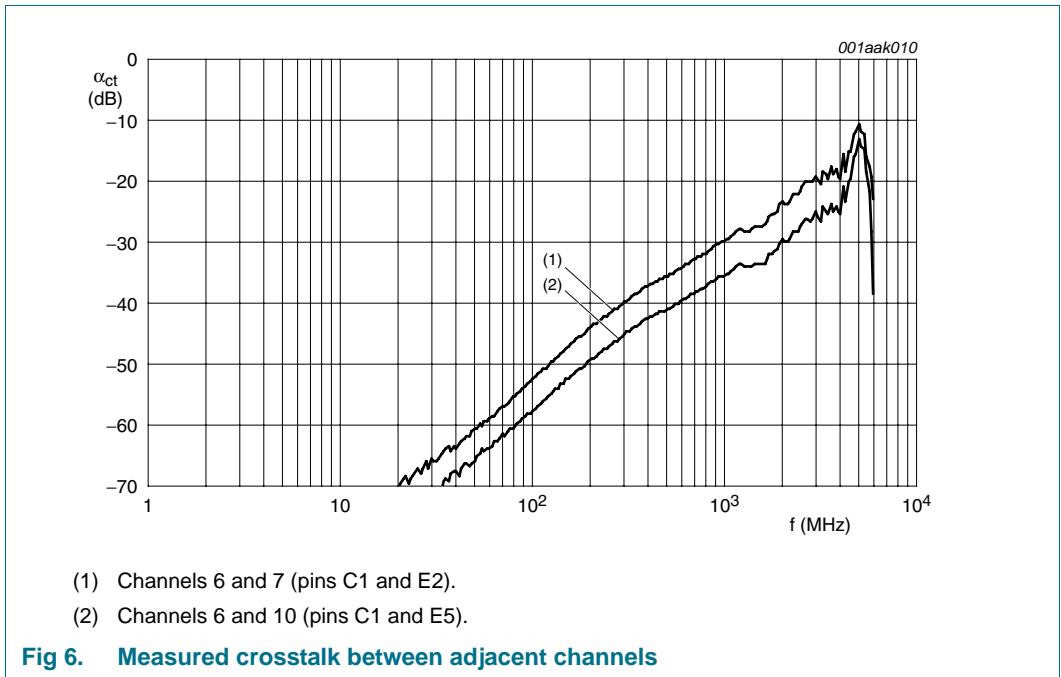

Fig 5. Crosstalk measurement configuration



- (1) Channels 6 and 7 (pins C1 and E2).
- (2) Channels 6 and 10 (pins C1 and E5).

Fig 6. Measured crosstalk between adjacent channels

8. Package outline

WLCSP24: wafer level chip-size package; 24 bumps (5 x 5 - A1)

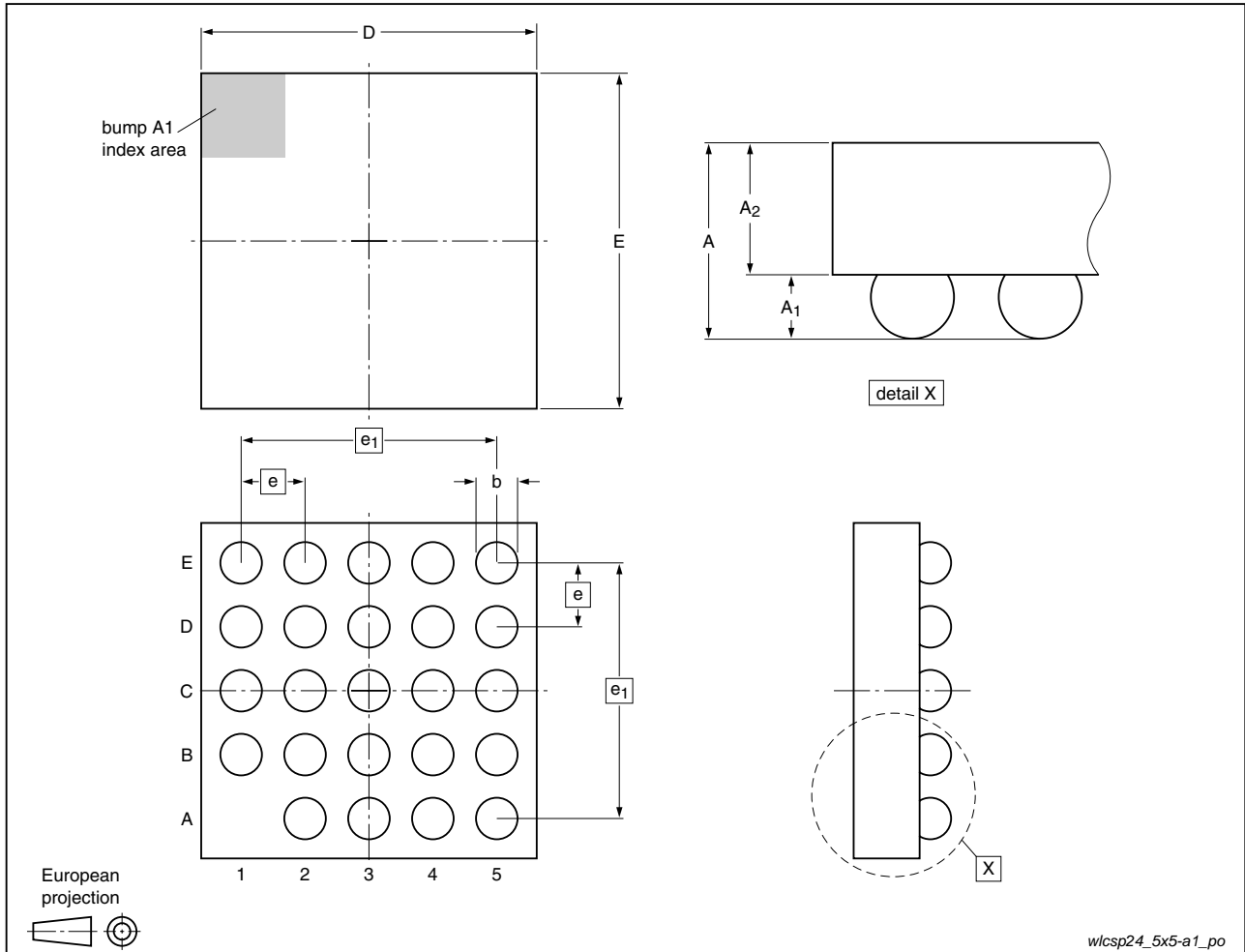

Fig 7. Package outline IP4035CX24 (WLCSP24)

Table 6. Dimensions for Figure 7

Symbol	Min	Typ	Max	Unit
A	0.60	0.65	0.70	mm
A ₁	0.22	0.24	0.26	mm
A ₂	0.38	0.41	0.44	mm
b	0.27	0.32	0.37	mm
D	2.40	2.45	2.50	mm
E	2.36	2.41	2.46	mm
e	-	0.5	-	mm
e ₁	-	2.0	-	mm

9. Design and assembly recommendations

9.1 PCB design guidelines

For optimum performance it is recommended to use a Non-Solder Mask PCB Design (NSMD), also known as a copper-defined design, incorporating laser-drilled micro-vias connecting the ground pads to a buried ground-plane layer. This results in the lowest possible ground inductance and provides the best high frequency and ESD performance. For this case, refer to [Table 7](#) for the recommended PCB design parameters.

Table 7. Recommended PCB design parameters

Parameter	Value or specification
PCB pad diameter	200 μm
Micro-via diameter	100 μm (0.004 inch)
Solder mask aperture diameter	370 μm
Copper thickness	20 μm to 40 μm
Copper finish	AuNi
PCB material	FR4

9.2 PCB assembly guidelines for Pb-free soldering

Table 8. Assembly recommendations

Parameter	Value or specification
Solder screen aperture diameter	330 μm
Solder screen thickness	100 μm (0.004 inch)
Solder paste: Pb-free	SnAg (3 % to 4 %) Cu (0.5 % to 0.9 %)
Solder / flux ratio	50 / 50
Solder reflow profile	see Figure 8

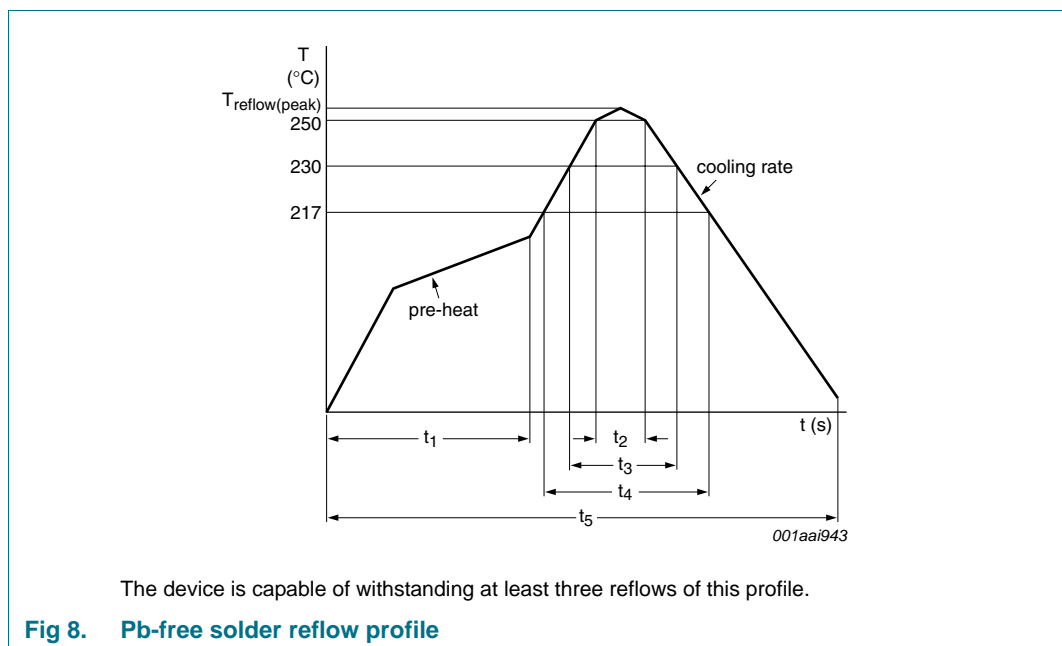

Table 9. Characteristics

Symbol	Parameter	Conditions	Min	Typ	Max	Unit
$T_{\text{reflow(peak)}}$	peak reflow temperature		230	-	260	°C
t_1	time 1	soak time	60	-	180	s
t_2	time 2	time during $T \geq 250$ °C	-	-	30	s
t_3	time 3	time during $T \geq 230$ °C	10	-	50	s
t_4	time 4	time during $T > 217$ °C	30	-	150	s
t_5	time 5		-	-	540	s
dT/dt	rate of change of temperature	cooling rate	-	-	-6	°C/s
		pre-heat	2.5	-	4.0	°C/s

10. Abbreviations

Table 10. Abbreviations

Acronym	Description
DUT	Device Under Test
EMI	ElectroMagnetic Interference
ESD	ElectroStatic Discharge
FR4	Flame Retard 4
NSMD	Non-Solder Mask PCB Design
PCB	Printed-Circuit Board
PCS	Personal Communication System
RFI	Radio Frequency Interference
RoHS	Restriction of Hazardous Substances
WLCSP	Wafer-Level Chip-Scale Package

11. Revision history

Table 11. Revision history

Document ID	Release date	Data sheet status	Change notice	Supersedes
IP4035CX24_1	20100212	Product data sheet	-	-

12. Legal information

12.1 Data sheet status

Document status ^{[1][2]}	Product status ^[3]	Definition
Objective [short] data sheet	Development	This document contains data from the objective specification for product development.
Preliminary [short] data sheet	Qualification	This document contains data from the preliminary specification.
Product [short] data sheet	Production	This document contains the product specification.

[1] Please consult the most recently issued document before initiating or completing a design.

[2] The term 'short data sheet' is explained in section "Definitions".

[3] The product status of device(s) described in this document may have changed since this document was published and may differ in case of multiple devices. The latest product status information is available on the Internet at URL <http://www.nxp.com>.

12.2 Definitions

Draft — The document is a draft version only. The content is still under internal review and subject to formal approval, which may result in modifications or additions. NXP Semiconductors does not give any representations or warranties as to the accuracy or completeness of information included herein and shall have no liability for the consequences of use of such information.

Short data sheet — A short data sheet is an extract from a full data sheet with the same product type number(s) and title. A short data sheet is intended for quick reference only and should not be relied upon to contain detailed and full information. For detailed and full information see the relevant full data sheet, which is available on request via the local NXP Semiconductors sales office. In case of any inconsistency or conflict with the short data sheet, the full data sheet shall prevail.

Product specification — The information and data provided in a Product data sheet shall define the specification of the product as agreed between NXP Semiconductors and its customer, unless NXP Semiconductors and customer have explicitly agreed otherwise in writing. In no event however, shall an agreement be valid in which the NXP Semiconductors product is deemed to offer functions and qualities beyond those described in the Product data sheet.

12.3 Disclaimers

Limited warranty and liability — Information in this document is believed to be accurate and reliable. However, NXP Semiconductors does not give any representations or warranties, expressed or implied, as to the accuracy or completeness of such information and shall have no liability for the consequences of use of such information.

In no event shall NXP Semiconductors be liable for any indirect, incidental, punitive, special or consequential damages (including - without limitation - lost profits, lost savings, business interruption, costs related to the removal or replacement of any products or rework charges) whether or not such damages are based on tort (including negligence), warranty, breach of contract or any other legal theory.

Notwithstanding any damages that customer might incur for any reason whatsoever, NXP Semiconductors' aggregate and cumulative liability towards customer for the products described herein shall be limited in accordance with the *Terms and conditions of commercial sale* of NXP Semiconductors.

Right to make changes — NXP Semiconductors reserves the right to make changes to information published in this document, including without limitation specifications and product descriptions, at any time and without notice. This document supersedes and replaces all information supplied prior to the publication hereof.

Suitability for use — NXP Semiconductors products are not designed, authorized or warranted to be suitable for use in medical, military, aircraft, space or life support equipment, nor in applications where failure or

malfunction of an NXP Semiconductors product can reasonably be expected to result in personal injury, death or severe property or environmental damage. NXP Semiconductors accepts no liability for inclusion and/or use of NXP Semiconductors products in such equipment or applications and therefore such inclusion and/or use is at the customer's own risk.

Applications — Applications that are described herein for any of these products are for illustrative purposes only. NXP Semiconductors makes no representation or warranty that such applications will be suitable for the specified use without further testing or modification.

NXP Semiconductors does not accept any liability related to any default, damage, costs or problem which is based on a weakness or default in the customer application/use or the application/use of customer's third party customer(s) (hereinafter both referred to as "Application"). It is customer's sole responsibility to check whether the NXP Semiconductors product is suitable and fit for the Application planned. Customer has to do all necessary testing for the Application in order to avoid a default of the Application and the product. NXP Semiconductors does not accept any liability in this respect.

Limiting values — Stress above one or more limiting values (as defined in the Absolute Maximum Ratings System of IEC 60134) will cause permanent damage to the device. Limiting values are stress ratings only and (proper) operation of the device at these or any other conditions above those given in the Recommended operating conditions section (if present) or the Characteristics sections of this document is not warranted. Constant or repeated exposure to limiting values will permanently and irreversibly affect the quality and reliability of the device.

Terms and conditions of commercial sale — NXP Semiconductors products are sold subject to the general terms and conditions of commercial sale, as published at <http://www.nxp.com/profile/terms>, unless otherwise agreed in a valid written individual agreement. In case an individual agreement is concluded only the terms and conditions of the respective agreement shall apply. NXP Semiconductors hereby expressly objects to applying the customer's general terms and conditions with regard to the purchase of NXP Semiconductors products by customer.

No offer to sell or license — Nothing in this document may be interpreted or construed as an offer to sell products that is open for acceptance or the grant, conveyance or implication of any license under any copyrights, patents or other industrial or intellectual property rights.

Export control — This document as well as the item(s) described herein may be subject to export control regulations. Export might require a prior authorization from national authorities.

Non-automotive qualified products — Unless the data sheet of an NXP Semiconductors product expressly states that the product is automotive qualified, the product is not suitable for automotive use. It is neither qualified nor tested in accordance with automotive testing or application requirements. NXP Semiconductors accepts no liability for inclusion and/or use of non-automotive qualified products in automotive equipment or applications.

In the event that customer uses the product for design-in and use in automotive applications to automotive specifications and standards, customer (a) shall use the product without NXP Semiconductors' warranty of the

product for such automotive applications, use and specifications, and (b) whenever customer uses the product for automotive applications beyond NXP Semiconductors' specifications such use shall be solely at customer's own risk, and (c) customer fully indemnifies NXP Semiconductors for any liability, damages or failed product claims resulting from customer design and use of the product for automotive applications beyond NXP Semiconductors' standard warranty and NXP Semiconductors' product specifications.

12.4 Trademarks

Notice: All referenced brands, product names, service names and trademarks are the property of their respective owners.

13. Contact information

For more information, please visit: <http://www.nxp.com>

For sales office addresses, please send an email to: salesaddresses@nxp.com

14. Contents

1	Product profile	1
1.1	General description	1
1.2	Features and benefits	1
1.3	Applications	1
2	Pinning information	2
2.1	Pinning	2
2.2	Pin description	2
3	Ordering information	3
4	Functional diagram	3
5	Limiting values	3
6	Characteristics	4
7	Application information	5
7.1	Insertion loss	5
7.2	Crosstalk	6
8	Package outline	7
9	Design and assembly recommendations	8
9.1	PCB design guidelines	8
9.2	PCB assembly guidelines for Pb-free soldering	8
10	Abbreviations	9
11	Revision history	9
12	Legal information	10
12.1	Data sheet status	10
12.2	Definitions	10
12.3	Disclaimers	10
12.4	Trademarks	11
13	Contact information	11
14	Contents	12

Please be aware that important notices concerning this document and the product(s) described herein, have been included in section 'Legal information'.

© NXP B.V. 2010.

All rights reserved.

For more information, please visit: <http://www.nxp.com>

For sales office addresses, please send an email to: salesaddresses@nxp.com

Date of release: 12 February 2010

Document identifier: IP4035CX24_1