

# EMI9404

## PRAETORIAN® III 4-Channel EMI Array with ESD Protection

### Description

The EMI9404 is an inductor-based (L-C) EMI filter array with ESD protection, which integrates four filters in a UDFN package with 0.40 mm pitch. Each EMI filter channel of the EMI9404 is implemented with the component value of 1.8 pF–35 nH–4.7 pF–35 nH– 6 pF. The cut-off frequency at –3 dB attenuation is 300 MHz and can be used in applications where the data rates are as high as 160 Mbps, while providing greater than –35 dB attenuation over the 800 MHz to 2.7 GHz frequency range. The parts include ESD diodes on every I/O pin and provide a high level of protection against electrostatic discharge (ESD). The ESD protection diodes connected to the external filter ports are designed and characterized to safely dissipate ESD strikes of ±14 kV, which is beyond the maximum requirement of the IEC61000–4–2 international standard.

This device is particularly well suited for wireless handsets, mobile LCD modules and PDAs because of its small package format and easy-to-use pin assignments. In particular, the EMI9404 is ideal for EMI filtering and protecting data and control lines for the LCD display and camera interface in mobile handsets.

The EMI9404 is housed in space saving, low profile, 0.40 mm pitch UDFN packages in a RoHS compliant, Pb-Free format.

### Features

- Four Channels of EMI Filtering with Integrated ESD Protection
- ±14 kV ESD Protection (IEC 61000–4–2, contact discharge) at External Pin
- Greater than –40 dB Attenuation (typical) at 1 GHz
- UDFN Pb-Free Package with 0.40 mm Lead Pitch:  
4-ch. = 8-lead UDFN
- UDFN Package Size: 8-lead: 1.70 mm x 1.35 mm
- Increased Robustness Against Vertical Impacts During Manufacturing Process
- These Devices are Pb-Free and are RoHS Compliant

### Applications

- LCD and Camera Data Lines in Mobile Handsets
- I/O Port Protection for Mobile Handsets, Notebook Computers, PDAs etc.
- EMI Filtering for Data Ports in Cell Phones, PDAs or Notebook Computers
- Wireless Handsets
- Handheld PCs/PDAs
- LCD and Camera Modules



ON Semiconductor®

<http://onsemi.com>

### MARKING DIAGRAMS



UDFN8  
CASE 517BC

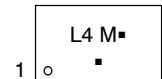

- L4 = Specific Device Code
- M = Date Code
- = Pb-Free Package

(\*Note: Microdot may be in either location)

### PINOUTS

Internal Pins  
(Lower ESD Event)

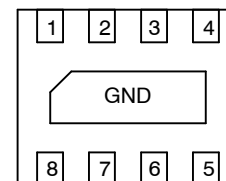

External Pins  
(Higher ESD Event)  
(Bottom View)

### ORDERING INFORMATION

See detailed ordering and shipping information in the package dimensions section on page 3 of this data sheet.

# EMI9404

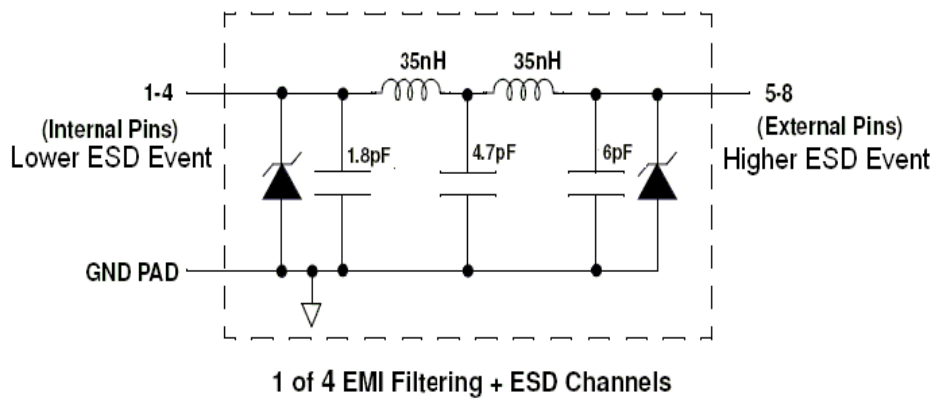

Figure 1. Electrical Schematic

Table 1. PIN DESCRIPTIONS

| Pin #   | Name    | Description                       |
|---------|---------|-----------------------------------|
| 1       | FILTER1 | Filter + ESD Channel 1 (Internal) |
| 2       | FILTER2 | Filter + ESD Channel 2 (Internal) |
| 3       | FILTER3 | Filter + ESD Channel 3 (Internal) |
| 4       | FILTER4 | Filter + ESD Channel 4 (Internal) |
| 5       | FILTER4 | Filter + ESD Channel 4 (External) |
| 6       | FILTER3 | Filter + ESD Channel 3 (External) |
| 7       | FILTER2 | Filter + ESD Channel 2 (External) |
| 8       | FILTER1 | Filter + ESD Channel 1 (External) |
| GND PAD | GND     | Device Ground                     |

## SPECIFICATIONS

### MAXIMUM RATINGS

| Parameter                 | Value       | Unit |
|---------------------------|-------------|------|
| Storage Temperature Range | -65 to +150 | °C   |
| Current per Inductor      | 15          | mA   |
| DC Package Power Rating   | 500         | mW   |

Stresses exceeding Maximum Ratings may damage the device. Maximum Ratings are stress ratings only. Functional operation above the Recommended Operating Conditions is not implied. Extended exposure to stresses above the Recommended Operating Conditions may affect device reliability.

### STANDARD OPERATING CONDITIONS

| Parameter                   | Rating     | Unit |
|-----------------------------|------------|------|
| Operating Temperature Range | -40 to +85 | °C   |

# EMI9404

## ELECTRICAL OPERATING CHARACTERISTICS (Note 1)

| Symbol          | Parameter  | Conditions   | Min                                     | Typ                        | Max         | Unit     |
|-----------------|--|--|---|----------------------------|-------------|----------|
| $L_{TOT}$       | Total Channel Inductance   |  |   | 70                         |             | nH       |
| $R_{TOT}$       | Total Channel DC Resistance  |  |   | 45                         |             | $\Omega$ |
| $C_{TOT\_0V}$   | Total Channel Capacitance, 0 V bias  | 0 V dc; 1 MHz, 30 mV <sub>rms</sub>                                      |   | 17.5                       | 24          | pF       |
| $C_{TOT\_2.5V}$ | Total Channel Capacitance, 2.5 V bias  | 2.5 V dc; 1 MHz, 30 mV <sub>rms</sub>                                    |   | 11.5                       |             | pF       |
| $V_{ST}$        | Stand-off Voltage  | $I = 10 \mu A$   | 5.5                                     |                            |             | V        |
| $I_{LEAK}$      | Diode Leakage Current  | $V_{IN} = +3.3 V$  |   | 0.1                        | 0.5         | $\mu A$  |
| $V_{SIG}$       | Signal Clamp Voltage Positive Clamp<br>Negative Clamp  | $I_{LOAD} = 10 mA$<br>$I_{LOAD} = -10 mA$                                | 5.6<br>-1.5                             | 6.8<br>-0.8                | 9.0<br>-0.4 | V        |
| $V_{ESD}$       | In-system ESD Withstand Voltage<br>a) Contact discharge per IEC 61000-4-2 standard, Level 4 ( <b>External Pins</b> )<br>b) Contact discharge per IEC 61000-4-2 standard, Level 1 ( <b>Internal Pins</b> )<br>c.) Air discharge per IEC61000-4-2 standard. Level 4 ( <b>External Pins</b> ) | Notes 2 and 3  | $\pm 14$<br><br>$\pm 2$<br><br>$\pm 16$ |                            |             | kV       |
| $V_C$           | Clamping Voltage<br>TLP (Note 4)<br>See Figures 4 through 7  | $I_{PP} = 8 A$<br>$I_{PP} = 16 A$<br>$I_{PP} = -8 A$<br>$I_{PP} = -16 A$ |   | 13.7<br>20<br>-4.4<br>-7.6 |             | V        |
| $f_c$           | Cut-off frequency $Z_{SOURCE} = 50 \Omega$ ,<br>$Z_{LOAD} = 50 \Omega$   |  |   | 345                        |             | MHz      |

- $T_A = 25^\circ C$  unless otherwise specified.
- ESD applied to input and output pins with respect to GND, one at a time.
- Unused pins are left open.
- ANSI/ESD STM5.5.1 – Electrostatic Discharge Sensitivity Testing using Transmission Line Pulse (TLP) Model.  
TLP conditions:  $Z_0 = 50 \Omega$ ,  $t_p = 100 ns$ ,  $t_r = 4 ns$ , averaging window;  $t_1 = 30 ns$  to  $t_2 = 60 ns$ .

## PERFORMANCE INFORMATION

### TYPICAL FILTER PERFORMANCE

( $T_A = 25^\circ C$ , DC Bias = 0 V, 50  $\Omega$  Environment)

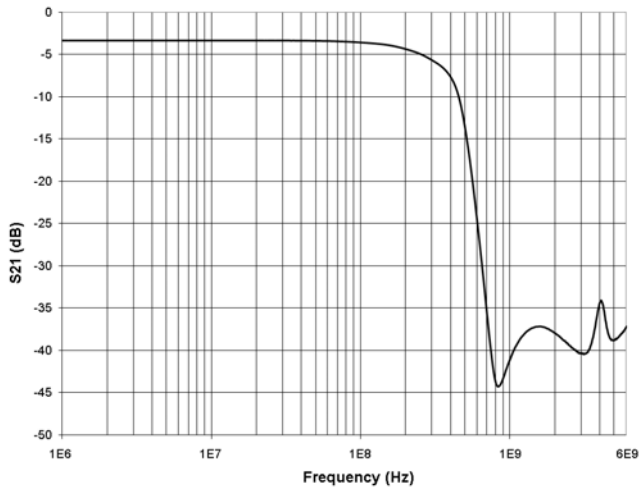

Figure 2. Typical Filter Insertion Loss

### TYPICAL DIODE CAPACITANCE VS. INPUT VOLTAGE

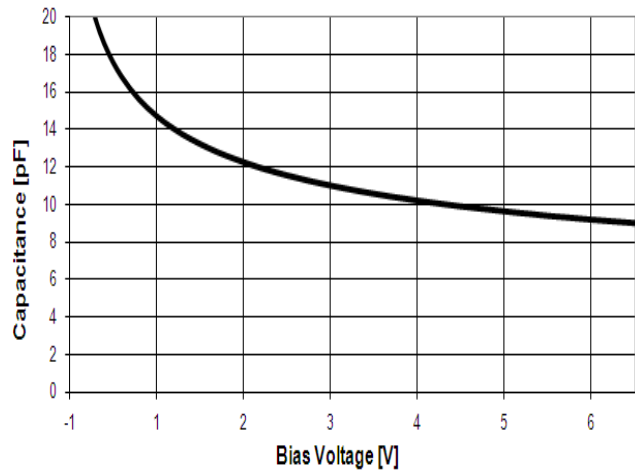

Figure 3. Filter Capacitance vs. Input Voltage (Normalized to Capacitance at 0 VDC and 25°C)

## ORDERING INFORMATION

| Device       | Pins | Marking | Package          | Shipping†          |
|--------------|------|---------|------------------|--------------------|
| EMI9404MUTAG | 8    | L4      | uDFN-8 (Pb-Free) | 3000 / Tape & Reel |

†For information on tape and reel specifications, including part orientation and tape sizes, please refer to our Tape and Reel Packaging Specifications Brochure, BRD8011/D.

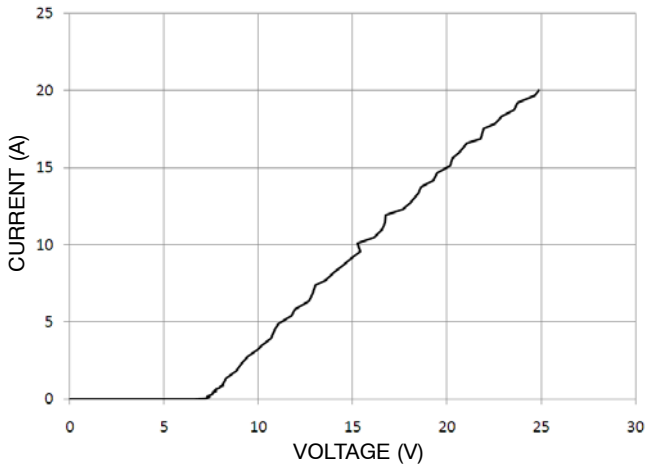

Figure 4. Positive TLP I-V Curve

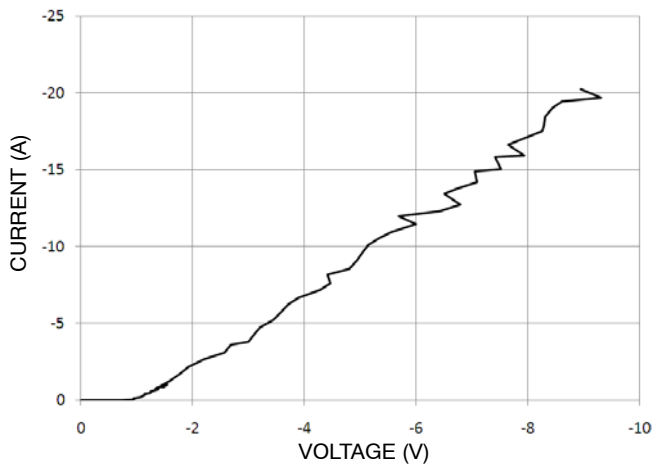

Figure 5. Negative TLP I-V Curve

**Transmission Line Pulse (TLP) Measurement**

Transmission Line Pulse (TLP) provides current versus voltage (I-V) curves in which each data point is obtained from a 100 ns long rectangular pulse from a charged transmission line. A simplified schematic of a typical TLP system is shown in Figure 6. TLP I-V curves of ESD protection devices accurately demonstrate the product’s ESD capability because the 10s of amps current levels and under 100 ns time scale match those of an ESD event. This is illustrated in Figure 7 where an 8 kV IEC 61000-4-2 current waveform into a short is compared with TLP current pulses at 8 A and 16 A, also into a short. A TLP I-V curve shows the voltage at which the device turns on, as well as how well the device clamps voltage over a range of current levels. Typical TLP I-V curves for the EMI9404 are shown in Figures 4 and 5 for positive and negative stress respectively. Application note AND9007/D gives more

detail on TLP datasheet parameters, while application note AND9006/D provides a more complete explanation of the use of TLP for understanding protection product characteristics.

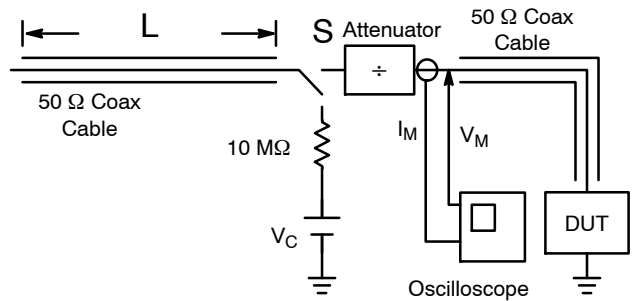

Figure 6. Simplified Schematic of a Typical TLP System

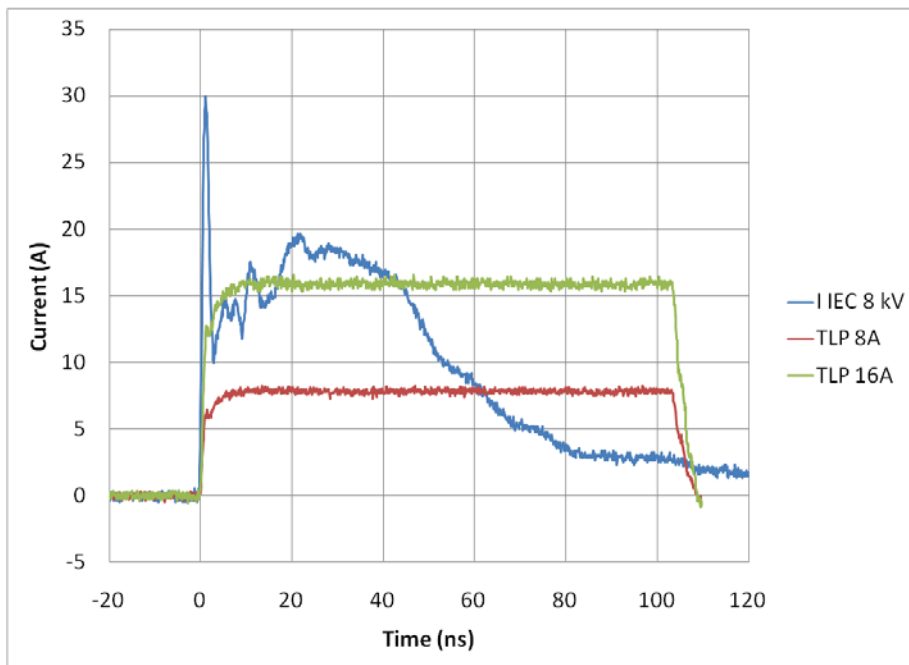

Figure 7. Comparison Between 8 kV IEC 61000-4-2 and 8 A and 16 A TLP Waveforms

# MECHANICAL CASE OUTLINE PACKAGE DIMENSIONS



SCALE 4:1

**UDFN8, 1.7x1.35, 0.4P**  
CASE 517BC  
ISSUE A

DATE 11 AUG 2022

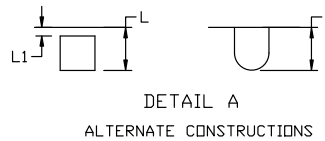
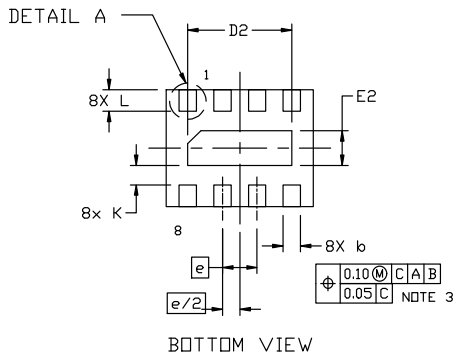
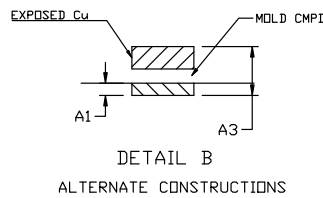
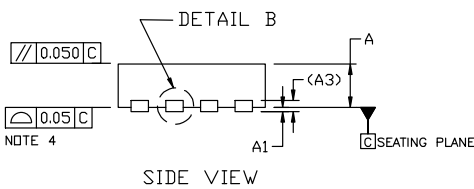
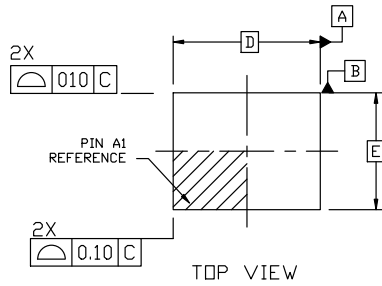

NOTES:

1. DIMENSIONING AND TOLERANCING PER ASME Y14.5M, 2004.
2. CONTROLLING DIMENSION: MILLIMETERS.
3. DIMENSION b APPLIES TO PLATED TERMINAL AND IS MEASURED BETWEEN 0.15 AND 0.25MM FROM THE TERMINAL TIP.
4. COPLANARITY APPLIES TO THE EXPOSED PADS AS WELL AS THE TERMINALS.

| DIM | MILLIMETERS |      |
|-----|-------------|------|
|     | MIN.        | MAX. |
| A   | 0.45        | 0.55 |
| A1  | 0.00        | 0.05 |
| A3  | 0.13 REF    |      |
| b   | 0.15        | 0.25 |
| D   | 1.70 BSC    |      |
| D2  | 1.10        | 1.30 |
| E   | 1.35 BSC    |      |
| E2  | 0.30        | 0.50 |
| e   | 0.40 BSC    |      |
| K   | 0.15        | ---  |
| L   | 0.20        | 0.30 |
| L1  | ---         | 0.05 |

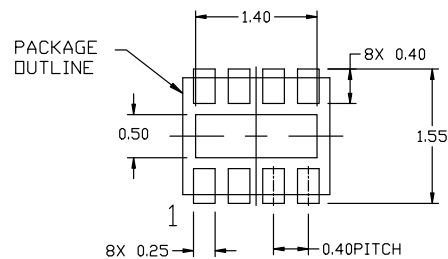

**GENERIC MARKING DIAGRAMS\***



- XXX = Specific Device Code
- M = Date Code
- = Pb-Free Package

(Note: Microdot may be in either location)

\*This information is generic. Please refer to device data sheet for actual part marking. Pb-Free indicator, "G" or microdot "▪", may or may not be present. Some products may not follow the Generic Marking.

\* For additional information on our Pb-Free strategy and soldering details, please download the [EN Semiconductor Soldering and Mounting Techniques Reference Manual, SOLDERM/D](#).

|                         |                              |  |
|-------------------------|------------------------------|--|
| <b>DOCUMENT NUMBER:</b> | <b>98AON47060E</b>           | Electronic versions are uncontrolled except when accessed directly from the Document Repository. Printed versions are uncontrolled except when stamped "CONTROLLED COPY" in red. |
| <b>DESCRIPTION:</b>     | <b>UDFN8, 1.7x1.35, 0.4P</b> | <b>PAGE 1 OF 1</b>   |

onsemi and onsemi are trademarks of Semiconductor Components Industries, LLC dba onsemi or its subsidiaries in the United States and/or other countries. onsemi reserves the right to make changes without further notice to any products herein. onsemi makes no warranty, representation or guarantee regarding the suitability of its products for any particular purpose, nor does onsemi assume any liability arising out of the application or use of any product or circuit, and specifically disclaims any and all liability, including without limitation special, consequential or incidental damages. onsemi does not convey any license under its patent rights nor the rights of others.

**onsemi**, **Onsemi**, and other names, marks, and brands are registered and/or common law trademarks of Semiconductor Components Industries, LLC dba "**onsemi**" or its affiliates and/or subsidiaries in the United States and/or other countries. **onsemi** owns the rights to a number of patents, trademarks, copyrights, trade secrets, and other intellectual property. A listing of **onsemi**'s product/patent coverage may be accessed at [www.onsemi.com/site/pdf/Patent-Marking.pdf](http://www.onsemi.com/site/pdf/Patent-Marking.pdf). **onsemi** reserves the right to make changes at any time to any products or information herein, without notice. The information herein is provided "as-is" and **onsemi** makes no warranty, representation or guarantee regarding the accuracy of the information, product features, availability, functionality, or suitability of its products for any particular purpose, nor does **onsemi** assume any liability arising out of the application or use of any product or circuit, and specifically disclaims any and all liability, including without limitation special, consequential or incidental damages. Buyer is responsible for its products and applications using **onsemi** products, including compliance with all laws, regulations and safety requirements or standards, regardless of any support or applications information provided by **onsemi**. "Typical" parameters which may be provided in **onsemi** data sheets and/or specifications can and do vary in different applications and actual performance may vary over time. All operating parameters, including "Typicals" must be validated for each customer application by customer's technical experts. **onsemi** does not convey any license under any of its intellectual property rights nor the rights of others. **onsemi** products are not designed, intended, or authorized for use as a critical component in life support systems or any FDA Class 3 medical devices or medical devices with a same or similar classification in a foreign jurisdiction or any devices intended for implantation in the human body. Should Buyer purchase or use **onsemi** products for any such unintended or unauthorized application, Buyer shall indemnify and hold **onsemi** and its officers, employees, subsidiaries, affiliates, and distributors harmless against all claims, costs, damages, and expenses, and reasonable attorney fees arising out of, directly or indirectly, any claim of personal injury or death associated with such unintended or unauthorized use, even if such claim alleges that **onsemi** was negligent regarding the design or manufacture of the part. **onsemi** is an Equal Opportunity/Affirmative Action Employer. This literature is subject to all applicable copyright laws and is not for resale in any manner.

## PUBLICATION ORDERING INFORMATION

### LITERATURE FULFILLMENT:

Email Requests to: [orderlit@onsemi.com](mailto:orderlit@onsemi.com)

**onsemi Website:** [www.onsemi.com](http://www.onsemi.com)

### TECHNICAL SUPPORT

**North American Technical Support:**

Voice Mail: 1 800-282-9855 Toll Free USA/Canada

Phone: 011 421 33 790 2910

**Europe, Middle East and Africa Technical Support:**

Phone: 00421 33 790 2910

For additional information, please contact your local Sales Representative