

Important notice

Dear Customer,

On 7 February 2017 the former NXP Standard Product business became a new company with the tradename **Nexperia**. Nexperia is an industry leading supplier of Discrete, Logic and PowerMOS semiconductors with its focus on the automotive, industrial, computing, consumer and wearable application markets

In data sheets and application notes which still contain NXP or Philips Semiconductors references, use the references to Nexperia, as shown below.

Instead of <http://www.nxp.com>, <http://www.philips.com/> or <http://www.semiconductors.philips.com/>, use <http://www.nexperia.com>

Instead of sales.addresses@www.nxp.com or sales.addresses@www.semiconductors.philips.com, use salesaddresses@nexperia.com (email)

Replace the copyright notice at the bottom of each page or elsewhere in the document, depending on the version, as shown below:

- © NXP N.V. (year). All rights reserved or © Koninklijke Philips Electronics N.V. (year). All rights reserved

Should be replaced with:

- © **Nexperia B.V. (year). All rights reserved.**

If you have any questions related to the data sheet, please contact our nearest sales office via e-mail or telephone (details via salesaddresses@nexperia.com). Thank you for your cooperation and understanding,

Kind regards,

Team Nexperia

IP4337CX18/LF

7-channel integrated filter network with ESD input protection
to IEC 61000-4-2 level 4

Rev. 02 — 20 August 2009

Product data sheet

1. Product profile

1.1 General description

The IP4337CX18/LF is a 7-channel RC low-pass filter array which is designed to provide filtering of undesired RF signals in the 800 MHz to 3000 MHz frequency band. In addition, the IP4337CX18/LF incorporates diodes to provide protection to downstream components from ElectroStatic Discharge (ESD) voltages as high as ± 15 kV.

The IP4337CX18/LF is fabricated using monolithic silicon technology and integrates 7 resistors and 14 diodes in a single Wafer-Level Chip-Scale Package (WLCSP) measuring 1.96 mm by 1.61 mm (typical). These features make the IP4337CX18/LF ideal for use in applications requiring the utmost in miniaturization.

1.2 Features

- Pb-free, RoHS compliant and free of halogen and antimony (Dark Green compliant)
- Integrated 7-channel π -type RC filter network
- 70 Ω series resistance; 25 pF (typical) capacitance per line
- Integrated ESD protection withstanding ± 15 kV contact discharge, far exceeding IEC 61000-4-2 level 4
- WLCSP with 0.4 mm pitch

1.3 Applications

- Cellular and Personal Communication System (PCS) mobile handsets
- Cordless telephones
- Wireless data (WAN/LAN) systems

2. Pinning information

2.1 Pinning

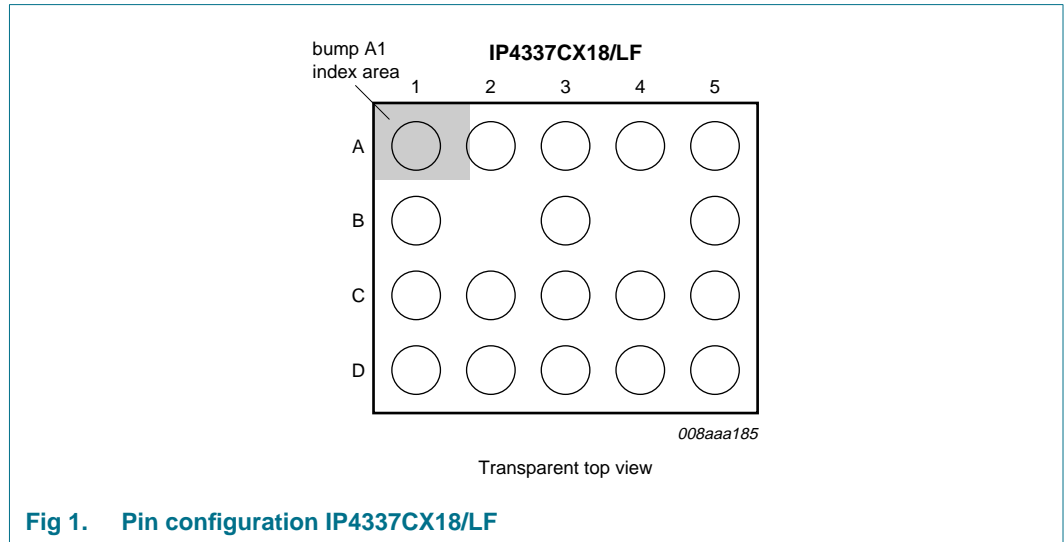

Fig 1. Pin configuration IP4337CX18/LF

2.2 Pin description

Table 1. Pinning

Pin	Description
A2 and A5	filter channel 1
A1 and A4	filter channel 2
B1 and B5	filter channel 3
C2 and C5	filter channel 4
C1 and C4	filter channel 5
D2 and D5	filter channel 6
D1 and D4	filter channel 7
A3, B3, C3, D3	ground
B2 and B4	no balls

3. Ordering information

Table 2. Ordering information

Type number	Package		
	Name	Description	Version
IP4337CX18/LF	WL CSP18	wafer level chip-size package; 18 bumps; 1.96 × 1.61 × 0.61 mm	IP4337CX18/LF

4. Functional diagram

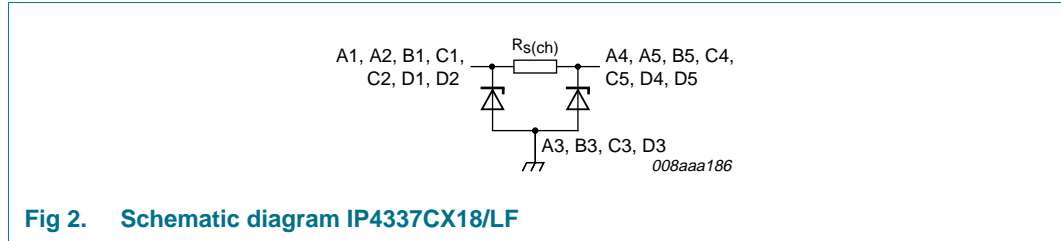

Fig 2. Schematic diagram IP4337CX18/LF

5. Limiting values

Table 3. Limiting values

In accordance with the Absolute Maximum Rating System (IEC 60134).

Symbol	Parameter	Conditions	Min	Max	Unit	
V _I	input voltage		-0.5	+5.5	V	
V _{ESD}	electrostatic discharge voltage	all pins to ground				
		contact discharge	[1]	-15	+15	kV
		air discharge	[1]	-15	+15	kV
		IEC 61000-4-2 level 4; all pins to ground				
		contact discharge		-8	+8	kV
		air discharge		-15	+15	kV
I _{ch}	channel current (DC)	T _{amb} = 70 °C	-	33	mA	
P _{ch}	channel power dissipation	continuous power; T _{amb} = 70 °C	-	60	mW	
P _{tot}	total power dissipation	continuous power; T _{amb} = 70 °C	-	250	mW	
T _{stg}	storage temperature		-55	+150	°C	
T _{reflow(peak)}	peak reflow temperature	10 s maximum	-	260	°C	
T _{amb}	ambient temperature		-30	+85	°C	

[1] Device is qualified with 1000 pulses of ±15 kV contact discharges each, according to the IEC 61000-4-2 model and far exceeds the specified level 4 (8 kV contact discharge).

6. Characteristics

Table 4. Channel characteristics

$T_{amb} = 25\text{ }^{\circ}\text{C}$; unless otherwise specified.

Symbol	Parameter	Conditions	Min	Typ	Max	Unit
$R_{s(ch)}$	channel series resistance	$f = 0\text{ Hz (DC)}$	52.5	70	87.5	Ω
C_{ch}	channel capacitance	$V_{bias(DC)} = 0\text{ V}$; $f = 1\text{ MHz}$ [1]	-	25	30	pF
V_{BR}	breakdown voltage	$I_{test} = 1\text{ mA}$	6	-	20	V
I_{LR}	reverse leakage current	per channel; $V_I = 3.0\text{ V}$	-	-	20	nA

[1] Guaranteed by design.

Table 5. Frequency characteristics

$T_{amb} = 25\text{ }^{\circ}\text{C}$; unless otherwise specified.

Symbol	Parameter	Conditions	Min	Typ	Max	Unit
α_{il}	insertion loss	$800\text{ MHz} < f < 3\text{ GHz}$; $R_{gen} = 50\ \Omega$; $R_L = 50\ \Omega$	-	20	-	dB
α_{ct}	crosstalk attenuation	$800\text{ MHz} < f < 3\text{ GHz}$; $R_{gen} = 50\ \Omega$; $R_L = 50\ \Omega$	-	25	-	dB

7. Application information

7.1 Insertion loss

The insertion loss measurement configuration of a typical 50 Ω NetWork Analyzer (NWA) system for evaluation of the IP4337CX18/LF is shown in [Figure 3](#).

As an example, the insertion loss of channels between pins A2 and A5, A1 and A4, B1 and B5, C1 and C4 at frequencies up to 6 GHz is displayed in [Figure 4](#).

The insertion loss is measured with a test PCB utilizing laser drilled micro-via holes that connect the PCB ground plane to the IP4337CX18/LF ground pins.

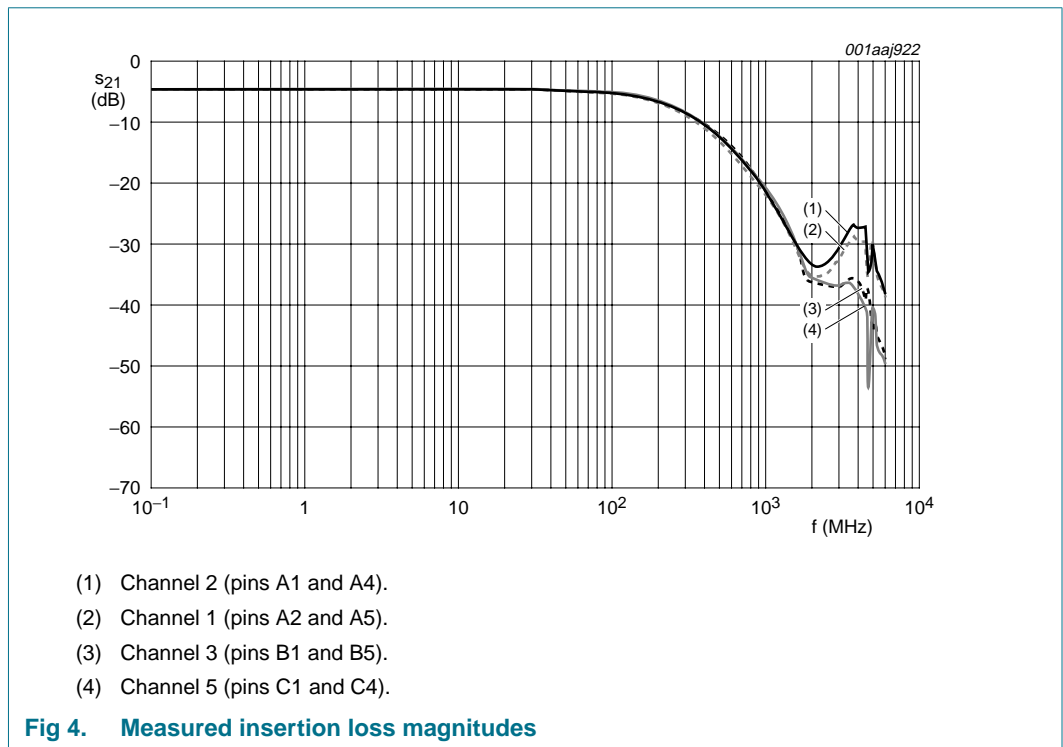
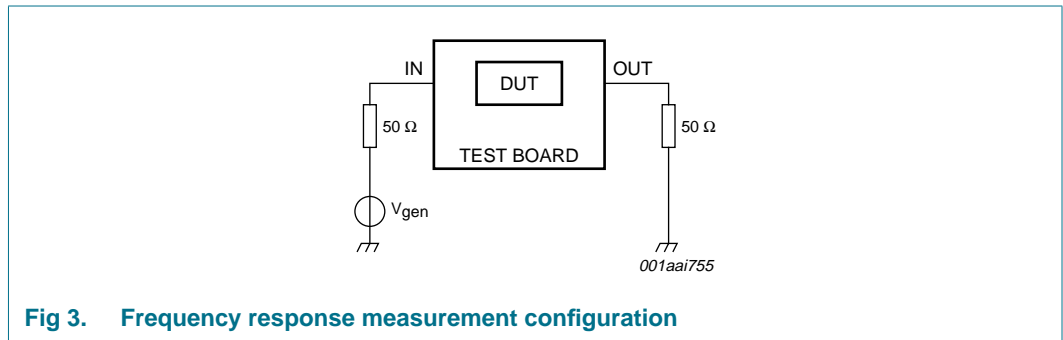

7.2 Crosstalk

The crosstalk measurement configuration of a typical 50 Ω NWA system for evaluation of the IP4337CX18/LF is shown in [Figure 5](#).

The measured crosstalk within the IP4337CX18/LF in a 50 Ω NWA system from one channel to another is shown in [Figure 6](#) for four different pairs of channels. In all cases, unused connections are terminated with 50 Ω to ground.

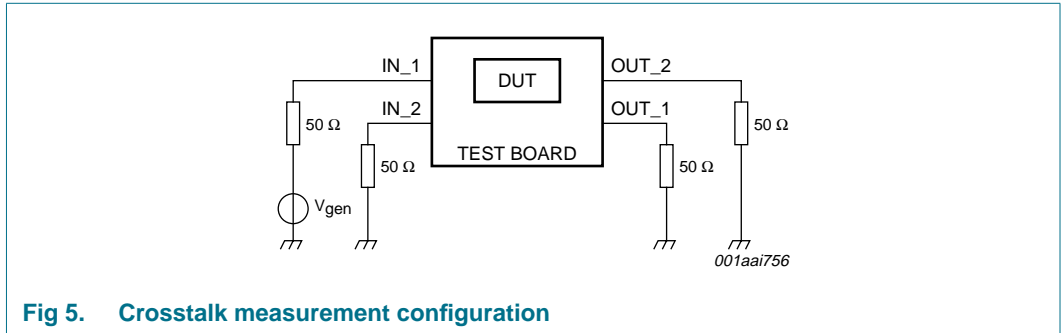

Fig 5. Crosstalk measurement configuration

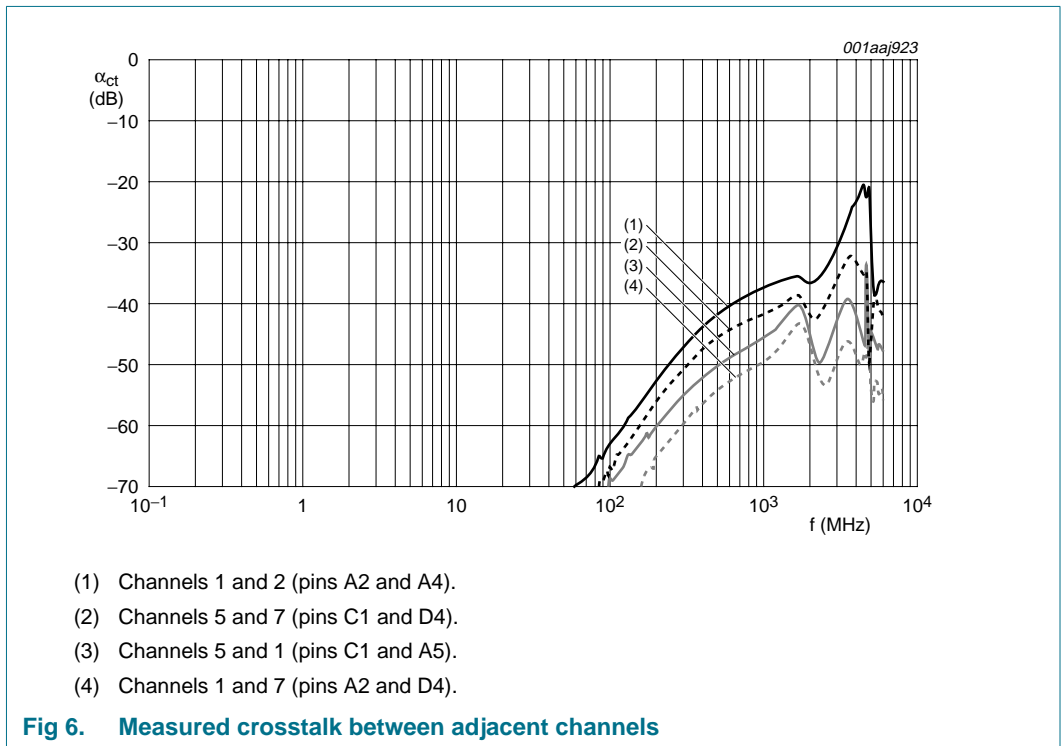

Fig 6. Measured crosstalk between adjacent channels

8. Package outline

WLCSP18: wafer level chip-size package; 18 bumps; 1.96 x 1.61 x 0.61 mm

IP4337CX18/LF

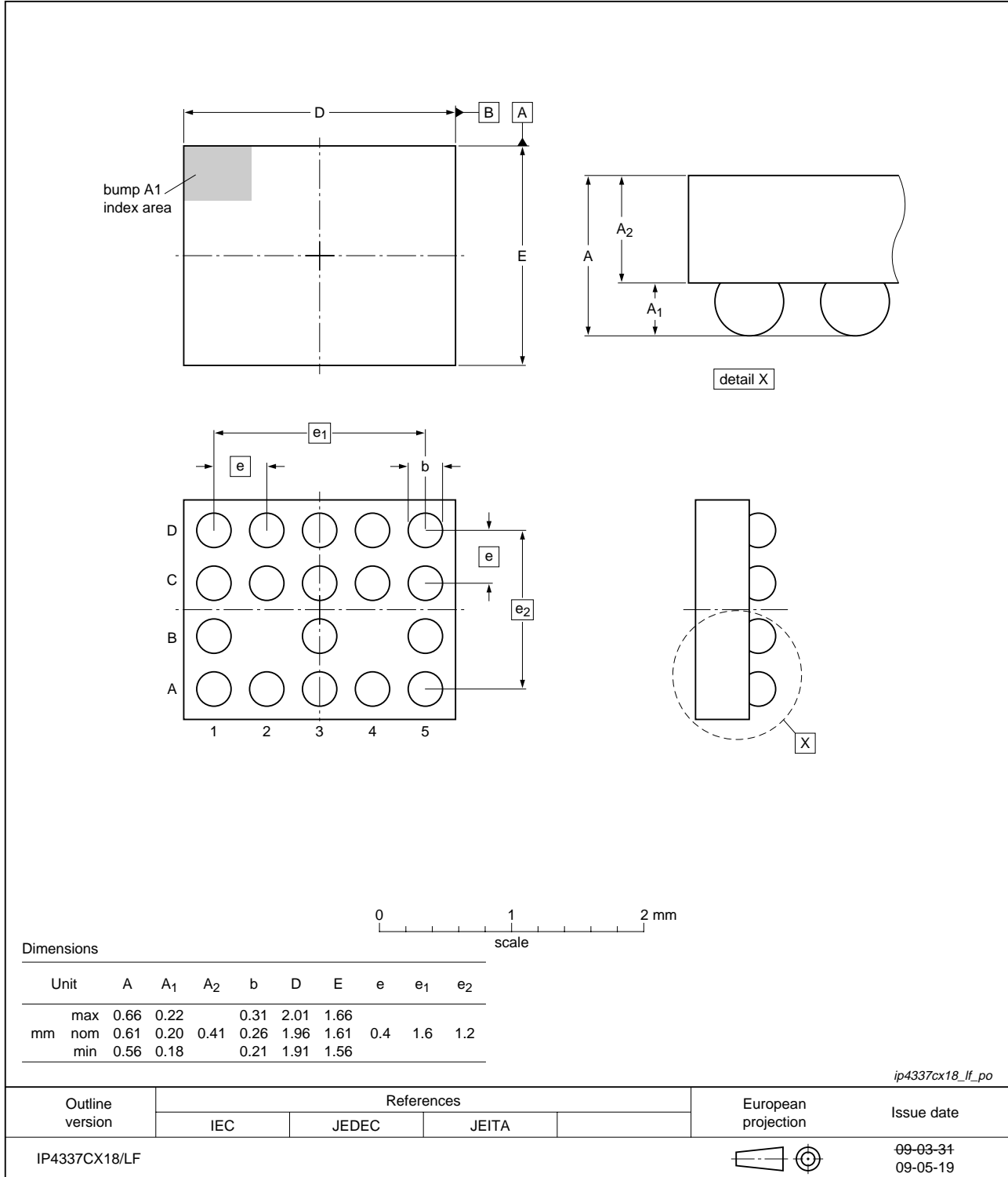

Fig 7. Package outline IP4337CX18/LF (WLCSP18)

9. Soldering of WLCSP packages

9.1 Introduction to soldering WLCSP packages

This text provides a very brief insight into a complex technology. A more in-depth account of soldering WLCSP (Wafer Level Chip-Size Packages) can be found in application note AN10439 "Wafer Level Chip Scale Package" and in application note AN10365 "Surface mount reflow soldering description".

Wave soldering is not suitable for this package.

All NXP WLCSP packages are lead-free.

9.2 Board mounting

Board mounting of a WLCSP requires several steps:

1. Solder paste printing on the PCB
2. Component placement with a pick and place machine
3. The reflow soldering itself

9.3 Reflow soldering

Key characteristics in reflow soldering are:

- Lead-free versus SnPb soldering; note that a lead-free reflow process usually leads to higher minimum peak temperatures (see [Figure 8](#)) than a PbSn process, thus reducing the process window
- Solder paste printing issues, such as smearing, release, and adjusting the process window for a mix of large and small components on one board
- Reflow temperature profile; this profile includes preheat, reflow (in which the board is heated to the peak temperature), and cooling down. It is imperative that the peak temperature is high enough for the solder to make reliable solder joints (a solder paste characteristic) while being low enough that the packages and/or boards are not damaged. The peak temperature of the package depends on package thickness and volume and is classified in accordance with [Table 6](#).

Table 6. Lead-free process (from J-STD-020C)

Package thickness (mm)	Package reflow temperature (°C)		
	Volume (mm ³)		
	< 350	350 to 2000	> 2000
< 1.6	260	260	260
1.6 to 2.5	260	250	245
> 2.5	250	245	245

Moisture sensitivity precautions, as indicated on the packing, must be respected at all times.

Studies have shown that small packages reach higher temperatures during reflow soldering, see [Figure 8](#).

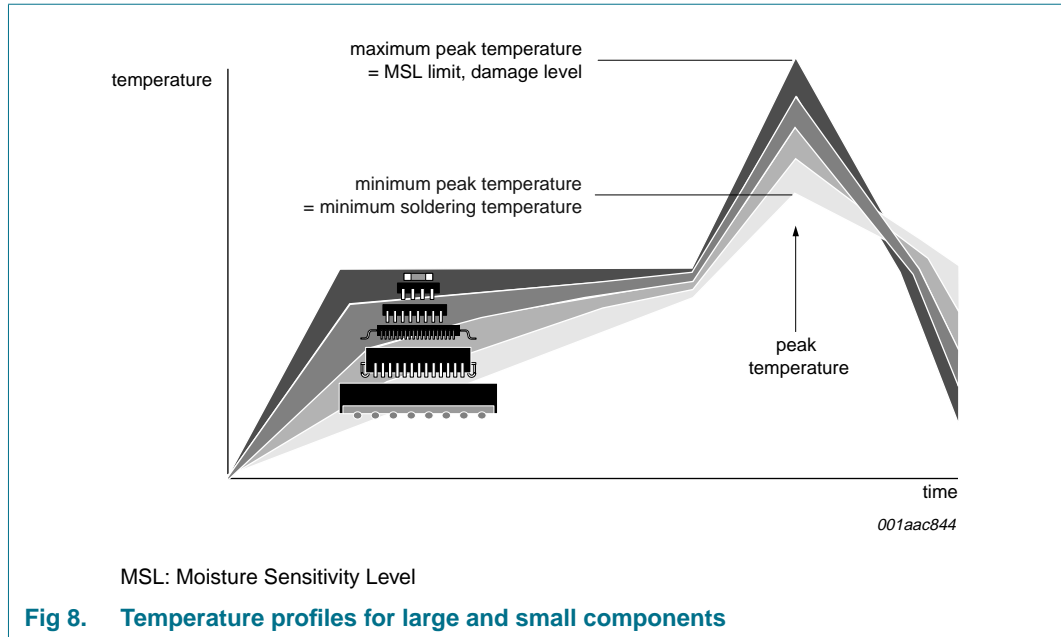

For further information on temperature profiles, refer to application note AN10365 “Surface mount reflow soldering description”.

9.3.1 Stand off

The stand off between the substrate and the chip is determined by:

- The amount of printed solder on the substrate
- The size of the solder land on the substrate
- The bump height on the chip

The higher the stand off, the better the stresses are released due to TEC (Thermal Expansion Coefficient) differences between substrate and chip.

9.3.2 Quality of solder joint

A flip-chip joint is considered to be a good joint when the entire solder land has been wetted by the solder from the bump. The surface of the joint should be smooth and the shape symmetrical. The soldered joints on a chip should be uniform. Voids in the bumps after reflow can occur during the reflow process in bumps with high ratio of bump diameter to bump height, i.e. low bumps with large diameter. No failures have been found to be related to these voids. Solder joint inspection after reflow can be done with X-ray to monitor defects such as bridging, open circuits and voids.

9.3.3 Rework

In general, rework is not recommended. By rework we mean the process of removing the chip from the substrate and replacing it with a new chip. If a chip is removed from the substrate, most solder balls of the chip will be damaged. In that case it is recommended not to re-use the chip again.

Device removal can be done when the substrate is heated until it is certain that all solder joints are molten. The chip can then be carefully removed from the substrate without damaging the tracks and solder lands on the substrate. Removing the device must be done using plastic tweezers, because metal tweezers can damage the silicon. The surface of the substrate should be carefully cleaned and all solder and flux residues and/or underfill removed. When a new chip is placed on the substrate, use the flux process instead of solder on the solder lands. Apply flux on the bumps at the chip side as well as on the solder pads on the substrate. Place and align the new chip while viewing with a microscope. To reflow the solder, use the solder profile shown in application note AN10365 “Surface mount reflow soldering description”.

9.3.4 Cleaning

Cleaning can be done after reflow soldering.

10. Abbreviations

Table 7. Abbreviations

Acronym	Description
DUT	Device Under Test
ESD	ElectroStatic Discharge
LAN	Local Area Network
NWA	NetWork Analyzer
PCB	Printed-Circuit Board
PCS	Personal Communication System
RoHS	Restriction of Hazardous Substances
WAN	Wide Area Network
WLCSP	Wafer-Level Chip-Scale Package

11. Revision history

Table 8. Revision history

Document ID	Release date	Data sheet status	Change notice	Supersedes
IP4337CX18LF_2	20090820	Product data sheet	-	IP4337CX18LF_1
Modifications:	<ul style="list-style-type: none"> • Figure 4: figure title and symbol changed 			
IP4337CX18LF_1	20090618	Product data sheet	-	-

12. Legal information

12.1 Data sheet status

Document status ^{[1][2]}	Product status ^[3]	Definition
Objective [short] data sheet	Development	This document contains data from the objective specification for product development.
Preliminary [short] data sheet	Qualification	This document contains data from the preliminary specification.
Product [short] data sheet	Production	This document contains the product specification.

[1] Please consult the most recently issued document before initiating or completing a design.

[2] The term 'short data sheet' is explained in section "Definitions".

[3] The product status of device(s) described in this document may have changed since this document was published and may differ in case of multiple devices. The latest product status information is available on the Internet at URL <http://www.nxp.com>.

12.2 Definitions

Draft — The document is a draft version only. The content is still under internal review and subject to formal approval, which may result in modifications or additions. NXP Semiconductors does not give any representations or warranties as to the accuracy or completeness of information included herein and shall have no liability for the consequences of use of such information.

Short data sheet — A short data sheet is an extract from a full data sheet with the same product type number(s) and title. A short data sheet is intended for quick reference only and should not be relied upon to contain detailed and full information. For detailed and full information see the relevant full data sheet, which is available on request via the local NXP Semiconductors sales office. In case of any inconsistency or conflict with the short data sheet, the full data sheet shall prevail.

12.3 Disclaimers

General — Information in this document is believed to be accurate and reliable. However, NXP Semiconductors does not give any representations or warranties, expressed or implied, as to the accuracy or completeness of such information and shall have no liability for the consequences of use of such information.

Right to make changes — NXP Semiconductors reserves the right to make changes to information published in this document, including without limitation specifications and product descriptions, at any time and without notice. This document supersedes and replaces all information supplied prior to the publication hereof.

Suitability for use — NXP Semiconductors products are not designed, authorized or warranted to be suitable for use in medical, military, aircraft, space or life support equipment, nor in applications where failure or malfunction of an NXP Semiconductors product can reasonably be expected to result in personal injury, death or severe property or environmental

damage. NXP Semiconductors accepts no liability for inclusion and/or use of NXP Semiconductors products in such equipment or applications and therefore such inclusion and/or use is at the customer's own risk.

Applications — Applications that are described herein for any of these products are for illustrative purposes only. NXP Semiconductors makes no representation or warranty that such applications will be suitable for the specified use without further testing or modification.

Limiting values — Stress above one or more limiting values (as defined in the Absolute Maximum Ratings System of IEC 60134) may cause permanent damage to the device. Limiting values are stress ratings only and operation of the device at these or any other conditions above those given in the Characteristics sections of this document is not implied. Exposure to limiting values for extended periods may affect device reliability.

Terms and conditions of sale — NXP Semiconductors products are sold subject to the general terms and conditions of commercial sale, as published at <http://www.nxp.com/profile/terms>, including those pertaining to warranty, intellectual property rights infringement and limitation of liability, unless explicitly otherwise agreed to in writing by NXP Semiconductors. In case of any inconsistency or conflict between information in this document and such terms and conditions, the latter will prevail.

No offer to sell or license — Nothing in this document may be interpreted or construed as an offer to sell products that is open for acceptance or the grant, conveyance or implication of any license under any copyrights, patents or other industrial or intellectual property rights.

Export control — This document as well as the item(s) described herein may be subject to export control regulations. Export might require a prior authorization from national authorities.

12.4 Trademarks

Notice: All referenced brands, product names, service names and trademarks are the property of their respective owners.

13. Contact information

For more information, please visit: <http://www.nxp.com>

For sales office addresses, please send an email to: salesaddresses@nxp.com

14. Contents

1 Product profile 1

1.1 General description 1

1.2 Features 1

1.3 Applications 1

2 Pinning information 2

2.1 Pinning 2

2.2 Pin description 2

3 Ordering information 2

4 Functional diagram 3

5 Limiting values 3

6 Characteristics 4

7 Application information 5

7.1 Insertion loss 5

7.2 Crosstalk 6

8 Package outline 7

9 Soldering of WLCSP packages 8

9.1 Introduction to soldering WLCSP packages . . . 8

9.2 Board mounting 8

9.3 Reflow soldering 8

9.3.1 Stand off 9

9.3.2 Quality of solder joint 9

9.3.3 Rework 9

9.3.4 Cleaning 10

10 Abbreviations 10

11 Revision history 10

12 Legal information 11

12.1 Data sheet status 11

12.2 Definitions 11

12.3 Disclaimers 11

12.4 Trademarks 11

13 Contact information 11

14 Contents 12

Please be aware that important notices concerning this document and the product(s) described herein, have been included in section 'Legal information'.



© NXP B.V. 2009. **All rights reserved.**
 For more information, please visit: <http://www.nxp.com>
 For sales office addresses, please send an email to: salesaddresses@nxp.com
 Date of release: 20 August 2009
 Document identifier: IP4337CX18LF_2