

## Important notice

Dear Customer,

On 7 February 2017 the former NXP Standard Product business became a new company with the tradename **Nexperia**. Nexperia is an industry leading supplier of Discrete, Logic and PowerMOS semiconductors with its focus on the automotive, industrial, computing, consumer and wearable application markets

In data sheets and application notes which still contain NXP or Philips Semiconductors references, use the references to Nexperia, as shown below.

Instead of <http://www.nxp.com>, <http://www.philips.com/> or <http://www.semiconductors.philips.com/>, use <http://www.nexperia.com>

Instead of [sales.addresses@www.nxp.com](mailto:sales.addresses@www.nxp.com) or [sales.addresses@www.semiconductors.philips.com](mailto:sales.addresses@www.semiconductors.philips.com), use [salesaddresses@nexperia.com](mailto:salesaddresses@nexperia.com) (email)

Replace the copyright notice at the bottom of each page or elsewhere in the document, depending on the version, as shown below:

- © NXP N.V. (year). All rights reserved or © Koninklijke Philips Electronics N.V. (year). All rights reserved

Should be replaced with:

- © **Nexperia B.V. (year). All rights reserved.**

If you have any questions related to the data sheet, please contact our nearest sales office via e-mail or telephone (details via [salesaddresses@nexperia.com](mailto:salesaddresses@nexperia.com)). Thank you for your cooperation and understanding,

Kind regards,

Team Nexperia

# PEMIxQFN; PEMI2STD family

Integrated 1-, 2-, 4-, 6- and 8-channel passive filter network with ESD protection

Rev. 2 — 3 November 2011

Product data sheet

## 1. Product profile

### 1.1 General description

The devices are a family of RC low pass filters. They are designed to provide filtering of undesired RF signals on the I/O ports of portable communication or computing devices. The devices incorporate diodes to provide protection to downstream components from ElectroStatic Discharge (ESD) voltages up to  $\pm 25$  kV.

The devices are fabricated using monolithic silicon technology in lead-free plastic packages.

Table 1. Product overview

Type number	Package	Number of channels	Package pitch (mm)	Package configuration
PEMI1QFN	SOT883	1	-	3-pin MicroPak (QFN compatible)
PEMI2QFN	SOT886	2	0.5	6-pin MicroPak (QFN compatible)
PEMI2STD	SOT665	1	-	5-pin microlead
PEMI4QFN	SOT1157-1	4	0.4	8-pin extremely thin leadless
PEMI6QFN	SOT1158-1	6	0.4	12-pin extremely thin leadless
PEMI8QFN	SOT1159-1	8	0.4	16-pin extremely thin leadless

### 1.2 Features and benefits

- Pb-free, Restriction of Hazardous Substances (RoHS) compliant and free of halogen and antimony (Dark Green compliant)
- Integrated 1-, 2-, 4-, 6- and 8-channel  $\pi$ -type RC filter network
- ESD protection up to  $\pm 25$  kV contact discharge according to IEC 61000-4-2, far exceeding level 4

### 1.3 Applications

General-purpose ElectroMagnetic Interference (EMI) and Radio-Frequency Interference (RFI) filtering and downstream ESD protection for:

- Cellular phone and Personal Communication Systems (PCS) mobile handsets
- Cordless telephones
- Wireless data (WAN/LAN) systems



## 1.4 Quick reference data

**Table 2. Quick reference data**

Symbol	Parameter	Conditions	Typ	Unit
$R_{s(ch)}$	channel series resistance			
	PEM1xxx/Cx		20	$\Omega$
	PEM1xxx/Hx		45	$\Omega$
	PEM1xxx/Lx		65	$\Omega$
	PEM1xxx/Rx		100	$\Omega$
	PEM1xxx/Wx		200	$\Omega$
$C_{ch}$	channel capacitance	for the total channel; $f = 100 \text{ kHz}; V_{bias(DC)} = 0 \text{ V}$		
	PEM1xxx/xE		15	pF
	PEM1xxx/xG		19	pF
	PEM1xxx/xK		23	pF
	PEM1xxx/xM		28	pF
	PEM1xxx/xP		32	pF
	PEM1xxx/xR		36	pF
	PEM1xxx/xT		40	pF

## 2. Pinning information

**Table 3. Pinning**

Pin	Description	Simplified outline	Graphic symbol
<b>PEM1QFN (SOT883)</b>			
1 and 2	filter channel	<p>Transparent top view</p>	<p>018aaa042</p>
3	ground (GND)		
<b>PEM2QFN (SOT886)</b>			
1 and 6	filter channel 1	<p>Transparent top view</p>	<p>018aaa044</p>
2 and 5	ground (GND)		
3 and 4	filter channel 2		

**Table 3. Pinning ...continued**

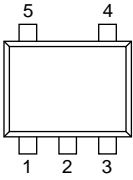
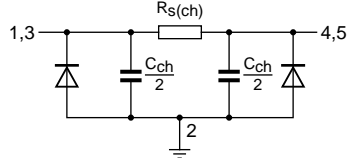
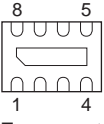
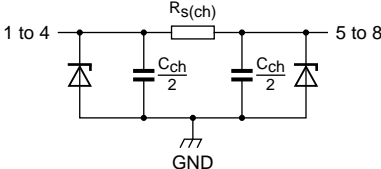
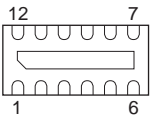
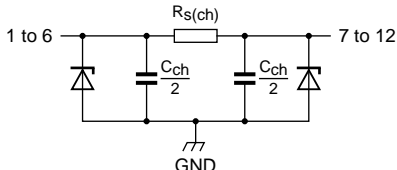
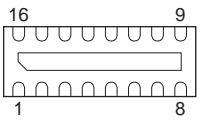
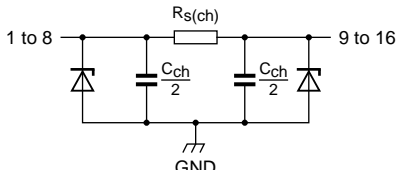
Pin	Description	Simplified outline	Graphic symbol
<b>PEMI2STD (SOT665)</b>			
1 and 5	filter channel 1		 <p style="text-align: right;">018aaa043</p>
2	ground (GND)		
3 and 4	filter channel 2		
<b>PEMI4QFN (SOT1157-1)</b>			
1 and 8	filter channel 1	 <p style="text-align: center;">Transparent top view</p>	 <p style="text-align: right;">018aaa071</p>
2 and 7	filter channel 2		
3 and 6	filter channel 3		
4 and 5	filter channel 4		
ground pad	ground (GND)		
<b>PEMI6QFN (SOT1158-1)</b>			
1 and 12	filter channel 1	 <p style="text-align: center;">Transparent top view</p>	 <p style="text-align: right;">018aaa072</p>
2 and 11	filter channel 2		
3 and 10	filter channel 3		
4 and 9	filter channel 4		
5 and 8	filter channel 5		
6 and 7	filter channel 6		
ground pad	ground (GND)		
<b>PEMI8QFN (SOT1159-1)</b>			
1 and 16	filter channel 1	 <p style="text-align: center;">Transparent top view</p>	 <p style="text-align: right;">018aaa073</p>
2 and 15	filter channel 2		
3 and 14	filter channel 3		
4 and 13	filter channel 4		
5 and 12	filter channel 5		
6 and 11	filter channel 6		
7 and 10	filter channel 7		
8 and 9	filter channel 8		
ground pad	ground (GND)		

### 3. Ordering information

Table 4. Ordering information

Type number	Package		Version
	Name	Description	
PEMI1QFN	SC-101	leadless ultra small plastic package; 3 solder lands; body 1.0 × 0.6 × 0.5 mm	SOT883
PEMI2QFN	XSON6	plastic extremely thin small outline package; no leads; 6 terminals; body 1 × 1.45 × 0.5 mm	SOT886
PEMI2STD	-	plastic surface-mounted package; 5 leads	SOT665
PEMI4QFN	HXSON8	plastic thermal enhanced extremely thin small outline package; no leads; 8 terminals; body 1.2 × 1.7 × 0.5 mm	SOT1157-1
PEMI6QFN	HXSON12	plastic thermal enhanced extremely thin small outline package; no leads; 12 terminals; body 1.2 × 2.5 × 0.5 mm	SOT1158-1
PEMI8QFN	HXSON16	plastic thermal enhanced extremely thin small outline package; no leads; 16 terminals; body 1.2 × 3.3 × 0.5 mm	SOT1159-1

### 4. Limiting values

Table 5. Limiting values

In accordance with the Absolute Maximum Rating System (IEC 60134).

Symbol	Parameter	Conditions	Min	Max	Unit
$V_{CC}$	supply voltage		-0.5	+5.6	V
$V_{ESD}$	electrostatic discharge voltage	IEC 61000-4-2, level 4 all pins to ground			
		contact discharge	-	±15	kV
		air discharge	-	±15	kV
	PEMIxxxx/xM; PEMIxxxx/xP	contact discharge	-	±20	kV
		air discharge	-	±20	kV
	PEMIxxxx/xR; PEMIxxxx/xT	contact discharge	-	±25	kV
air discharge		-	±25	kV	
$P_{ch}$	channel power dissipation	continuous power; $T_{amb} = 85\text{ °C}$	-	60	mW
$P_{tot}$	total power dissipation	continuous power; $T_{amb} = 85\text{ °C}$	-	120	mW
$T_{stg}$	storage temperature		-55	+150	°C
$T_{amb}$	ambient temperature		-40	+85	°C

## 5. Characteristics

**Table 6. Channel characteristics**

$T_{amb} = 25\text{ }^{\circ}\text{C}$ ; unless otherwise specified.

Symbol	Parameter	Conditions	Min	Typ	Max	Unit	
$R_{s(ch)}$	channel series resistance						
	PEMIxxxx/Cx		18	20	22	$\Omega$	
	PEMIxxxx/Hx		40	45	50	$\Omega$	
	PEMIxxxx/Lx		58	65	72	$\Omega$	
	PEMIxxxx/Rx		90	100	110	$\Omega$	
	PEMIxxxx/Wx		180	200	220	$\Omega$	
$C_{ch}$	channel capacitance	for the total channel; $f = 100\text{ kHz}$					
	PEMIxxxx/xE	$V_{bias(DC)} = 0\text{ V}$	-	15	-	pF	
		$V_{bias(DC)} = 2.5\text{ V}$	-	8.5	-	pF	
	PEMIxxxx/xG	$V_{bias(DC)} = 0\text{ V}$	-	19	-	pF	
		$V_{bias(DC)} = 2.5\text{ V}$	-	11	-	pF	
	PEMIxxxx/xK	$V_{bias(DC)} = 0\text{ V}$	-	23	-	pF	
		$V_{bias(DC)} = 2.5\text{ V}$	-	13.5	-	pF	
	PEMIxxxx/xM	$V_{bias(DC)} = 0\text{ V}$	-	28	-	pF	
		$V_{bias(DC)} = 2.5\text{ V}$	-	16	-	pF	
	PEMIxxxx/xP	$V_{bias(DC)} = 0\text{ V}$	-	32	-	pF	
		$V_{bias(DC)} = 2.5\text{ V}$	-	18.5	-	pF	
	PEMIxxxx/xR	$V_{bias(DC)} = 0\text{ V}$	-	36	-	pF	
		$V_{bias(DC)} = 2.5\text{ V}$	-	21	-	pF	
	PEMIxxxx/xT	$V_{bias(DC)} = 0\text{ V}$	-	40	-	pF	
		$V_{bias(DC)} = 2.5\text{ V}$	-	23	-	pF	
	$V_{BR}$	breakdown voltage	positive clamp; $I_I = 1\text{ mA}$	5.8	-	9	V
	$V_F$	forward voltage	negative clamp; $I_F = 1\text{ mA}$	-1.5	-	-0.4	V
	$I_{LR}$	reverse leakage current	per channel; $V_I = 3.5\text{ V}$	-	-	0.1	$\mu\text{A}$

**Table 7. Frequency characteristics** $T_{amb} = 25\text{ }^{\circ}\text{C}$ ; unless otherwise specified;  $R_{source} = 50\ \Omega$ ;  $R_L = 50\ \Omega$ .

Symbol	Parameter	Conditions	Min	Typ	Max	Unit		
$\alpha_{ij}$	insertion loss	$C_{ch} = 15\text{ pF}$						
							PEMlxxxx/CE	$R_{S(ch)} = 20\ \Omega$
				800 MHz < f < 3 GHz	7	-	-	dB
				f = 5 GHz	-	30	-	dB
	PEMlxxxx/HE	$R_{S(ch)} = 45\ \Omega$						
								800 MHz < f < 3 GHz
				f = 4 GHz	-	31	-	dB
	PEMlxxxx/LE	$R_{S(ch)} = 65\ \Omega$						
								800 MHz < f < 3 GHz
				f = 3.5 GHz	-	32	-	dB
	PEMlxxxx/RE	$R_{S(ch)} = 100\ \Omega$						
								800 MHz < f < 3 GHz
				f = 3 GHz	-	33	-	dB
	PEMlxxxx/WE	$R_{S(ch)} = 200\ \Omega$						
								800 MHz < f < 3 GHz
				f = 2.2 GHz	-	34	-	dB
	$\alpha_{ij}$	insertion loss	$C_{ch} = 19\text{ pF}$					
								PEMlxxxx/CG
				800 MHz < f < 3 GHz	9	-	-	dB
				f = 4 GHz	-	32	-	dB
PEMlxxxx/HG		$R_{S(ch)} = 45\ \Omega$						
								800 MHz < f < 3 GHz
				f = 3.2 GHz	-	33	-	dB
PEMlxxxx/LG		$R_{S(ch)} = 65\ \Omega$						
								800 MHz < f < 3 GHz
				f = 2.8 GHz	-	33.5	-	dB
PEMlxxxx/RG		$R_{S(ch)} = 100\ \Omega$						
								800 MHz < f < 3 GHz
				f = 2.5 GHz	-	34	-	dB
PEMlxxxx/WG		$R_{S(ch)} = 200\ \Omega$						
								800 MHz < f < 3 GHz
				f = 1.9 GHz	-	35.5	-	dB

**Table 7. Frequency characteristics ...continued** $T_{amb} = 25\text{ }^{\circ}\text{C}$ ; unless otherwise specified;  $R_{source} = 50\ \Omega$ ;  $R_L = 50\ \Omega$ .

Symbol	Parameter	Conditions	Min	Typ	Max	Unit	
$\alpha_{il}$	insertion loss	$C_{ch} = 23\text{ pF}$					
		PEMIXxxx/CK	$R_{S(ch)} = 20\ \Omega$				
	$800\text{ MHz} < f < 3\text{ GHz}$		10	-	-	dB	
	$f = 3.6\text{ GHz}$		-	33	-	dB	
	PEMIXxxx/HK	$R_{S(ch)} = 45\ \Omega$					
		$800\text{ MHz} < f < 3\text{ GHz}$	13	-	-	dB	
		$f = 2.8\text{ GHz}$	-	34	-	dB	
	PEMIXxxx/LK	$R_{S(ch)} = 65\ \Omega$					
		$800\text{ MHz} < f < 3\text{ GHz}$	15	-	-	dB	
		$f = 2.5\text{ GHz}$	-	35	-	dB	
	PEMIXxxx/RK	$R_{S(ch)} = 100\ \Omega$					
		$800\text{ MHz} < f < 3\text{ GHz}$	18	-	-	dB	
		$f = 2.1\text{ GHz}$	-	36	-	dB	
	PEMIXxxx/WK	$R_{S(ch)} = 200\ \Omega$					
		$800\text{ MHz} < f < 3\text{ GHz}$	24	-	-	dB	
		$f = 1.6\text{ GHz}$	-	37	-	dB	
	$\alpha_{il}$	insertion loss	$C_{ch} = 28\text{ pF}$				
			PEMIXxxx/CM	$R_{S(ch)} = 20\ \Omega$			
$800\text{ MHz} < f < 3\text{ GHz}$		12		-	-	dB	
$f = 3.2\text{ GHz}$		-		34	-	dB	
PEMIXxxx/HM		$R_{S(ch)} = 45\ \Omega$					
		$800\text{ MHz} < f < 3\text{ GHz}$	15	-	-	dB	
		$f = 2.5\text{ GHz}$	-	35	-	dB	
PEMIXxxx/LM		$R_{S(ch)} = 65\ \Omega$					
		$800\text{ MHz} < f < 3\text{ GHz}$	17	-	-	dB	
		$f = 2.1\text{ GHz}$	-	36	-	dB	
PEMIXxxx/RM		$R_{S(ch)} = 100\ \Omega$					
		$800\text{ MHz} < f < 3\text{ GHz}$	21	-	-	dB	
		$f = 1.8\text{ GHz}$	-	37	-	dB	
PEMIXxxx/WM		$R_{S(ch)} = 200\ \Omega$					
		$800\text{ MHz} < f < 3\text{ GHz}$	27	-	-	dB	
		$f = 1.4\text{ GHz}$	-	38	-	dB	



Table 7. Frequency characteristics ...continued

 $T_{amb} = 25\text{ }^{\circ}\text{C}$ ; unless otherwise specified;  $R_{source} = 50\ \Omega$ ;  $R_L = 50\ \Omega$ .

Symbol	Parameter	Conditions	Min	Typ	Max	Unit		
$\alpha_{il}$	insertion loss	$C_{ch} = 32\text{ pF}$						
							PEMlxxxx/CP	$R_{S(ch)} = 20\ \Omega$
				800 MHz < f < 3 GHz	13	-	-	dB
				f = 2.9 GHz	-	36	-	dB
		PEMlxxxx/HP	$R_{S(ch)} = 45\ \Omega$					
				800 MHz < f < 3 GHz	17	-	-	dB
				f = 2.2 GHz	-	36	-	dB
		PEMlxxxx/LP	$R_{S(ch)} = 65\ \Omega$					
				800 MHz < f < 3 GHz	19	-	-	dB
				f = 1.9 GHz	-	37	-	dB
		PEMlxxxx/RP	$R_{S(ch)} = 100\ \Omega$					
				800 MHz < f < 3 GHz	23	-	-	dB
				f = 1.6 GHz	-	38	-	dB
		PEMlxxxx/WP	$R_{S(ch)} = 200\ \Omega$					
				800 MHz < f < 3 GHz	30	-	-	dB
				f = 1.2 GHz	-	39	-	dB
	$\alpha_{il}$	insertion loss	$C_{ch} = 36\text{ pF}$					
								PEMlxxxx/CR
				800 MHz < f < 3 GHz	14	-	-	dB
				f = 2.6 GHz	-	36	-	dB
		PEMlxxxx/HR	$R_{S(ch)} = 45\ \Omega$					
				800 MHz < f < 3 GHz	18	-	-	dB
				f = 2.0 GHz	-	37	-	dB
		PEMlxxxx/LR	$R_{S(ch)} = 65\ \Omega$					
				800 MHz < f < 3 GHz	21	-	-	dB
				f = 1.8 GHz	-	38	-	dB
		PEMlxxxx/RR	$R_{S(ch)} = 100\ \Omega$					
				800 MHz < f < 3 GHz	25	-	-	dB
				f = 1.6 GHz	-	39	-	dB
		PEMlxxxx/WR	$R_{S(ch)} = 200\ \Omega$					
				800 MHz < f < 3 GHz	32	-	-	dB
				f = 1.2 GHz	-	40	-	dB

**Table 7. Frequency characteristics ...continued**  
 $T_{amb} = 25\text{ }^{\circ}\text{C}$ ; unless otherwise specified;  $R_{source} = 50\ \Omega$ ;  $R_L = 50\ \Omega$ .

Symbol	Parameter	Conditions	Min	Typ	Max	Unit			
$\alpha_{ij}$	insertion loss	$C_{ch} = 40\ \text{pF}$	$R_{S(ch)} = 20\ \Omega$	800 MHz < f < 3 GHz	16	-	-	dB	
					f = 2.5 GHz	-	36	-	dB
		PEMlxxxx/CT	$R_{S(ch)} = 45\ \Omega$	800 MHz < f < 3 GHz	20	-	-	dB	
					f = 1.9 GHz	-	38	-	dB
		PEMlxxxx/HT	$R_{S(ch)} = 65\ \Omega$	800 MHz < f < 3 GHz	23	-	-	dB	
					f = 1.6 GHz	-	39	-	dB
		PEMlxxxx/LT	$R_{S(ch)} = 100\ \Omega$	800 MHz < f < 3 GHz	27	-	-	dB	
					f = 1.4 GHz	-	40	-	dB
		PEMlxxxx/RT	$R_{S(ch)} = 200\ \Omega$	800 MHz < f < 3 GHz	32	-	-	dB	
					f = 1.0 GHz	-	41	-	dB

## 6. Application information

### 6.1 Use cases

The selection of one of the filter devices has to be performed in dependence of the maximum clock frequency, the driver strength, the capacitive load of the sink and the maximum applicable rise and fall times.

### 6.2 LCD interfaces, medium-speed interfaces

For digital interfaces such as Liquid Crystal Display (LCD) interfaces running at clock speeds between 10 MHz and 25 MHz or more, the devices can be used in dependence of the sink load, the clock speed, the driver strength and the rise and fall time requirements. The minimum EMI filter requirements may be an important factor, too.

### 6.3 Keypad, low-speed interfaces

Especially for lower-speed interfaces such as keypads, low-speed serial interfaces and low-speed control signals, the devices offer a very robust ESD protection and strong suppression of unwanted frequencies (EMI filtering). Due to their small size the devices can easily be spread on a Printed-Circuit Board (PCB) in order to move the ESD and EMI protection close to the part of the design which shall be protected.

## 6.4 Insertion loss

The devices are designed as EMI/RFI filters for multichannel interfaces.

All measurements were performed in a typical 50 Ω NetWork Analyzer (NWA) setup as shown in [Figure 1](#). The insertion loss was measured with a test Printed-Circuit Board (PCB) utilizing laser-drilled micro-via holes which connect the PCB ground plane to the devices ground pins.

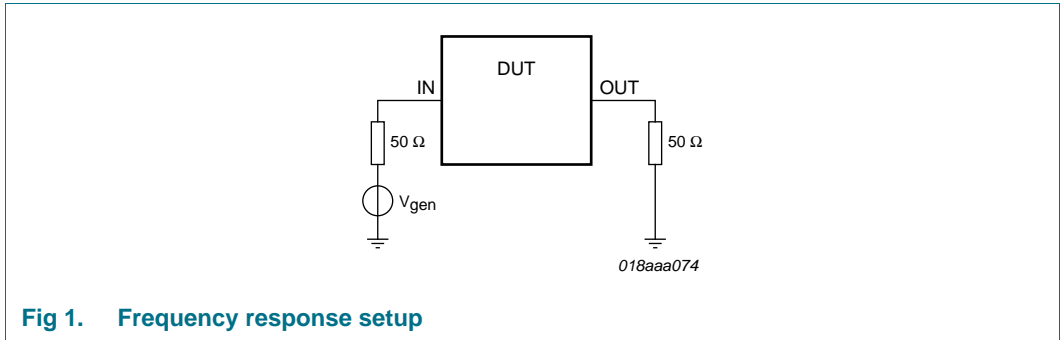

Fig 1. Frequency response setup

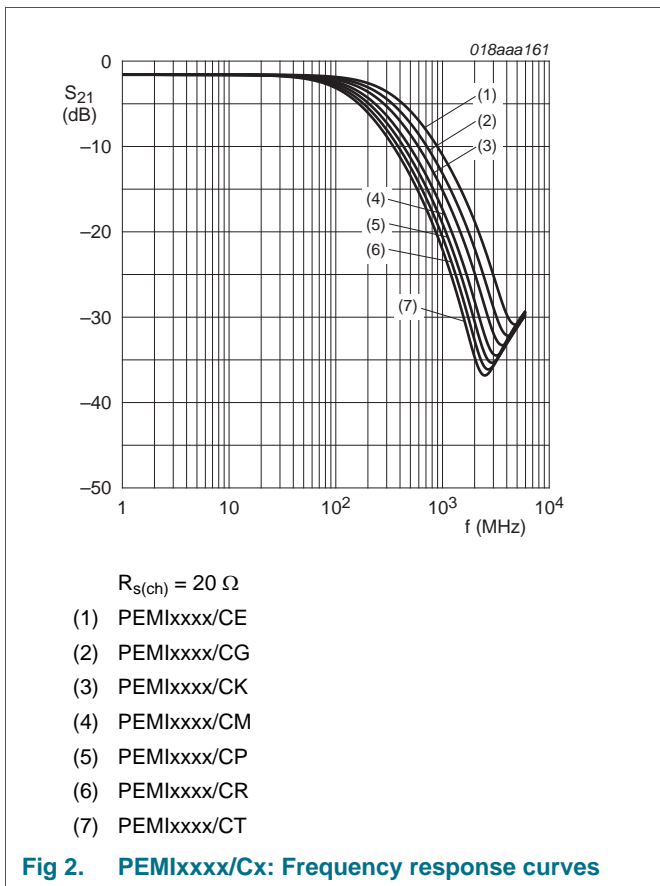

Fig 2. PEMIxxx/Cx: Frequency response curves

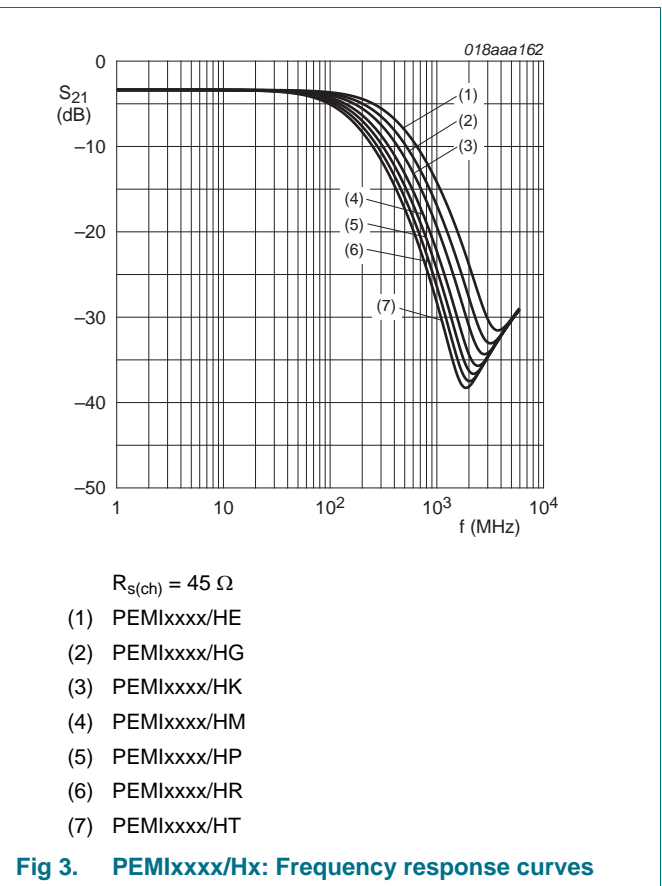
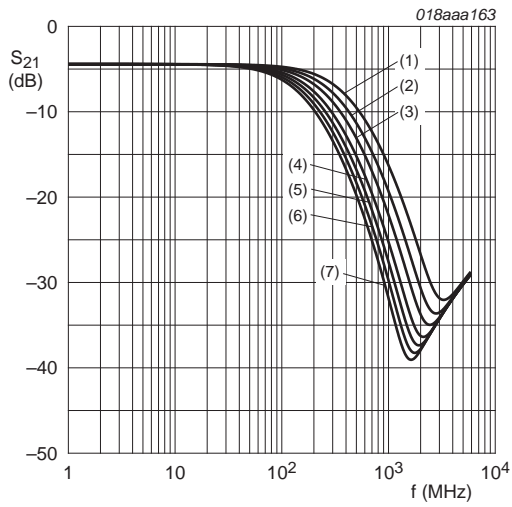
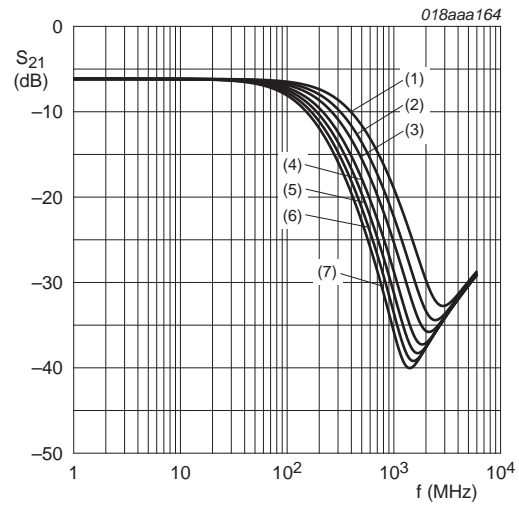

Fig 3. PEMIxxx/Hx: Frequency response curves



- $R_{s(ch)} = 65 \Omega$
- (1) PEMIxxx/LE
  - (2) PEMIxxx/LG
  - (3) PEMIxxx/LK
  - (4) PEMIxxx/LM
  - (5) PEMIxxx/LP
  - (6) PEMIxxx/LR
  - (7) PEMIxxx/LT

**Fig 4. PEMIxxx/Lx: Frequency response curves**



- $R_{s(ch)} = 100 \Omega$
- (1) PEMIxxx/RE
  - (2) PEMIxxx/RG
  - (3) PEMIxxx/RK
  - (4) PEMIxxx/RM
  - (5) PEMIxxx/RP
  - (6) PEMIxxx/RR
  - (7) PEMIxxx/RT

**Fig 5. PEMIxxx/Rx: Frequency response curves**

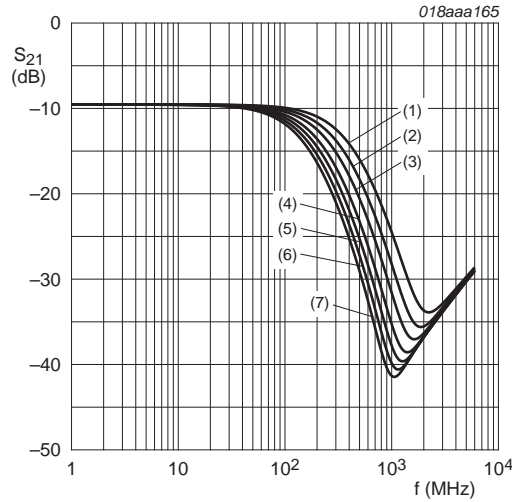

- $R_{s(ch)} = 200 \Omega$
- (1) PEMIxxx/WE
  - (2) PEMIxxx/WG
  - (3) PEMIxxx/WK
  - (4) PEMIxxx/WM
  - (5) PEMIxxx/WP
  - (6) PEMIxxx/WR
  - (7) PEMIxxx/WT

**Fig 6. PEMIxxx/Wx: Frequency response curves**

All important values of the RF behavior such as relative  $-3\text{dB}$  frequency, insertion loss at 800 MHz and above and also the DC attenuation in an NWA environment can be derived from the insertion loss response curves depicted in [Figure 2](#) to [6](#).

Note: insertion loss at low frequencies (1 MHz) is nearly independent from the channel capacitance values available within the PEMI family.

### 6.4.1 Relative $-3\text{dB}$ frequency ( $\pi$ -filter structure)

**Table 8. Relative  $-3\text{dB}$  frequency (MHz) per RC combination; typical values**

$T_{amb} = 25 \text{ }^\circ\text{C}$ ; unless otherwise specified.

PEMIxxx/	xE	xG	xK	xM	xP	xR	xT	
<b>C<sub>ch</sub> (pF)</b>	<b>15</b>	<b>19</b>	<b>23</b>	<b>28</b>	<b>32</b>	<b>36</b>	<b>40</b>	
PEMIxxx/	R <sub>s(ch)</sub>							
Cx	20	397 MHz	317 MHz	264 MHz	218 MHz	194 MHz	170 MHz	153 MHz
Hx	45	376 MHz	300 MHz	249 MHz	206 MHz	185 MHz	161 MHz	145 MHz
Lx	65	361 MHz	288 MHz	239 MHz	197 MHz	176 MHz	155 MHz	139 MHz
Rx	100	343 MHz	272 MHz	227 MHz	187 MHz	166 MHz	145 MHz	131 MHz
Wx	200	311 MHz	247 MHz	205 MHz	169 MHz	150 MHz	132 MHz	119 MHz

## 6.4.2 Insertion loss (dB) at 800 MHz ( $\pi$ -filter structure)

**Table 9.** Insertion loss (dB) at 800 MHz per RC combination; typical values

$T_{amb} = 25\text{ }^{\circ}\text{C}$ ; unless otherwise specified.

PEMIxxx/		xE	xG	xK	xM	xP	xR	xT
C <sub>ch</sub> (pF)		15	19	23	28	32	36	40
PEMIxxx/	R <sub>s(ch)</sub>							
Cx	20	-9 dB	-11 dB	-13 dB	-15 dB	-16 dB	-18 dB	-19 dB
Hx	45	-12 dB	-14 dB	-17 dB	-19 dB	-21 dB	-23 dB	-25 dB
Lx	65	-14 dB	-17 dB	-19 dB	-22 dB	-25 dB	-27 dB	-29 dB
Rx	100	-17 dB	-20 dB	-23 dB	-26 dB	-29 dB	-32 dB	-35 dB
Wx	200	-22 dB	-26 dB	-29 dB	-34 dB	-36 dB	-39 dB	-41 dB

## 6.4.3 Insertion loss (dB) at frequencies lower than 1 MHz ( $\pi$ -filter structure)

**Table 10.** Insertion loss (dB) at  $\leq 1$  MHz per RC combination; typical values

$T_{amb} = 25\text{ }^{\circ}\text{C}$ ; unless otherwise specified.

PEMIxxx/		xE	xG	xK	xM	xP	xR	xT
C <sub>ch</sub> (pF)		15	19	23	28	32	36	40
PEMIxxx/	R <sub>s(ch)</sub>							
Cx	20	-1.6 dB	-1.6 dB	-1.6 dB	-1.6 dB	-1.6 dB	-1.6 dB	-1.6 dB
Hx	45	-3.2 dB	-3.2 dB	-3.2 dB	-3.2 dB	-3.2 dB	-3.2 dB	-3.2 dB
Lx	65	-4.3 dB	-4.3 dB	-4.3 dB	-4.3 dB	-4.3 dB	-4.3 dB	-4.3 dB
Rx	100	-6.0 dB	-6.0 dB	-6.0 dB	-6.0 dB	-6.0 dB	-6.0 dB	-6.0 dB
Wx	200	-9.5 dB	-9.5 dB	-9.5 dB	-9.5 dB	-9.5 dB	-9.5 dB	-9.5 dB

## 7. Marking

**Table 11.** Marking codes

Type number	Marking code	Type number	Marking code	Type number	Marking code	Type number	Marking code
PEMI1QFN/CE	CE	PEMI2QFN/LP	LP	PEMI4QFN/CE	CE	PEMI6QFN/LP	LP
PEMI1QFN/CG	CG	PEMI2QFN/LR	LR	PEMI4QFN/CG	CG	PEMI6QFN/LR	LR
PEMI1QFN/CK	CK	PEMI2QFN/LT	LT	PEMI4QFN/CK	CK	PEMI6QFN/LT	LT
PEMI1QFN/CM	CM	PEMI2QFN/RE	RE	PEMI4QFN/CM	CM	PEMI6QFN/RE	RE
PEMI1QFN/CP	CP	PEMI2QFN/RG	RG	PEMI4QFN/CP	CP	PEMI6QFN/RG	RG
PEMI1QFN/CR	CR	PEMI2QFN/RK	RK	PEMI4QFN/CR	CR	PEMI6QFN/RK	RK
PEMI1QFN/CT	CT	PEMI2QFN/RM	RM	PEMI4QFN/CT	CT	PEMI6QFN/RM	RM
PEMI1QFN/HE	HE	PEMI2QFN/RP	RP	PEMI4QFN/HE	HE	PEMI6QFN/RP	RP
PEMI1QFN/HG	HG	PEMI2QFN/RR	RR	PEMI4QFN/HG	HG	PEMI6QFN/RR	RR
PEMI1QFN/HK	HK	PEMI2QFN/RT	RT	PEMI4QFN/HK	HK	PEMI6QFN/RT	RT
PEMI1QFN/HM	HM	PEMI2QFN/WE	WE	PEMI4QFN/HM	HM	PEMI6QFN/WE	WE
PEMI1QFN/HP	HP	PEMI2QFN/WG	WG	PEMI4QFN/HP	HP	PEMI6QFN/WG	WG
PEMI1QFN/HR	HR	PEMI2QFN/WK	WK	PEMI4QFN/HR	HR	PEMI6QFN/WK	WK
PEMI1QFN/HT	HT	PEMI2QFN/WM	WM	PEMI4QFN/HT	HT	PEMI6QFN/WM	WM

Table 11. Marking codes ...continued

Type number	Marking code	Type number	Marking code	Type number	Marking code	Type number	Marking code
PEMI1QFN/LE	LE	PEMI2QFN/WP	WP	PEMI4QFN/LE	LE	PEMI6QFN/WP	WP
PEMI1QFN/LG	LG	PEMI2QFN/WR	WR	PEMI4QFN/LG	LG	PEMI6QFN/WR	WR
PEMI1QFN/LK	LK	PEMI2QFN/WT	WT	PEMI4QFN/LK	LK	PEMI6QFN/WT	WT
PEMI1QFN/LM	LM	PEMI2STD/CE	CE	PEMI4QFN/LM	LM	PEMI8QFN/CE	CE
PEMI1QFN/LP	LP	PEMI2STD/CG	CG	PEMI4QFN/LP	LP	PEMI8QFN/CG	CG
PEMI1QFN/LR	LR	PEMI2STD/CK	CK	PEMI4QFN/LR	LR	PEMI8QFN/CK	CK
PEMI1QFN/LT	LT	PEMI2STD/CM	CM	PEMI4QFN/LT	LT	PEMI8QFN/CM	CM
PEMI1QFN/RE	RE	PEMI2STD/CP	CP	PEMI4QFN/RE	RE	PEMI8QFN/CP	CP
PEMI1QFN/RG	RG	PEMI2STD/CR	CR	PEMI4QFN/RG	RG	PEMI8QFN/CR	CR
PEMI1QFN/RK	RK	PEMI2STD/CT	CT	PEMI4QFN/RK	RK	PEMI8QFN/CT	CT
PEMI1QFN/RM	RM	PEMI2STD/HE	HE	PEMI4QFN/RM	RM	PEMI8QFN/HE	HE
PEMI1QFN/RP	RP	PEMI2STD/HG	HG	PEMI4QFN/RP	RP	PEMI8QFN/HG	HG
PEMI1QFN/RR	RR	PEMI2STD/HK	HK	PEMI4QFN/RR	RR	PEMI8QFN/HK	HK
PEMI1QFN/RT	RT	PEMI2STD/HM	HM	PEMI4QFN/RT	RT	PEMI8QFN/HM	HM
PEMI1QFN/WE	WE	PEMI2STD/HP	HP	PEMI4QFN/WE	WE	PEMI8QFN/HP	HP
PEMI1QFN/WG	WG	PEMI2STD/HR	HR	PEMI4QFN/WG	WG	PEMI8QFN/HR	HR
PEMI1QFN/WK	WK	PEMI2STD/HT	HT	PEMI4QFN/WK	WK	PEMI8QFN/HT	HT
PEMI1QFN/WM	WM	PEMI2STD/LE	LE	PEMI4QFN/WM	WM	PEMI8QFN/LE	LE
PEMI1QFN/WP	WP	PEMI2STD/LG	LG	PEMI4QFN/WP	WP	PEMI8QFN/LG	LG
PEMI1QFN/WR	WR	PEMI2STD/LK	LK	PEMI4QFN/WR	WR	PEMI8QFN/LK	LK
PEMI1QFN/WT	WT	PEMI2STD/LM	LM	PEMI4QFN/WT	WT	PEMI8QFN/LM	LM
PEMI2QFN/CE	CE	PEMI2STD/LP	LP	PEMI6QFN/CE	CE	PEMI8QFN/LP	LP
PEMI2QFN/CG	CG	PEMI2STD/LR	LR	PEMI6QFN/CG	CG	PEMI8QFN/LR	LR
PEMI2QFN/CK	CK	PEMI2STD/LT	LT	PEMI6QFN/CK	CK	PEMI8QFN/LT	LT
PEMI2QFN/CM	CM	PEMI2STD/RE	RE	PEMI6QFN/CM	CM	PEMI8QFN/RE	RE
PEMI2QFN/CP	CP	PEMI2STD/RG	RG	PEMI6QFN/CP	CP	PEMI8QFN/RG	RG
PEMI2QFN/CR	CR	PEMI2STD/RK	RK	PEMI6QFN/CR	CR	PEMI8QFN/RK	RK
PEMI2QFN/CT	CT	PEMI2STD/RM	RM	PEMI6QFN/CT	CT	PEMI8QFN/RM	RM
PEMI2QFN/HE	HE	PEMI2STD/RP	RP	PEMI6QFN/HE	HE	PEMI8QFN/RP	RP
PEMI2QFN/HG	HG	PEMI2STD/RR	RR	PEMI6QFN/HG	HG	PEMI8QFN/RR	RR
PEMI2QFN/HK	HK	PEMI2STD/RT	RT	PEMI6QFN/HK	HK	PEMI8QFN/RT	RT
PEMI2QFN/HM	HM	PEMI2STD/WE	WE	PEMI6QFN/HM	HM	PEMI8QFN/WE	WE
PEMI2QFN/HP	HP	PEMI2STD/WG	WG	PEMI6QFN/HP	HP	PEMI8QFN/WG	WG
PEMI2QFN/HR	HR	PEMI2STD/WK	WK	PEMI6QFN/HR	HR	PEMI8QFN/WK	WK
PEMI2QFN/HT	HT	PEMI2STD/WM	WM	PEMI6QFN/HT	HT	PEMI8QFN/WM	WM
PEMI2QFN/LE	LE	PEMI2STD/WP	WP	PEMI6QFN/LE	LE	PEMI8QFN/WP	WP
PEMI2QFN/LG	LG	PEMI2STD/WR	WR	PEMI6QFN/LG	LG	PEMI8QFN/WR	WR
PEMI2QFN/LK	LK	PEMI2STD/WT	WT	PEMI6QFN/LK	LK	PEMI8QFN/WT	WT
PEMI2QFN/LM	LM	-	-	PEMI6QFN/LM	LM	-	-

## 8. Package outline

Leadless ultra small plastic package; 3 solder lands; body 1.0 x 0.6 x 0.5 mm

SOT883

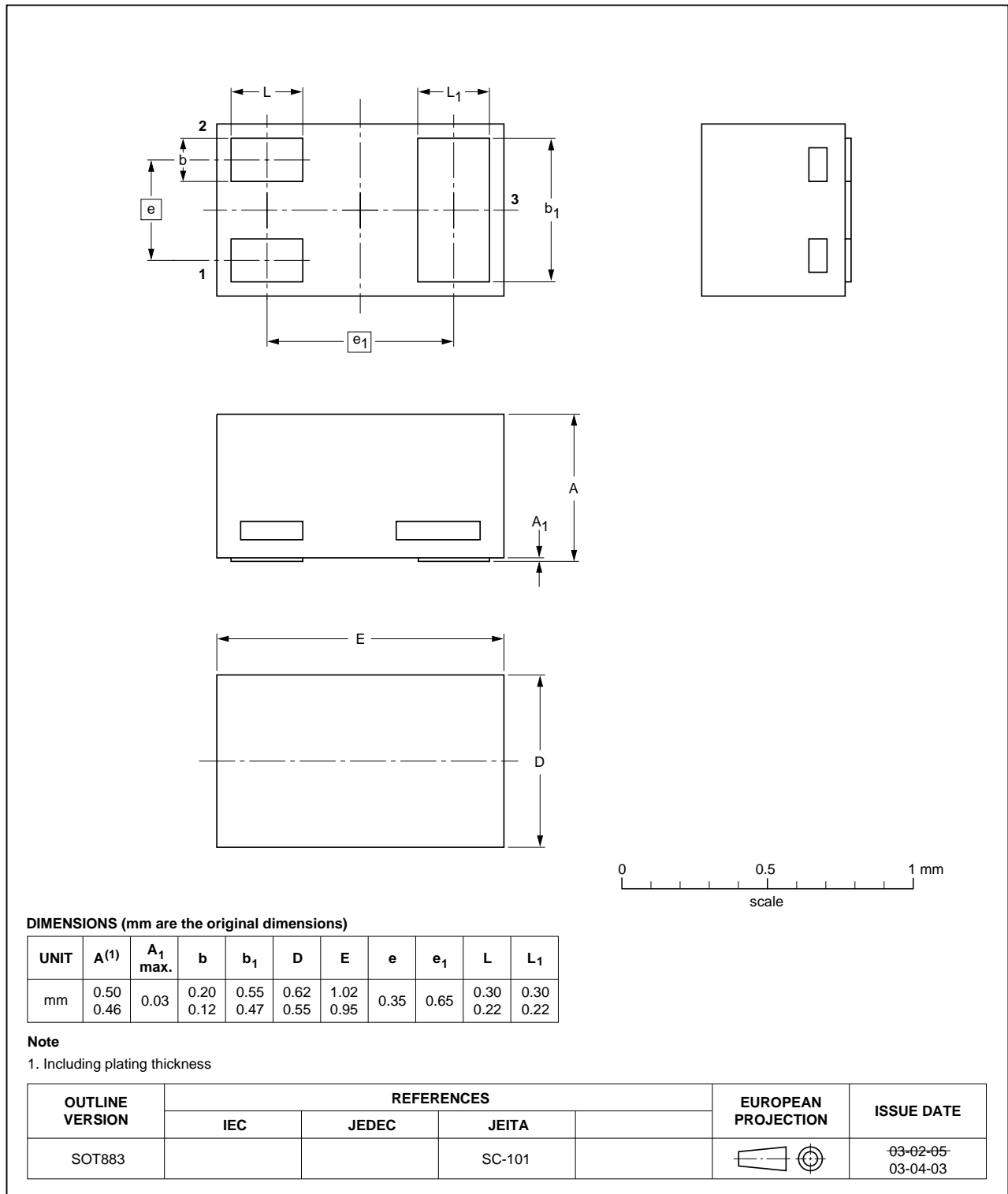

Fig 7. Package outline PEMI1QFN (SOT883/SC-101)



XSON6: plastic extremely thin small outline package; no leads; 6 terminals; body 1 x 1.45 x 0.5 mm

SOT886

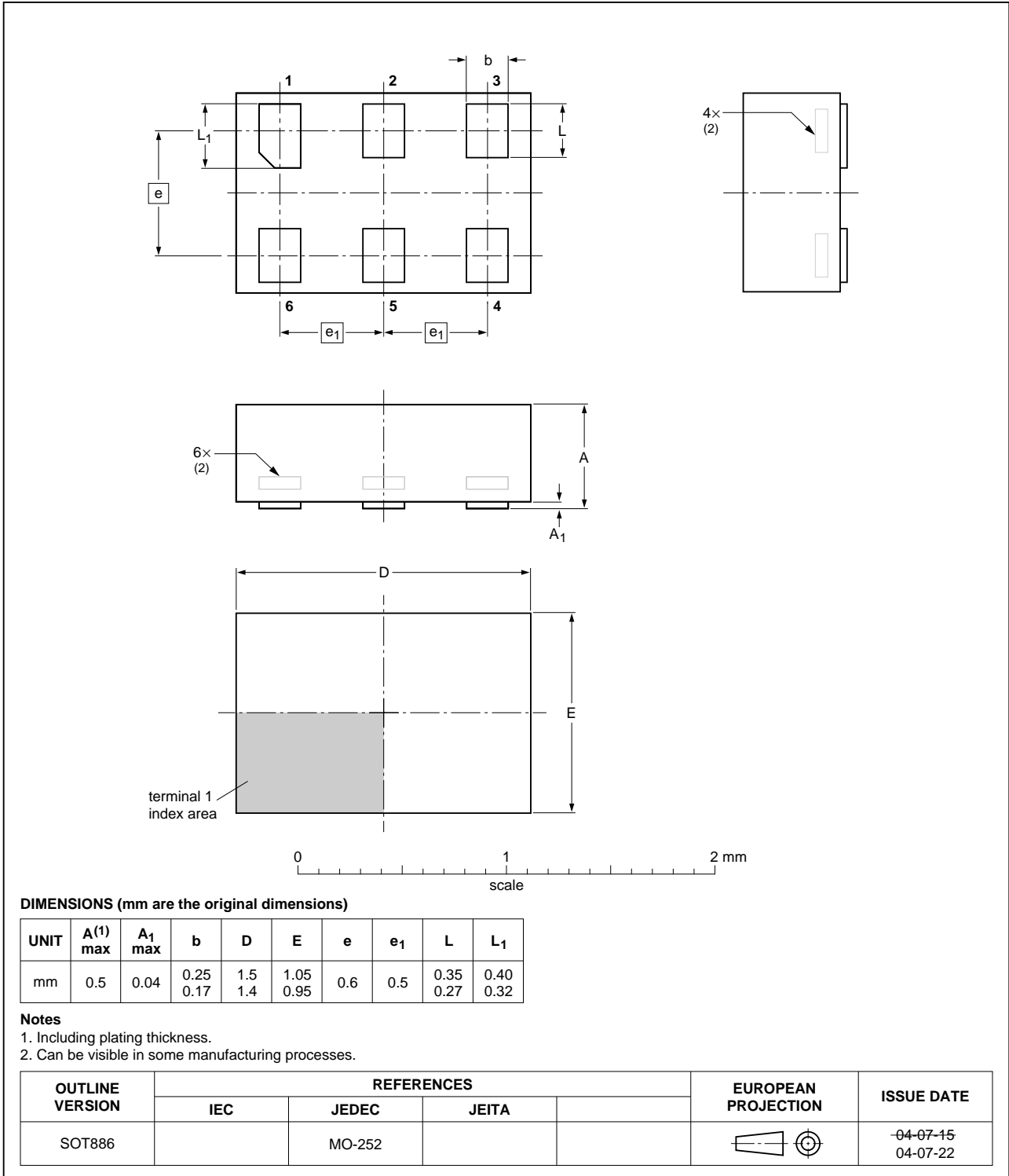

Fig 8. Package outline PEMI2QFN (SOT886/XSON6)

Plastic surface-mounted package; 5 leads

SOT665

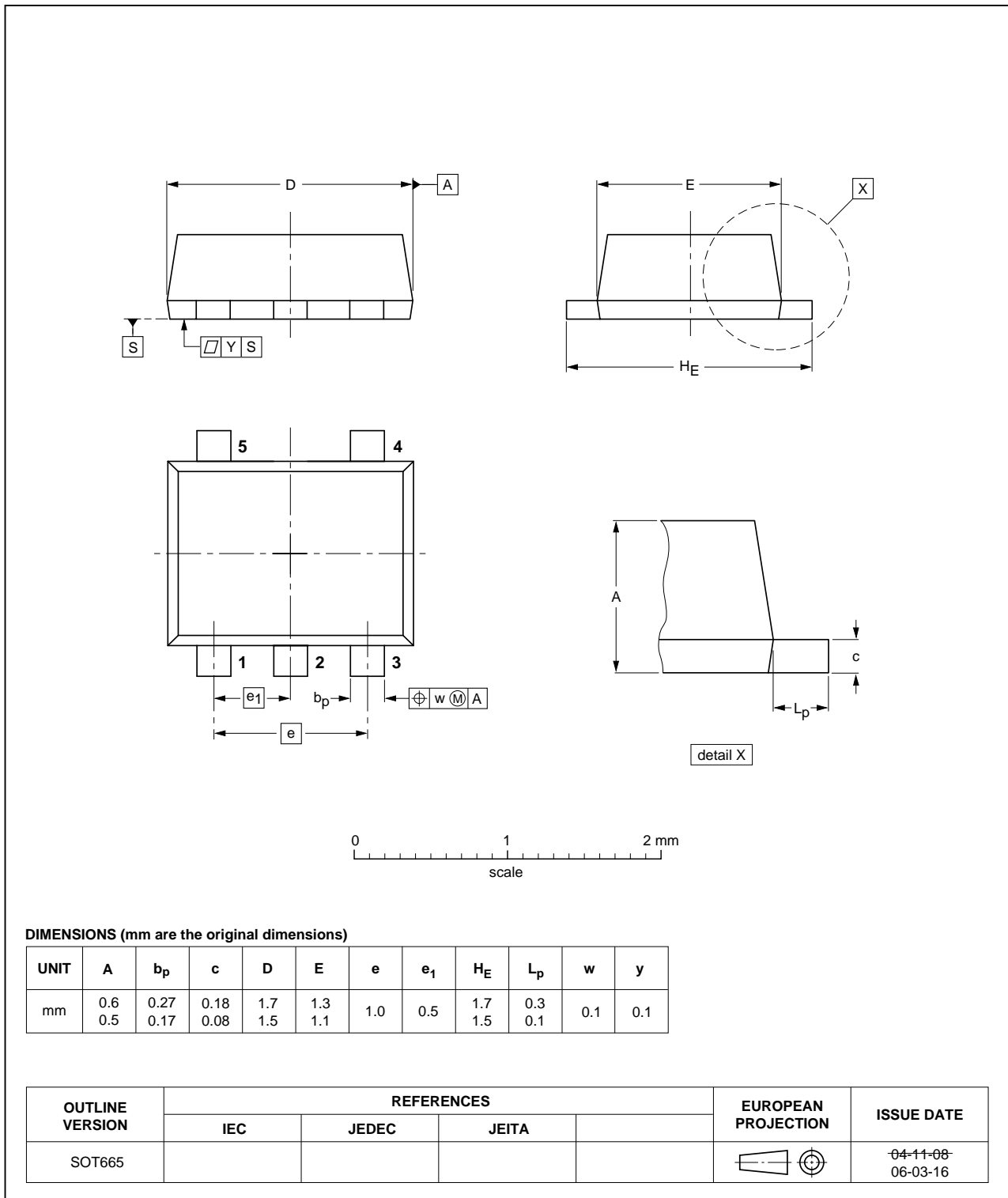

Fig 9. Package outline PEMI2STD (SOT665)

**HXSON8: plastic thermal enhanced extremely thin small outline package; no leads;**  
**8 terminals; body 1.2 x 1.7 x 0.5 mm**

SOT1157-1

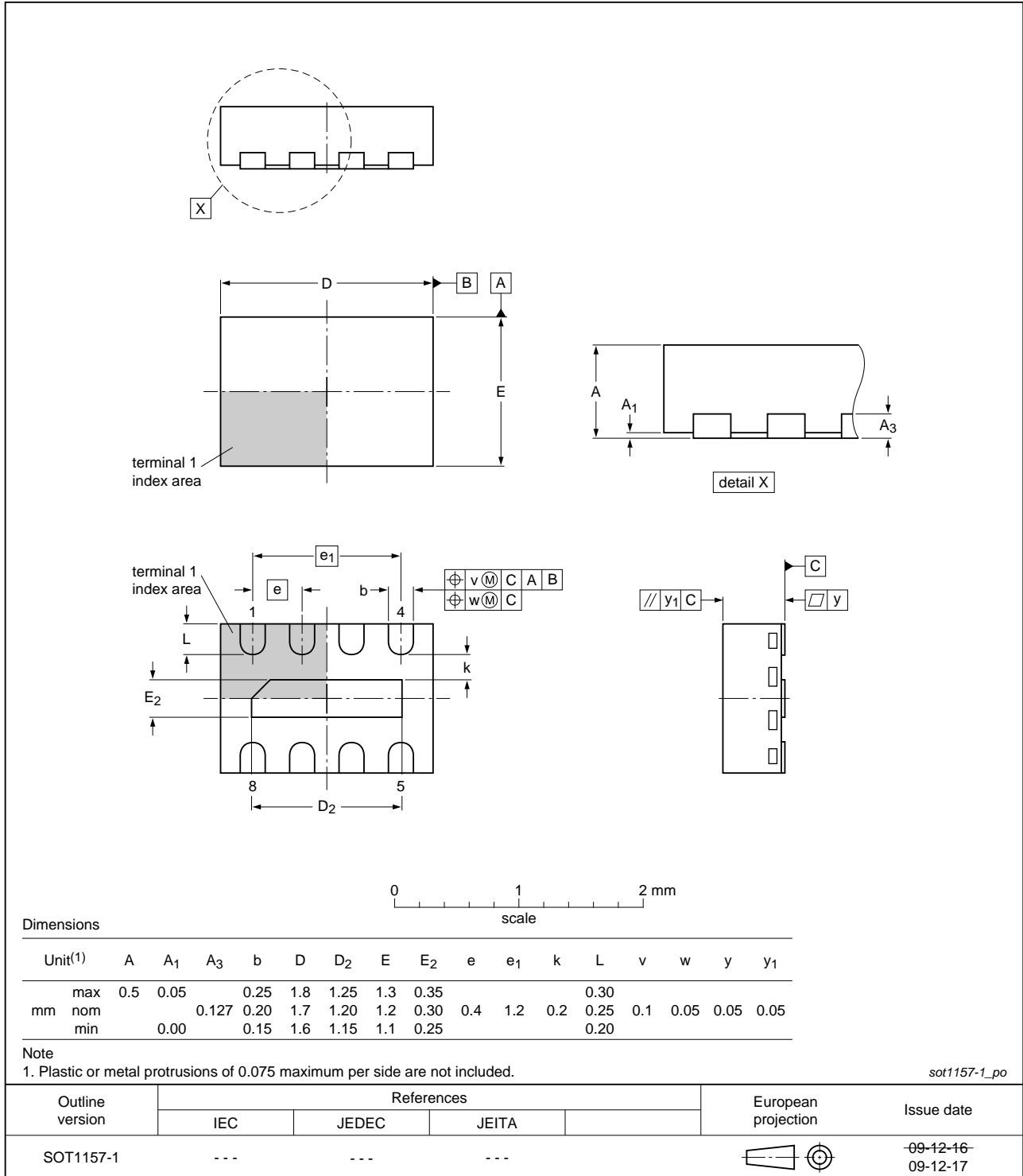
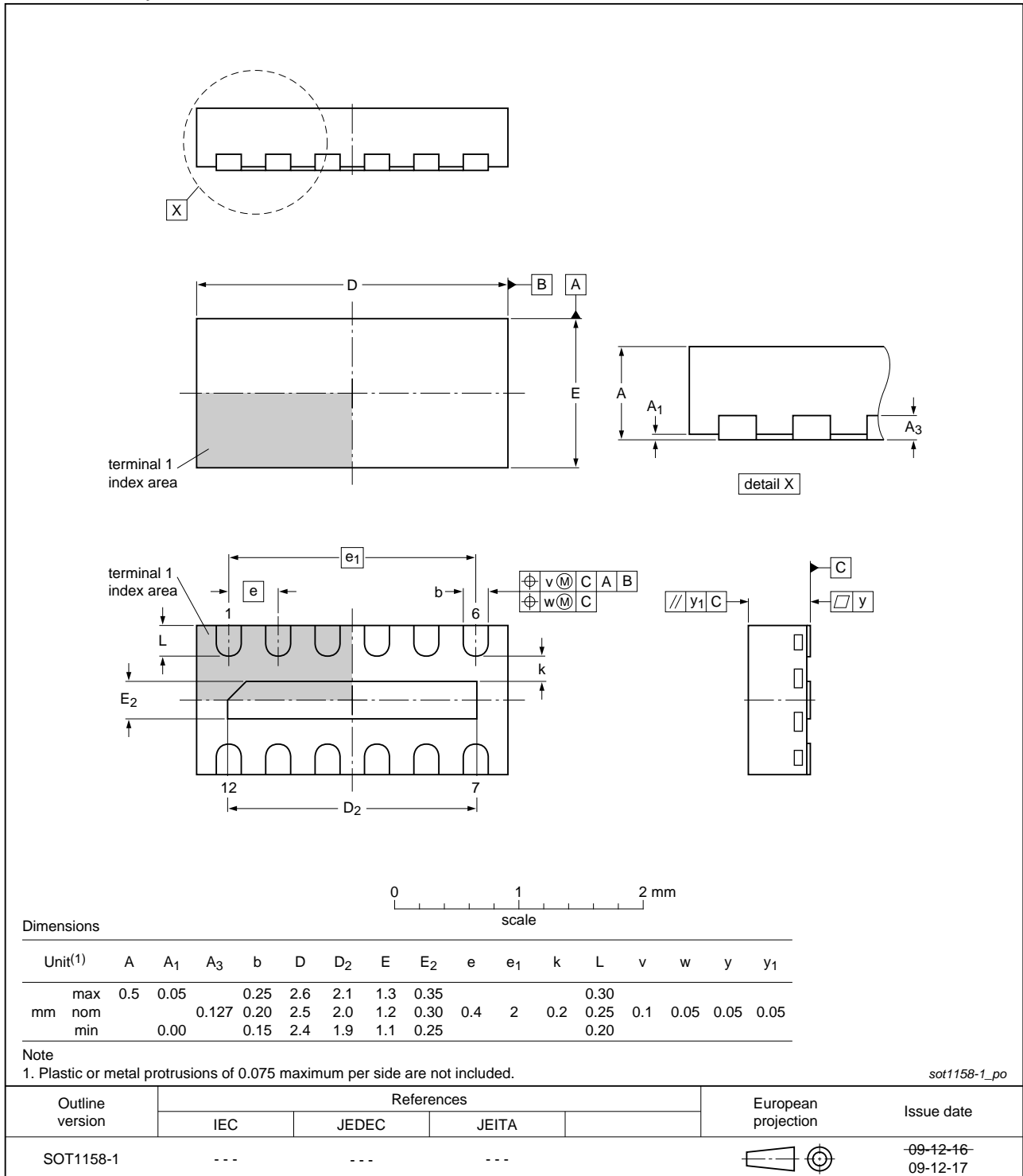

Fig 10. Package outline PEMI4QFN (SOT1157-1/HXSON8)

**HXSON12: plastic thermal enhanced extremely thin small outline package; no leads;**  
**12 terminals; body 1.2 x 2.5 x 0.5 mm**

SOT1158-1



**Fig 11. Package outline PEMI6QFN (SOT1158-1/HXSON12)**

**HXSON16: plastic thermal enhanced extremely thin small outline package; no leads;  
16 terminals; body 1.2 x 3.3 x 0.5 mm**

SOT1159-1

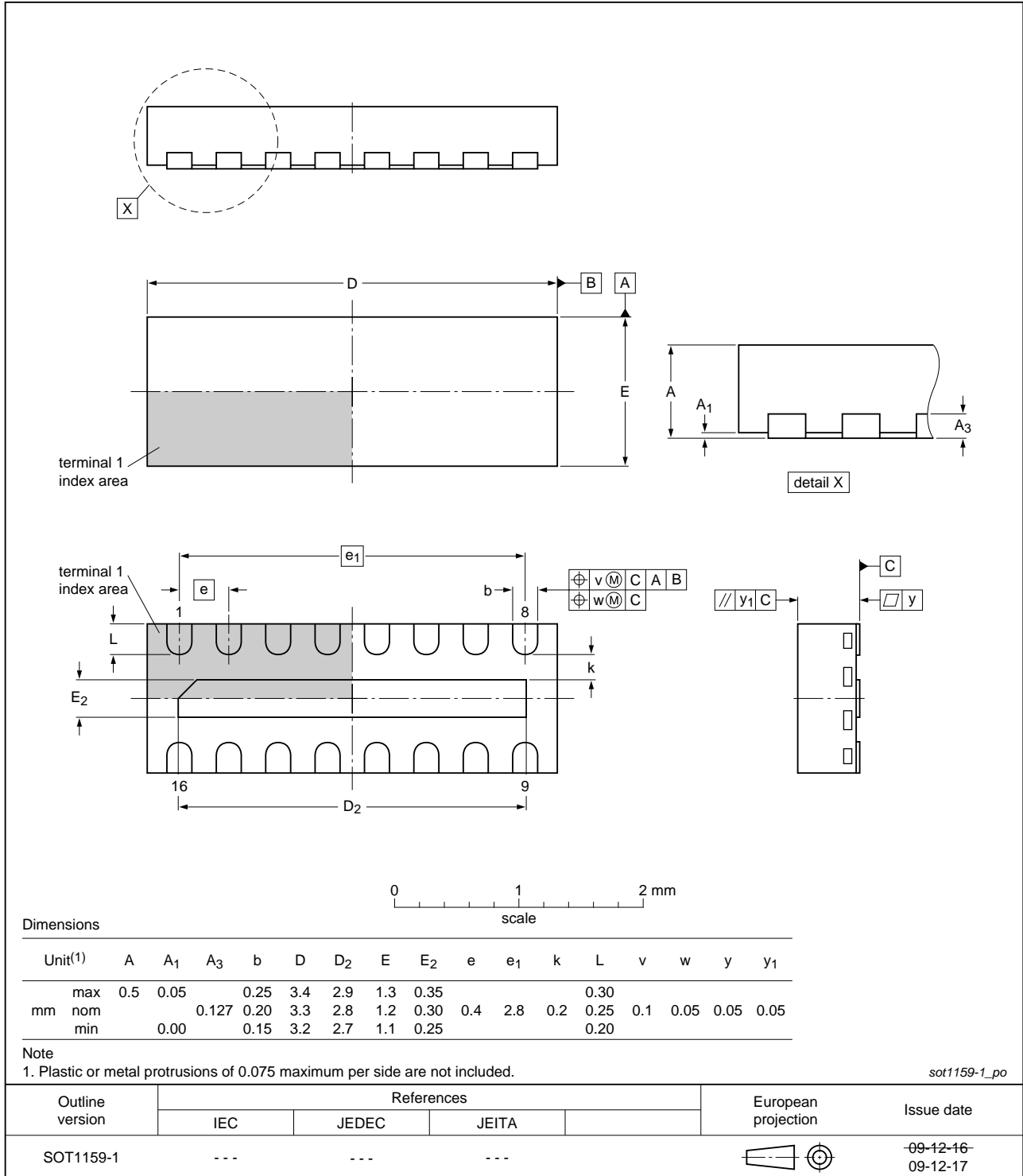
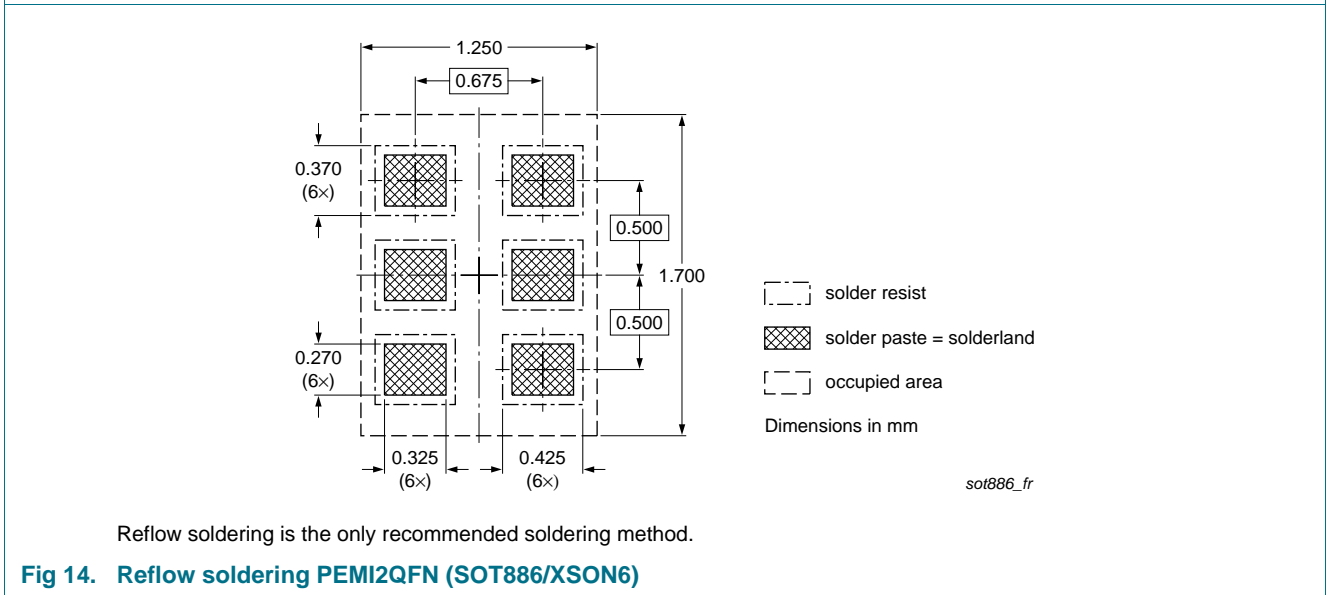
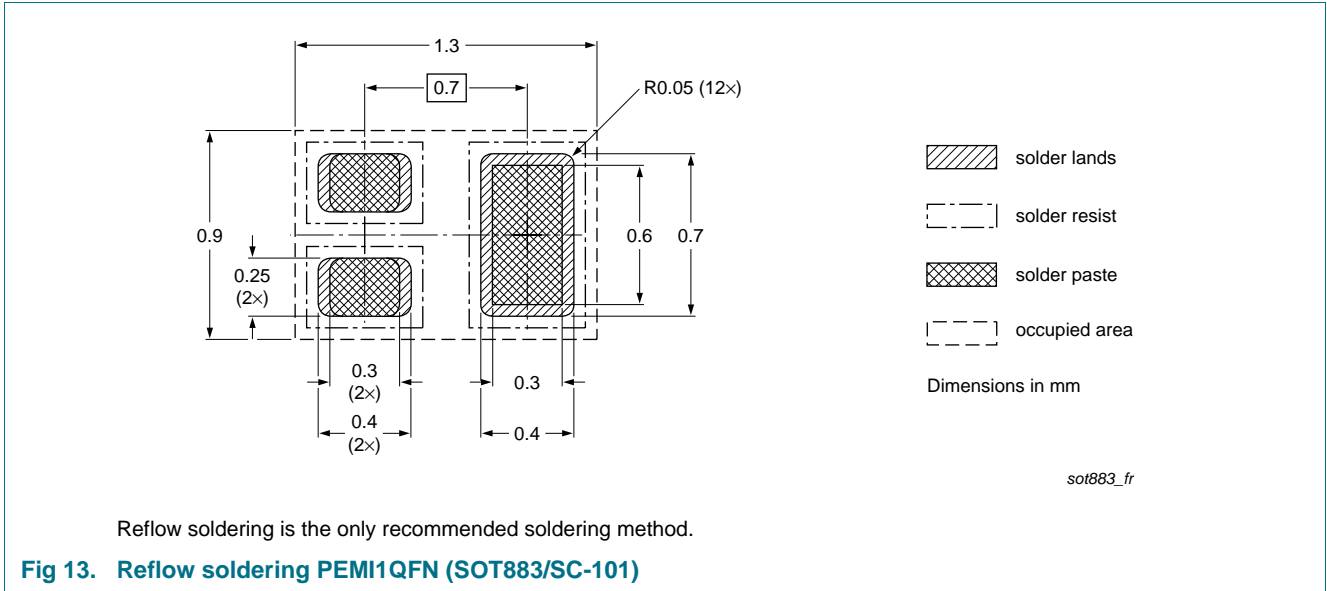
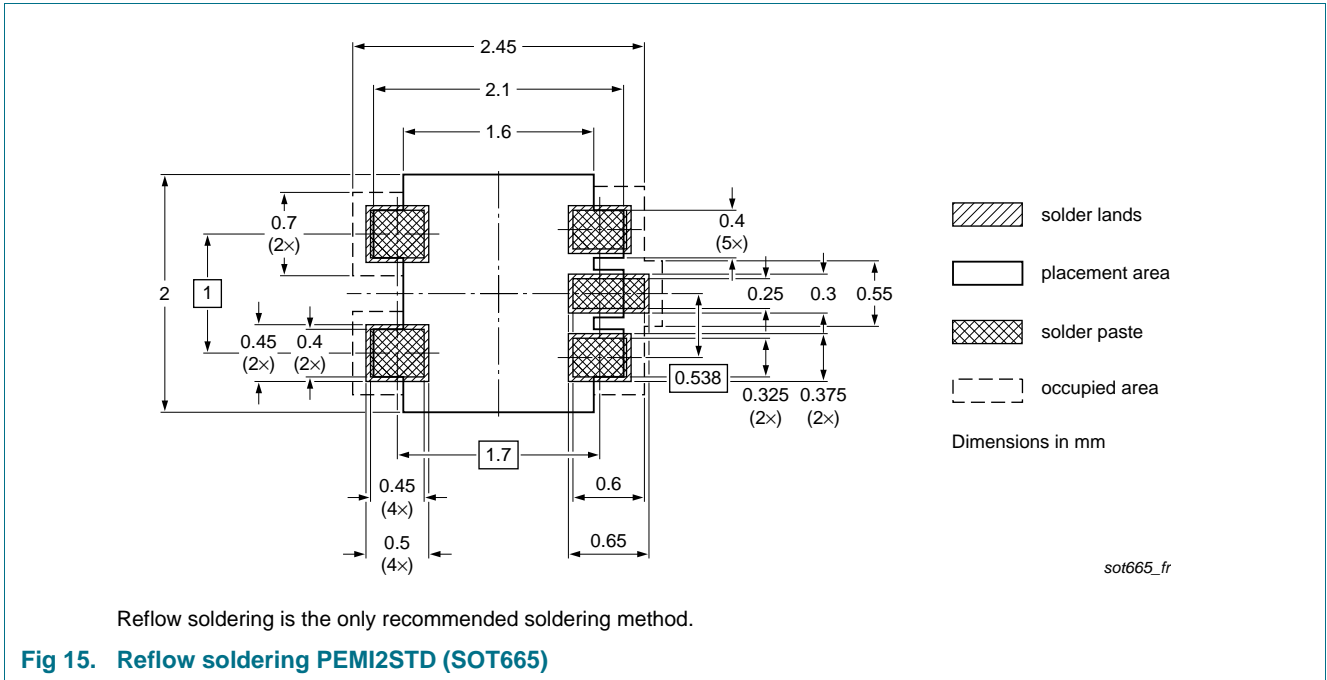

Fig 12. Package outline PEMI8QFN (SOT1159-1/HXSON16)

## 9. Soldering





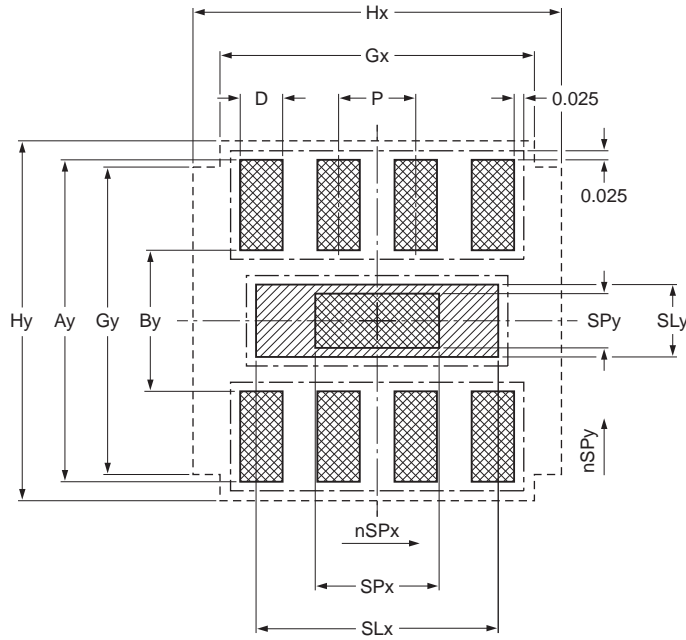

Footprint information for reflow soldering of HXSON8 package

SOT1157-1



Generic footprint pattern  
Refer to the package outline drawing for actual layout

-  solder land
-  solder paste deposit
-  solder land plus solder paste
- occupied area
- solder resist

DIMENSIONS in mm

P	Ay	By	D	SLx	SLy	SPx	SPy	Gx	Gy	Hx	Hy
0.40	1.75	0.75	0.22	1.25	0.35	0.6	0.2	1.65	1.45	1.95	2.0

Issue date ~~11-06-27~~  
11-07-06

sot1157-1\_fr

Reflow soldering is the only recommended soldering method.

Fig 16. Reflow soldering PEMI4QFN (SOT1157-1/HXSON8)



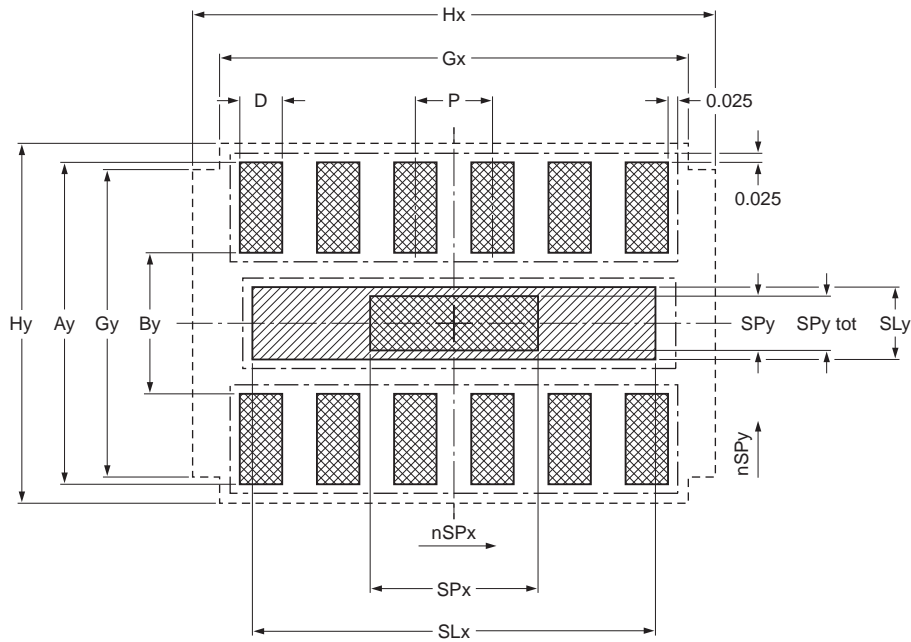

Footprint information for reflow soldering of HXSON12 package

SOT1158-1



Generic footprint pattern  
Refer to the package outline drawing for actual layout

-  solder land
-  solder paste deposit
-  solder land plus solder paste
- occupied area
- solder resist

DIMENSIONS in mm

P	Ay	By	D	SLx	SLy	SPx	SPy	Gx	Gy	Hx	Hy
0.40	1.75	0.75	0.22	2.1	0.35	0.9	0.2	2.45	1.45	2.75	2.0

Issue date ~~11-06-27~~  
11-07-06

sot1158-1\_fr

Reflow soldering is the only recommended soldering method.

**Fig 17. Reflow soldering PEMI6QFN (SOT1158-1/HXSON12)**

Footprint information for reflow soldering of HXSON16 package

SOT1159-1

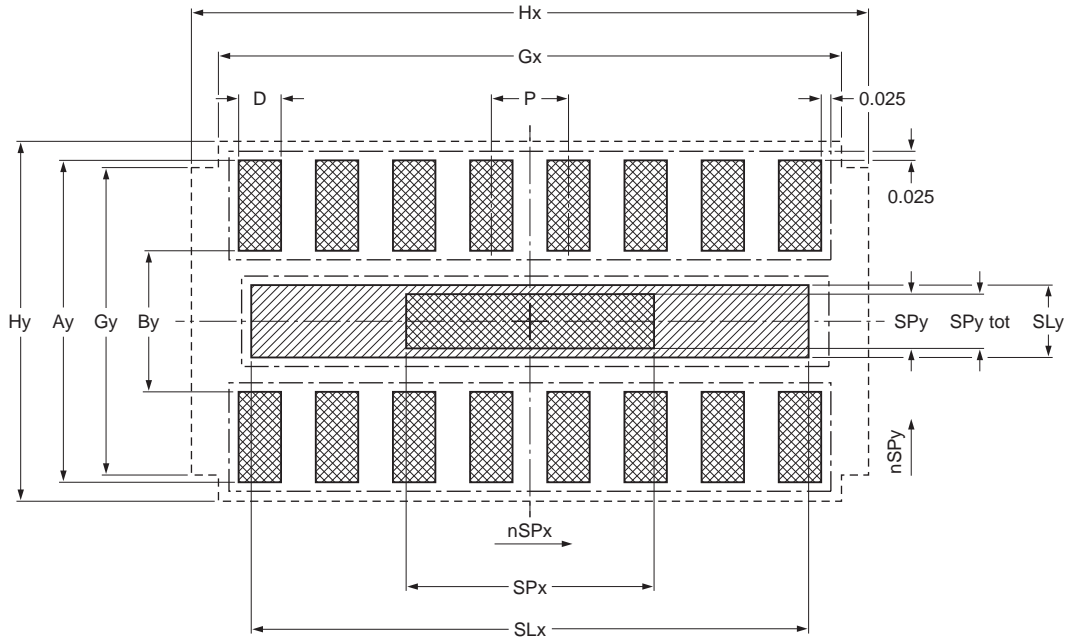

Generic footprint pattern  
Refer to the package outline drawing for actual layout

- solder land
- solder paste deposit
- solder land plus solder paste
- occupied area
- solder resist

DIMENSIONS in mm

P	Ay	By	D	SLx	SLy	SPx	SPy	Gx	Gy	Hx	Hy
0.40	2.15	0.75	0.21	2.9	0.35	1.3	0.2	3.25	1.45	3.55	2.4

Issue date ~~11-06-27~~  
11-07-06

sot1159-1\_fr

Reflow soldering is the only recommended soldering method.

**Fig 18. Reflow soldering PEMI8QFN (SOT1159-1/HXSON16)**

## 10. Revision history

**Table 12. Revision history**

Document ID	Release date	Data sheet status	Change notice	Supersedes
PEMIXQFN_PEMI2STD_FAM v.2	20111103	Product data sheet	-	PEMIXQFN_PEMI2STD_FAM v.1
Modifications:	<ul style="list-style-type: none"> <li>• <a href="#">Table 3 "Pinning"</a>: corrected pinning description for PEMI8QFN (SOT1159-1); updated simplified outline of SOT886</li> <li>• <a href="#">Section 11 "Legal information"</a>: updated</li> </ul>			
PEMIXQFN_PEMI2STD_FAM v.1	20110729	Product data sheet	-	-

## 11. Legal information

### 11.1 Data sheet status

Document status <sup>[1][2]</sup>	Product status <sup>[3]</sup>	Definition
Objective [short] data sheet	Development	This document contains data from the objective specification for product development.
Preliminary [short] data sheet	Qualification	This document contains data from the preliminary specification.
Product [short] data sheet	Production	This document contains the product specification.

[1] Please consult the most recently issued document before initiating or completing a design.

[2] The term 'short data sheet' is explained in section "Definitions".

[3] The product status of device(s) described in this document may have changed since this document was published and may differ in case of multiple devices. The latest product status information is available on the Internet at URL <http://www.nxp.com>.

### 11.2 Definitions

**Draft** — The document is a draft version only. The content is still under internal review and subject to formal approval, which may result in modifications or additions. NXP Semiconductors does not give any representations or warranties as to the accuracy or completeness of information included herein and shall have no liability for the consequences of use of such information.

**Short data sheet** — A short data sheet is an extract from a full data sheet with the same product type number(s) and title. A short data sheet is intended for quick reference only and should not be relied upon to contain detailed and full information. For detailed and full information see the relevant full data sheet, which is available on request via the local NXP Semiconductors sales office. In case of any inconsistency or conflict with the short data sheet, the full data sheet shall prevail.

**Product specification** — The information and data provided in a Product data sheet shall define the specification of the product as agreed between NXP Semiconductors and its customer, unless NXP Semiconductors and customer have explicitly agreed otherwise in writing. In no event however, shall an agreement be valid in which the NXP Semiconductors product is deemed to offer functions and qualities beyond those described in the Product data sheet.

### 11.3 Disclaimers

**Limited warranty and liability** — Information in this document is believed to be accurate and reliable. However, NXP Semiconductors does not give any representations or warranties, expressed or implied, as to the accuracy or completeness of such information and shall have no liability for the consequences of use of such information.

In no event shall NXP Semiconductors be liable for any indirect, incidental, punitive, special or consequential damages (including - without limitation - lost profits, lost savings, business interruption, costs related to the removal or replacement of any products or rework charges) whether or not such damages are based on tort (including negligence), warranty, breach of contract or any other legal theory.

Notwithstanding any damages that customer might incur for any reason whatsoever, NXP Semiconductors' aggregate and cumulative liability towards customer for the products described herein shall be limited in accordance with the *Terms and conditions of commercial sale* of NXP Semiconductors.

**Right to make changes** — NXP Semiconductors reserves the right to make changes to information published in this document, including without limitation specifications and product descriptions, at any time and without notice. This document supersedes and replaces all information supplied prior to the publication hereof.

**Suitability for use** — NXP Semiconductors products are not designed, authorized or warranted to be suitable for use in life support, life-critical or safety-critical systems or equipment, nor in applications where failure or

malfunction of an NXP Semiconductors product can reasonably be expected to result in personal injury, death or severe property or environmental damage. NXP Semiconductors accepts no liability for inclusion and/or use of NXP Semiconductors products in such equipment or applications and therefore such inclusion and/or use is at the customer's own risk.

**Applications** — Applications that are described herein for any of these products are for illustrative purposes only. NXP Semiconductors makes no representation or warranty that such applications will be suitable for the specified use without further testing or modification.

Customers are responsible for the design and operation of their applications and products using NXP Semiconductors products, and NXP Semiconductors accepts no liability for any assistance with applications or customer product design. It is customer's sole responsibility to determine whether the NXP Semiconductors product is suitable and fit for the customer's applications and products planned, as well as for the planned application and use of customer's third party customer(s). Customers should provide appropriate design and operating safeguards to minimize the risks associated with their applications and products.

NXP Semiconductors does not accept any liability related to any default, damage, costs or problem which is based on any weakness or default in the customer's applications or products, or the application or use by customer's third party customer(s). Customer is responsible for doing all necessary testing for the customer's applications and products using NXP Semiconductors products in order to avoid a default of the applications and the products or of the application or use by customer's third party customer(s). NXP does not accept any liability in this respect.

**Limiting values** — Stress above one or more limiting values (as defined in the Absolute Maximum Ratings System of IEC 60134) will cause permanent damage to the device. Limiting values are stress ratings only and (proper) operation of the device at these or any other conditions above those given in the Recommended operating conditions section (if present) or the Characteristics sections of this document is not warranted. Constant or repeated exposure to limiting values will permanently and irreversibly affect the quality and reliability of the device.

**Terms and conditions of commercial sale** — NXP Semiconductors products are sold subject to the general terms and conditions of commercial sale, as published at <http://www.nxp.com/profile/terms>, unless otherwise agreed in a valid written individual agreement. In case an individual agreement is concluded only the terms and conditions of the respective agreement shall apply. NXP Semiconductors hereby expressly objects to applying the customer's general terms and conditions with regard to the purchase of NXP Semiconductors products by customer.

**No offer to sell or license** — Nothing in this document may be interpreted or construed as an offer to sell products that is open for acceptance or the grant, conveyance or implication of any license under any copyrights, patents or other industrial or intellectual property rights.

**Export control** — This document as well as the item(s) described herein may be subject to export control regulations. Export might require a prior authorization from competent authorities.

**Quick reference data** — The Quick reference data is an extract of the product data given in the Limiting values and Characteristics sections of this document, and as such is not complete, exhaustive or legally binding.

**Non-automotive qualified products** — Unless this data sheet expressly states that this specific NXP Semiconductors product is automotive qualified, the product is not suitable for automotive use. It is neither qualified nor tested in accordance with automotive testing or application requirements. NXP Semiconductors accepts no liability for inclusion and/or use of non-automotive qualified products in automotive equipment or applications.

In the event that customer uses the product for design-in and use in automotive applications to automotive specifications and standards, customer (a) shall use the product without NXP Semiconductors' warranty of the

product for such automotive applications, use and specifications, and (b) whenever customer uses the product for automotive applications beyond NXP Semiconductors' specifications such use shall be solely at customer's own risk, and (c) customer fully indemnifies NXP Semiconductors for any liability, damages or failed product claims resulting from customer design and use of the product for automotive applications beyond NXP Semiconductors' standard warranty and NXP Semiconductors' product specifications.

## 11.4 Trademarks

Notice: All referenced brands, product names, service names and trademarks are the property of their respective owners.

## 12. Contact information

For more information, please visit: <http://www.nxp.com>

For sales office addresses, please send an email to: [salesaddresses@nxp.com](mailto:salesaddresses@nxp.com)

## 13. Contents

<b>1</b>	<b>Product profile</b> . . . . .	<b>1</b>
1.1	General description . . . . .	1
1.2	Features and benefits . . . . .	1
1.3	Applications . . . . .	1
1.4	Quick reference data . . . . .	2
<b>2</b>	<b>Pinning information</b> . . . . .	<b>2</b>
<b>3</b>	<b>Ordering information</b> . . . . .	<b>4</b>
<b>4</b>	<b>Limiting values</b> . . . . .	<b>4</b>
<b>5</b>	<b>Characteristics</b> . . . . .	<b>5</b>
<b>6</b>	<b>Application information</b> . . . . .	<b>9</b>
6.1	Use cases . . . . .	9
6.2	LCD interfaces, medium-speed interfaces . . . . .	9
6.3	Keypad, low-speed interfaces . . . . .	9
6.4	Insertion loss . . . . .	10
6.4.1	Relative -3dB frequency (p-filter structure) . . . . .	12
6.4.2	Insertion loss (dB) at 800 MHz (p-filter structure) . . . . .	13
6.4.3	Insertion loss (dB) at frequencies lower than 1 MHz (p-filter structure) . . . . .	13
<b>7</b>	<b>Marking</b> . . . . .	<b>13</b>
<b>8</b>	<b>Package outline</b> . . . . .	<b>15</b>
<b>9</b>	<b>Soldering</b> . . . . .	<b>21</b>
<b>10</b>	<b>Revision history</b> . . . . .	<b>26</b>
<b>11</b>	<b>Legal information</b> . . . . .	<b>27</b>
11.1	Data sheet status . . . . .	27
11.2	Definitions . . . . .	27
11.3	Disclaimers . . . . .	27
11.4	Trademarks . . . . .	28
<b>12</b>	<b>Contact information</b> . . . . .	<b>28</b>
<b>13</b>	<b>Contents</b> . . . . .	<b>29</b>

Please be aware that important notices concerning this document and the product(s) described herein, have been included in section 'Legal information'.

© NXP B.V. 2011.

All rights reserved.

For more information, please visit: <http://www.nxp.com>

For sales office addresses, please send an email to: [salesaddresses@nxp.com](mailto:salesaddresses@nxp.com)

Date of release: 3 November 2011

Document identifier: PEMIXQFN\_PEMI2STD\_FAM