

National Semiconductor is now part of
Texas Instruments.

Search <http://www.ti.com/> for the latest technical
information and details on our current products and services.

DS90LV011AH

High Temperature 3V LVDS Differential Driver

General Description

The DS90LV011AH is an LVDS driver optimized for high data rate and low power applications. The DS90LV011AH is a current mode driver allowing power dissipation to remain low even at high frequency. In addition, the short circuit fault current is also minimized. The device is designed to support data rates in excess of 400Mbps (200MHz) utilizing Low Voltage Differential Signaling (LVDS) technology.

The device is offered in a 5-lead small outline transistor package. The LVDS outputs have been arranged for easy PCB layout. The differential driver outputs provide low EMI with its typical low output swing of 350 mV. The DS90LV011AH can be paired with its companion single line receiver, the DS90LT012AH, or with any of National's LVDS receivers, to provide a high-speed LVDS interface.

Features

- -40°C to 125°C operating temperature range
- Conforms to TIA/EIA-644-A Standard
- >400Mbps (200MHz) switching rates
- 700 ps (100 ps typical) maximum differential skew
- 1.5 ns maximum propagation delay
- Single 3.3V power supply
- ±350 mV differential signaling
- Power Off Protection (outputs in TRI-STATE)
- Pinout simplifies PCB layout
- Low power dissipation (23 mW @ 3.3V typical)
- SOT-23 5-lead package
- Pin compatible with SN65LVDS1

Connection Diagram

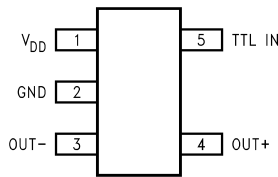

20161522

(Top View)

Order Number DS90LV011AHMF
See NS Package Number MF05A

Functional Diagram

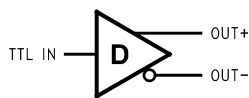

20161502

Absolute Maximum Ratings (Note 1)

If Military/Aerospace specified devices are required, please contact the National Semiconductor Sales Office/Distributors for availability and specifications.

Supply Voltage (V_{DD})	-0.3V to +4V
LVC MOS input voltage (TTL IN)	-0.3V to +3.6V
LVDS output voltage (OUT_{\pm})	-0.3V to +3.9V
LVDS output short circuit current	24mA
Maximum Package Power Dissipation @ +25°C	
MF Package	902 mW
Derate MF Package	7.22 mW/°C above +25°C
Thermal resistance (θ_{JA})	138.5°C/Watt
Storage Temperature	-65°C to +150°C
Lead Temperature Range Soldering (4 sec.)	+260°C

Maximum Junction Temperature	+150°C
ESD Ratings	
HBM (1.5 k Ω , 100 pF)	≥ 9kV
EIAJ (0 Ω , 200 pF)	≥ 900V
CDM (0 Ω , 0 pF)	≥ 2000V
IEC direct (330 Ω , 150 pF)	≥ 4kV

Recommended Operating Conditions

	Min	Typ	Max	Units
Supply Voltage (V_{DD})	3.0	3.3	3.6	V
Temperature (T_A)	-40	+25	+125	°C

Electrical Characteristics

Over Supply Voltage and Operating Temperature ranges, unless otherwise specified. (Notes 2, 3, 8)

Symbol	Parameter	Conditions	Pin	Min	Typ	Max	Units
$ V_{OD} $	Output Differential Voltage	$R_L = 100\Omega$	OUT+, OUT-	250	350	450	mV
ΔV_{OD}	V_{OD} Magnitude Change	(Figure 1 and Figure 2)			3	35	mV
V_{OS}	Offset Voltage	$R_L = 100\Omega$		1.125	1.22	1.375	V
ΔV_{OS}	Offset Magnitude Change	(Figure 1)		0	1	25	mV
I_{OFF}	Power-off Leakage	$V_{OUT} = 3.6V$ or GND, $V_{DD} = 0V$			±1	±10	μA
I_{OS}	Output Short Circuit Current (Note 4)	V_{OUT+} and $V_{OUT-} = 0V$			-6	-24	mA
I_{OSD}	Differential Output Short Circuit Current (Note 4)	$V_{OD} = 0V$			-5	-12	mA
C_{OUT}	Output Capacitance				3		pF
V_{IH}	Input High Voltage		TTL IN	2.0		V_{DD}	V
V_{IL}	Input Low Voltage			GND		0.8	V
I_{IH}	Input High Current	$V_{IN} = 3.3V$ or 2.4V			±2	±10	μA
I_{IL}	Input Low Current	$V_{IN} = GND$ or 0.5V			±1	±10	μA
V_{CL}	Input Clamp Voltage	$I_{CL} = -18$ mA		-1.5	-0.6		V
C_{IN}	Input Capacitance				3		pF
I_{DD}	Power Supply Current	No Load	$V_{IN} = V_{DD}$ or GND	V_{DD}	5	8	mA
		$R_L = 100\Omega$			7	10	mA

Switching Characteristics

Over Supply Voltage and Operating Temperature Ranges, unless otherwise specified. (Notes 3, 5, 6, 7)

Symbol	Parameter	Conditions	Min	Typ	Max	Units
t_{PHLD}	Differential Propagation Delay High to Low	$R_L = 100\Omega$, $C_L = 15$ pF (Figure 3 and Figure 4)	0.3	1.0	1.5	ns
t_{PLHD}	Differential Propagation Delay Low to High		0.3	1.1	1.5	ns
t_{SKD1}	Differential Pulse Skew $ t_{PHLD} - t_{PLHD} $ (Note 9)		0	0.1	0.7	ns
t_{SKD3}	Differential Part to Part Skew (Note 10)		0	0.2	1.0	ns
t_{SKD4}	Differential Part to Part Skew (Note 11)		0	0.4	1.2	ns
t_{TLH}	Transition Low to High Time		0.2	0.5	1.0	ns
t_{THL}	Transition High to Low Time		0.2	0.5	1.0	ns
f_{MAX}	Maximum Operating Frequency (Note 12)		200	250		MHz

Note 1: "Absolute Maximum Ratings" are those values beyond which the safety of the device cannot be guaranteed. They are not meant to imply that the devices should be operated at these limits. The table of "Electrical Characteristics" specifies conditions of device operation.

Note 2: Current into device pins is defined as positive. Current out of device pins is defined as negative. All voltages are referenced to ground except V_{OD} .

Note 3: All typicals are given for: $V_{DD} = +3.3V$ and $T_A = +25^\circ C$.

Switching Characteristics (Continued)

Note 4: Output short circuit current (I_{OS}) is specified as magnitude only, minus sign indicates direction only.

Note 5: These parameters are guaranteed by design. The limits are based on statistical analysis of the device performance over PVT (process, voltage, temperature) ranges.

Note 6: C_L includes probe and fixture capacitance.

Note 7: Generator waveform for all tests unless otherwise specified: $f = 1$ MHz, $Z_O = 50\Omega$, $t_r \leq 1$ ns, $t_f \leq 1$ ns (10%-90%).

Note 8: The DS90LV011AH is a current mode device and only function with datasheet specification when a resistive load is applied to the drivers outputs.

Note 9: t_{SKD1} , $|t_{PHLD} - t_{PLHD}|$, is the magnitude difference in differential propagation delay time between the positive going edge and the negative going edge of the same channel.

Note 10: t_{SKD3} , Differential Part to Part Skew, is defined as the difference between the minimum and maximum specified differential propagation delays. This specification applies to devices at the same V_{DD} and within 5°C of each other within the operating temperature range.

Note 11: t_{SKD4} , part to part skew, is the differential channel to channel skew of any event between devices. This specification applies to devices over recommended operating temperature and voltage ranges, and across process distribution. t_{SKD4} is defined as $I_{Max} - I_{Min}$ differential propagation delay.

Note 12: f_{MAX} generator input conditions: $t_r = t_f < 1$ ns (0% to 100%), 50% duty cycle, 0V to 3V. Output criteria: duty cycle = 45%/55%, $V_{OD} > 250$ mV. The parameter is guaranteed by design. The limit is based on the statistical analysis of the device over the PVT range by the transitions times (t_{TLH} and t_{THL}).

Parameter Measurement Information

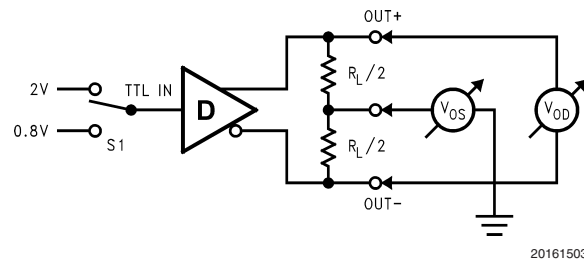

FIGURE 1. Differential Driver DC Test Circuit

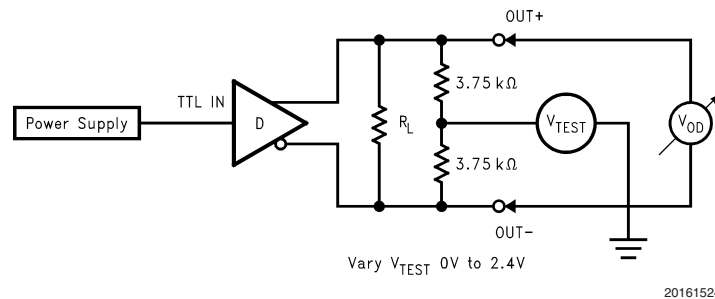

FIGURE 2. Differential Driver Full Load DC Test Circuit

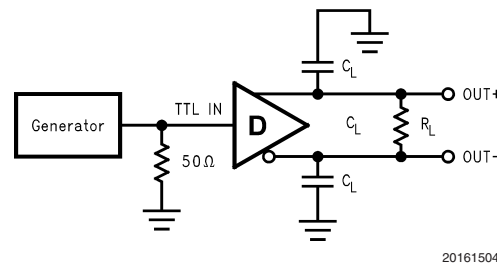

FIGURE 3. Differential Driver Propagation Delay and Transition Time Test Circuit

Parameter Measurement Information (Continued)

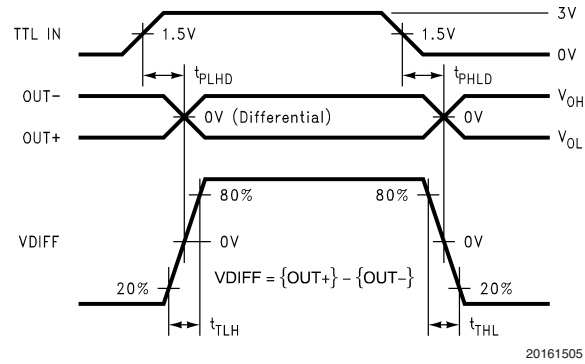

FIGURE 4. Differential Driver Propagation Delay and Transition Time Waveforms

Application Information

TABLE 1. Device Pin Descriptions

Package Pin Number	Pin Name	Description
SOT23		
5	TTL IN	LVTTL/LVCMOS driver input pins
4	OUT+	Non-inverting driver output pin
3	OUT-	Inverting driver output pin
2	GND	Ground pin
1	V_{DD}	Power supply pin, +3.3V \pm 0.3V
	NC	No connect

Physical Dimensions inches (millimeters) unless otherwise noted

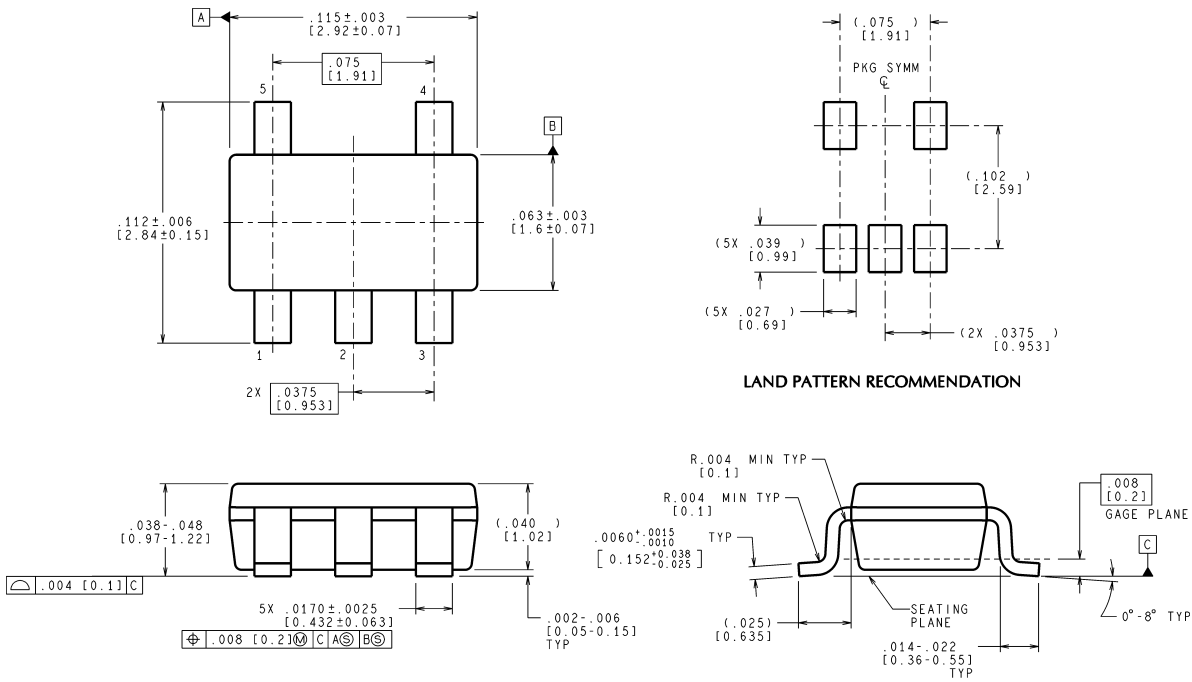

CONTROLLING DIMENSION IS INCH
VALUES IN [] ARE MILLIMETERS

MF05A (Rev B)

5-Lead SOT23, JEDEC MO-178, 1.6mm
Order Number DS90LV011AHMF
NS Package Number MF05A

National does not assume any responsibility for use of any circuitry described, no circuit patent licenses are implied and National reserves the right at any time without notice to change said circuitry and specifications.

For the most current product information visit us at www.national.com.

LIFE SUPPORT POLICY

NATIONAL'S PRODUCTS ARE NOT AUTHORIZED FOR USE AS CRITICAL COMPONENTS IN LIFE SUPPORT DEVICES OR SYSTEMS WITHOUT THE EXPRESS WRITTEN APPROVAL OF THE PRESIDENT AND GENERAL COUNSEL OF NATIONAL SEMICONDUCTOR CORPORATION. As used herein:

1. Life support devices or systems are devices or systems which, (a) are intended for surgical implant into the body, or (b) support or sustain life, and whose failure to perform when properly used in accordance with instructions for use provided in the labeling, can be reasonably expected to result in a significant injury to the user.
2. A critical component is any component of a life support device or system whose failure to perform can be reasonably expected to cause the failure of the life support device or system, or to affect its safety or effectiveness.

BANNED SUBSTANCE COMPLIANCE

National Semiconductor manufactures products and uses packing materials that meet the provisions of the Customer Products Stewardship Specification (CSP-9-111C2) and the Banned Substances and Materials of Interest Specification (CSP-9-111S2) and contain no "Banned Substances" as defined in CSP-9-111S2.

Leadfree products are RoHS compliant.



National Semiconductor
Americas Customer Support Center
Email: new.feedback@nsc.com
Tel: 1-800-272-9959

National Semiconductor
Europe Customer Support Center
Fax: +49 (0) 180-530 85 86
Email: europe.support@nsc.com
Deutsch Tel: +49 (0) 69 9508 6208
English Tel: +44 (0) 870 24 0 2171
Français Tel: +33 (0) 1 41 91 8790

National Semiconductor
Asia Pacific Customer Support Center
Email: ap.support@nsc.com

National Semiconductor
Japan Customer Support Center
Fax: 81-3-5639-7507
Email: jpn.feedback@nsc.com
Tel: 81-3-5639-7560