

## FEATURES

### High performance

High relative accuracy (INL):  $\pm 4$  LSB maximum at 16 bits  
(AD5677R only)

TUE:  $\pm 0.14\%$  of FSR maximum

Offset error:  $\pm 1.5$  mV maximum

Gain error:  $\pm 0.06\%$  of FSR maximum

Low drift, 2.5 V voltage reference TC: 2 ppm/°C typical

40 mA short-circuit current

### Wide operating ranges

$-40^{\circ}\text{C}$  to  $+125^{\circ}\text{C}$  temperature range

2.7 V to 5.5 V power supply range

### Simplified implementation

User selectable gain of 1 or 2 (GAIN pin)

1.8 V logic compatibility

400 kHz I<sup>2</sup>C-compatible serial interface

28-lead, 4 mm  $\times$  4 mm, RoHS compliant LFCSP

## APPLICATIONS

Optical transceivers

Base station power amplifiers

Process control (programmable logic controller (PLC)

input/output cards)

Industrial automation

Data acquisition systems

## GENERAL DESCRIPTION

The AD5673R/AD5677R are low power, 16-channel, 12-/16-bit, buffered voltage output, digital-to-analog converters (DACs) that include a 2.5 V, 2 ppm/°C internal reference (enabled by default), and a gain select pin, resulting in a full-scale output of 2.5 V (gain = 1) or 5 V (gain = 2). The devices operate from a single, 2.7 V to 5.5 V supply range and are guaranteed monotonic by design. The AD5673R/AD5677R are available in a 28-lead lead frame chip scale package (LFCSP) and incorporate a power-on reset (POR) circuit that ensures that the DAC outputs power up to and remain at zero scale or midscale until a valid write. The AD5673R/AD5677R contain a power-down mode that reduces the current consumption to 2  $\mu\text{A}$  typical.

Table 1. Octal and 16-Channel *nanoDAC+*® Devices

| Channel Count | Interface        | Reference | 16-Bit  | 12-Bit         |
|---------------|------------------|-----------|---------|----------------|
| 8             | SPI              | Internal  | AD5676R | AD5672R        |
|               |                  | External  | AD5676  | Not applicable |
|               | I <sup>2</sup> C | Internal  | AD5675R | AD5671R        |
| 16            | SPI              | Internal  | AD5679R | AD5674R        |
|               |                  | External  | AD5679  | AD5674         |
|               | I <sup>2</sup> C | Internal  | AD5677R | AD5673R        |

## PRODUCT HIGHLIGHTS

- High channel density: 16 channels in 4 mm  $\times$  4 mm LFCSP.
- High relative accuracy (INL).  
AD5673R (12-bit):  $\pm 1$  LSB maximum.  
AD5677R (16-bit):  $\pm 4$  LSB maximum.
- Low drift, 2.5 V, on-chip reference.

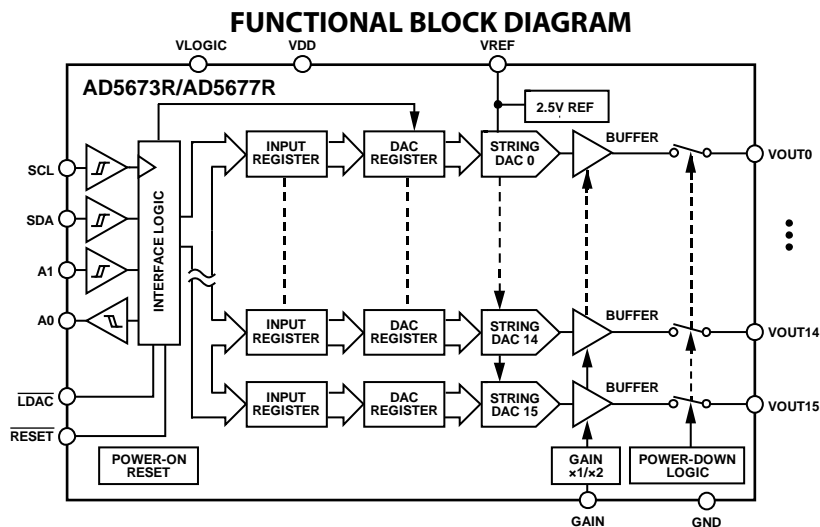

Figure 1.

Rev. 0

[Document Feedback](#)

Information furnished by Analog Devices is believed to be accurate and reliable. However, no responsibility is assumed by Analog Devices for its use, nor for any infringements of patents or other rights of third parties that may result from its use. Specifications subject to change without notice. No license is granted by implication or otherwise under any patent or patent rights of Analog Devices. Trademarks and registered trademarks are the property of their respective owners.

## TABLE OF CONTENTS

|  |    |   |    |
|--|----|---|----|
| Features .....                                   | 1  | I <sup>2</sup> C Slave Address.....                   | 25 |
| Applications.....                                | 1  | Serial Operation .....                                | 25 |
| General Description .....                        | 1  | Write Operation.....                                  | 25 |
| Product Highlights .....                         | 1  | Read Operation.....                                   | 25 |
| Functional Block Diagram .....                   | 1  | Multiple DAC Readback Sequence .....                  | 25 |
| Revision History .....                           | 2  | Power-Down Operation .....                            | 27 |
| Specifications.....                              | 3  | Load DAC (Hardware $\overline{\text{LDAC}}$ Pin)..... | 27 |
| AD5673R Specifications .....                     | 3  | $\overline{\text{LDAC}}$ Mask Register .....          | 28 |
| AD5677R Specifications .....                     | 5  | Hardware Reset ( $\overline{\text{RESET}}$ ) .....    | 28 |
| AC Characteristics.....                          | 7  | Power-On Reset Internal Circuit.....                  | 28 |
| Timing Characteristics .....                     | 8  | Software Reset.....                                   | 28 |
| Absolute Maximum Ratings.....                    | 9  | Internal Reference Setup .....                        | 28 |
| Thermal Resistance .....                         | 9  | Solder Heat Reflow.....                               | 29 |
| ESD Caution.....                                 | 9  | Long-Term Temperature Drift .....                     | 29 |
| Pin Configuration and Function Descriptions..... | 10 | Thermal Hysteresis .....                              | 29 |
| Typical Performance Characteristics .....        | 12 | Applications Information .....                        | 30 |
| Terminology .....                                | 21 | Power Supply Recommendations.....                     | 30 |
| Theory of Operation .....                        | 23 | Microprocessor Interfacing.....                       | 30 |
| Digital-to-Analog Converter (DAC) .....          | 23 | AD5673R/AD5677R to ADSP-BF531 Interface.....          | 30 |
| Transfer Function .....                          | 23 | Layout Guidelines.....                                | 30 |
| DAC Architecture.....                            | 23 | Galvanically Isolated Interface .....                 | 30 |
| Serial Interface .....                           | 23 | Outline Dimensions .....                              | 31 |
| Write and Update Commands.....                   | 25 | Ordering Guide .....                                  | 31 |

## REVISION HISTORY

4/2020—Revision 0: Initial Version

## SPECIFICATIONS

### AD5673R SPECIFICATIONS

V<sub>DD</sub> pin voltage (V<sub>DD</sub>) = 2.7 V to 5.5 V, 1.62 V ≤ V<sub>LOGIC</sub> pin voltage (V<sub>LOGIC</sub>) ≤ 5.5 V, load resistance (R<sub>L</sub>) = 2 kΩ, load capacitance (C<sub>L</sub>) = 200 pF, all specifications are T<sub>J</sub> = −40°C to +125°C, typical at T<sub>A</sub> = 25°C, unless otherwise noted.

Table 2.

| Parameter                                      | Min | Typ    | Max                | Unit     | Test Conditions/Comments   |
|--|-----|--------|--------------------|----------|--|
| <b>STATIC PERFORMANCE<sup>1</sup></b>          |     |        |                    |          |  |
| Resolution                                     | 12  |        |                    | Bits     |  |
| Relative Accuracy, Integral Nonlinearity (INL) |     | ±0.12  | ±1                 | LSB      | Gain = 1   |
| Differential Nonlinearity (DNL)                |     | ±0.12  | ±1                 | LSB      | Gain = 2   |
|  |     | ±0.05  | ±0.1               | LSB      | Gain = 1   |
| Zero Code Error                                |     | ±0.05  | ±0.1               | LSB      | Gain = 2   |
|  |     | 0.8    | 1.6                | mV       | Gain = 1 or gain = 2   |
| Offset Error                                   |     | −0.75  | ±2                 | mV       | Gain = 1   |
|  |     | −0.1   | ±1.5               | mV       | Gain = 2   |
| Full-Scale Error                               |     | −0.018 | ±0.14              | % of FSR | Gain = 1   |
|  |     | −0.013 | ±0.07              | % of FSR | Gain = 2, V <sub>DD</sub> = 5.5 V  |
| Gain Error                                     |     | +0.04  | ±0.12              | % of FSR | Gain = 1   |
|  |     | −0.02  | ±0.06              | % of FSR | Gain = 2   |
| Total Unadjusted Error (TUE)                   |     | ±0.03  | ±0.18              | % of FSR | Gain = 1   |
|  |     | ±0.006 | ±0.14              | % of FSR | Gain = 2   |
| Offset Error Drift                             |     | ±2     |                    | μV/°C    | Gain = 1   |
| DC Power Supply Rejection Ratio (PSRR)         |     | 0.25   |                    | mV/V     | DAC code = midscale, V <sub>DD</sub> = 5 V ± 10%   |
| DC Crosstalk                                   |     | ±2     |                    | μV       | Due to single channel, full-scale output change, internal reference, gain = 1                          |
|  |     | ±3     |                    | μV/mA    | Due to load current change, external reference, gain = 2   |
|  |     | ±2     |                    | μV       | Due to powering down (per channel), internal reference, gain = 1                                       |
| <b>OUTPUT CHARACTERISTICS</b>                  |     |        |                    |          |  |
| Output Power-Up Voltage                        |     | 0      |                    | V        | Gain = 1, AD5673R-1  |
|  |     | 0      |                    | V        | Gain = 2, AD5673R-1  |
|  |     | 1.25   |                    | V        | Gain = 1, AD5673R-2  |
|  |     | 2.5    |                    | V        | Gain = 2, AD5673R-2  |
| Output Voltage Range                           | 0   |        | 2.5                | V        | Gain = 1   |
|  | 0   |        | 5                  | V        | Gain = 2   |
| Capacitive Load Stability                      |     | 2      |                    | nF       | R <sub>L</sub> = ∞   |
|  |     | 10     |                    | nF       | R <sub>L</sub> = 1 kΩ  |
| Load Regulation                                |     | 183    |                    | μV/mA    | V <sub>DD</sub> = 5 V ± 10%, DAC code = midscale, −30 mA ≤ output current (I <sub>OUT</sub> ) ≤ +30 mA |
|  |     | 177    |                    | μV/mA    | V <sub>DD</sub> = 3 V ± 10%, DAC code = midscale, −20 mA ≤ I <sub>OUT</sub> ≤ +20 mA                   |
| Short-Circuit Current <sup>2</sup>             |     | 40     |                    | mA       |  |
| Load Impedance at Rails <sup>3</sup>           |     | 25     |                    | Ω        |  |
| Power-Up Time                                  |     | 3      |                    | μs       | Exiting power-down mode, V <sub>DD</sub> = 5 V   |
| <b>REFERENCE INPUT</b>                         |     |        |                    |          |  |
| Reference Input Current                        |     | 0.8    |                    | mA       | Reference voltage (V <sub>REF</sub> ) = V <sub>DD</sub> = V <sub>LOGIC</sub> = 5.5 V, gain = 1         |
| Reference Input Range                          |     | 1.6    |                    | mA       | V <sub>REF</sub> = V <sub>DD</sub> = V <sub>LOGIC</sub> = 5.5 V, gain = 2                              |
|  | 1   |        | V <sub>DD</sub>    | V        | Gain = 1   |
| Reference Input Impedance                      | 1   |        | V <sub>DD</sub> /2 | V        | Gain = 2   |
|  |     | 7      |                    | kΩ       | Gain = 1   |
|  |     | 3.5    |                    | kΩ       | Gain = 2   |

| Parameter  | Min                      | Typ  | Max                       | Unit   | Test Conditions/Comments  |
|--|--------------------------|------|---------------------------|--------|---|
| <b>REFERENCE OUTPUT</b>  |                          |      |                           |        |   |
| Output Voltage <sup>4</sup>  | 2.4975                   |      | 2.5025                    | V      |   |
| Voltage Reference Temperature Coefficient (TC) <sup>5, 6</sup>             |                          | 2    | 5                         | ppm/°C | See voltage reference temperature coefficient (TC) in the Terminology section   |
| Output Impedance   |                          | 0.04 |                           | Ω      |   |
| Output Voltage Noise   |                          | 13   |                           | μV p-p | 0.1 Hz to 10 Hz   |
| Output Voltage Noise Density   |                          | 240  |                           | nV/√Hz | At ambient temperature (T <sub>A</sub> ), f = 10 kHz, C <sub>L</sub> = 10 nF, gain = 1 or 2   |
| Load Regulation Sourcing   |                          | 29   |                           | μV/mA  | At T <sub>A</sub>   |
| Load Regulation Sinking  |                          | 74   |                           | μV/mA  | At T <sub>A</sub>   |
| Output Current Load Capability   |                          | ±20  |                           | mA     | V <sub>DD</sub> ≥ 3 V   |
| Line Regulation  |                          | 43   |                           | μV/V   | At T <sub>A</sub>   |
| Long-Term Stability Drift  |                          | 77   |                           | ppm    | After 1000 hours at 25°C  |
| Thermal Hysteresis   |                          | 125  |                           | ppm    | First cycle   |
|  |                          | 25   |                           | ppm    | Additional cycles   |
| <b>LOGIC INPUTS</b>  |                          |      |                           |        |   |
| Input Current  |                          |      | ±1                        | μA     | Per pin   |
| Input Voltage Low, V <sub>IL</sub>   |                          |      | 0.3 × V <sub>LOGIC</sub>  | V      | 1.62 V ≤ V <sub>LOGIC</sub> ≤ 3.3 V   |
| Input Voltage High, V <sub>IH</sub>  | 0.7 × V <sub>LOGIC</sub> |      | 0.25 × V <sub>LOGIC</sub> | V      | 3.3 V ≤ V <sub>LOGIC</sub> ≤ 5.5 V  |
| Pin Capacitance  |                          | 4    |                           | pF     |   |
| <b>LOGIC OUTPUTS (SDA)</b>   |                          |      |                           |        |   |
| Output Voltage Low, V <sub>OL</sub>  |                          |      | 0.4                       | V      | Output low current (I <sub>OL</sub> ) = 3 mA  |
| Output Voltage High, V <sub>OH</sub>                                       | V <sub>LOGIC</sub> - 0.4 |      |                           | V      | Output high current (I <sub>OH</sub> ) = -3 mA  |
| Floating State Output Capacitance  |                          | 9    |                           | pF     |   |
| <b>POWER REQUIREMENTS</b>  |                          |      |                           |        |   |
| V <sub>LOGIC</sub>   | 1.62                     |      | 5.5                       | V      | 1.8 V logic compatibility   |
| V <sub>LOGIC</sub> Supply Current (I <sub>LOGIC</sub> )                    |                          |      | 3                         | μA     | Power-on, -40°C to +105°C   |
|  |                          |      | 3                         | μA     | Power-on, -40°C to +125°C   |
|  |                          |      | 3                         | μA     | Power-down, -40°C to +105°C   |
|  |                          |      | 3                         | μA     | Power-down, -40°C to +125°C   |
| V <sub>DD</sub>  | 2.7                      |      | 5.5                       | V      | Gain = 1  |
|  | V <sub>REF</sub> + 1.5   |      | 5.5                       | V      | Gain = 2  |
| V <sub>DD</sub> Supply Current (I <sub>DD</sub> ) Normal Mode <sup>7</sup> |                          | 2.3  | 2.53                      | mA     | V <sub>IH</sub> = V <sub>DD</sub> , V <sub>IL</sub> = GND, V <sub>DD</sub> = 2.7 V to 5.5 V<br>Internal reference off, -40°C to +85°C |
|  |                          | 3.4  | 3.8                       | mA     | Internal reference on, -40°C to +85°C   |
|  |                          | 2.3  | 2.6                       | mA     | Internal reference off  |
|  |                          | 3.4  | 4.2                       | mA     | Internal reference on   |
| All Power-Down Modes <sup>8</sup>  |                          | 2    | 3.4                       | μA     | Power-down to 1 kΩ, -40°C to +85°C  |
|  |                          | 2    | 5                         | μA     | Power-down to 1 kΩ, -40°C to +105°C   |
|  |                          | 2    | 11                        | μA     | Power-down to 1 kΩ, -40°C to +125°C   |

<sup>1</sup> DC specifications tested with the outputs unloaded, unless otherwise noted. Upper dead band = 10 mV and exists only when V<sub>REF</sub> = V<sub>DD</sub> with gain = 1, or when V<sub>REF</sub>/2 = V<sub>DD</sub> with gain = 2. Linearity calculated using a reduced code range of 12 to 4080.

<sup>2</sup> V<sub>DD</sub> = 5 V. The device includes current limiting intended to protect the devices during temporary overload conditions. Junction temperature (T<sub>J</sub>) can be exceeded during current limit. Operation above the specified maximum operation junction temperature can impair device reliability.

<sup>3</sup> When drawing a load current at either rail, the output voltage headroom with respect to that rail is limited by the 25 Ω typical channel resistance of the output devices. For example, when sinking 1 mA, the minimum output voltage = 25 Ω × 1 mA = 25 mV.

<sup>4</sup> Initial accuracy presolder reflow is ±750 μV. Output voltage includes the effects of preconditioning drift. See the Internal Reference Setup section.

<sup>5</sup> Reference is trimmed and tested at two temperatures and is characterized from -40°C to +125°C.

<sup>6</sup> Voltage reference temperature coefficient is calculated as per the box method. See the voltage reference temperature coefficient (TC) definition in the Terminology section for further information.

<sup>7</sup> Interface inactive. All DACs active. DAC outputs unloaded.

<sup>8</sup> All DACs powered down.

**AD5677R SPECIFICATIONS**

$V_{DD} = 2.7\text{ V to }5.5\text{ V}$ ,  $1.62\text{ V} \leq V_{LOGIC} \leq 5.5\text{ V}$ ,  $R_L = 2\text{ k}\Omega$ ,  $C_L = 200\text{ pF}$ , all specifications are  $T_J = -40^\circ\text{C to }+125^\circ\text{C}$ , typical at  $T_A = 25^\circ\text{C}$ , unless otherwise noted.

**Table 3.**

| Parameter                             | Min    | Typ         | Max        | Unit                         | Test Conditions/Comments  |
|---------------------------------------|--------|-------------|------------|------------------------------|---|
| <b>STATIC PERFORMANCE<sup>1</sup></b> |        |             |            |                              |   |
| Resolution                            | 16     |             |            | Bits                         |   |
| INL                                   |        | $\pm 1.8$   | $\pm 4$    | LSB                          | Gain = 1  |
|                                       |        | $\pm 1.7$   | $\pm 4$    | LSB                          | Gain = 2  |
| DNL                                   |        | $\pm 0.7$   | $\pm 1$    | LSB                          | Gain = 1  |
|                                       |        | $\pm 0.5$   | $\pm 1$    | LSB                          | Gain = 2  |
| Zero Code Error                       |        | 0.8         | 1.6        | mV                           | Gain = 1 or gain = 2  |
| Offset Error                          |        | $-0.75$     | $\pm 2$    | mV                           | Gain = 1  |
|                                       |        | $-0.1$      | $\pm 1.5$  | mV                           | Gain = 2  |
| Full-Scale Error                      |        | $-0.018$    | $\pm 0.14$ | % of FSR                     | Gain = 1  |
|                                       |        | $-0.013$    | $\pm 0.07$ | % of FSR                     | Gain = 2, $V_{DD} = 5.5\text{ V}$   |
| Gain Error                            |        | $+0.04$     | $\pm 0.12$ | % of FSR                     | Gain = 1  |
|                                       |        | $-0.02$     | $\pm 0.06$ | % of FSR                     | Gain = 2  |
| TUE                                   |        | $\pm 0.03$  | $\pm 0.18$ | % of FSR                     | Gain = 1  |
|                                       |        | $\pm 0.006$ | $\pm 0.14$ | % of FSR                     | Gain = 2  |
| Offset Error Drift                    |        | $\pm 2$     |            | $\mu\text{V}/^\circ\text{C}$ | Gain = 1  |
| DC PSRR                               |        | 0.25        |            | mV/V                         | DAC code = midscale, $V_{DD} = 5\text{ V} \pm 10\%$   |
| DC Crosstalk                          |        | $\pm 2$     |            | $\mu\text{V}$                | Due to single channel, full-scale output change, internal reference, gain = 1                         |
|                                       |        | $\pm 3$     |            | $\mu\text{V}/\text{mA}$      | Due to load current change, external reference, gain = 2  |
|                                       |        | $\pm 2$     |            | $\mu\text{V}$                | Due to powering down (per channel), internal reference, gain = 1                                      |
| <b>OUTPUT CHARACTERISTICS</b>         |        |             |            |                              |   |
| Output Power-Up Voltage               |        | 0           |            | V                            | Gain = 1, AD5677R-1   |
|                                       |        | 0           |            | V                            | Gain = 2, AD5677R-1   |
|                                       |        | 1.25        |            | V                            | Gain = 1, AD5677R-2   |
|                                       |        | 2.5         |            | V                            | Gain = 2, AD5677R-2   |
| Output Voltage Range                  | 0      |             | 2.5        | V                            | Gain = 1  |
|                                       | 0      |             | 5          | V                            | Gain = 2  |
| Capacitive Load Stability             |        | 2           |            | nF                           | $R_L = \infty$  |
|                                       |        | 10          |            | nF                           | $R_L = 1\text{ k}\Omega$  |
| Load Regulation                       |        | 183         |            | $\mu\text{V}/\text{mA}$      | $V_{DD} = 5\text{ V} \pm 10\%$ , DAC code = midscale, $-30\text{ mA} \leq I_{OUT} \leq +30\text{ mA}$ |
|                                       |        | 177         |            | $\mu\text{V}/\text{mA}$      | $V_{DD} = 3\text{ V} \pm 10\%$ , DAC code = midscale, $-20\text{ mA} \leq I_{OUT} \leq +20\text{ mA}$ |
| Short-Circuit Current <sup>2</sup>    |        | 40          |            | mA                           |   |
| Load Impedance at Rails <sup>3</sup>  |        | 25          |            | $\Omega$                     |   |
| Power-Up Time                         |        | 3           |            | $\mu\text{s}$                | Exiting power-down mode, $V_{DD} = 5\text{ V}$  |
| <b>REFERENCE INPUT</b>                |        |             |            |                              |   |
| Reference Input Current               |        | 0.8         |            | mA                           | $V_{REF} = V_{DD} = V_{LOGIC} = 5.5\text{ V}$ , gain = 1  |
|                                       |        | 1.6         |            | mA                           | $V_{REF} = V_{DD} = V_{LOGIC} = 5.5\text{ V}$ , gain = 2  |
| Reference Input Range                 | 1      |             | $V_{DD}$   | V                            | Gain = 1  |
|                                       | 1      |             | $V_{DD}/2$ | V                            | Gain = 2  |
| Reference Input Impedance             |        | 7           |            | k $\Omega$                   | Gain = 1  |
|                                       |        | 3.5         |            | k $\Omega$                   | Gain = 2  |
| <b>REFERENCE OUTPUT</b>               |        |             |            |                              |   |
| Output Voltage <sup>4</sup>           | 2.4975 |             | 2.5025     | V                            |   |
| Voltage Reference TC <sup>5,6</sup>   |        | 2           | 5          | ppm/ $^\circ\text{C}$        | See voltage reference temperature coefficient (TC) in the Terminology section                         |
| Output Impedance                      |        | 0.04        |            | $\Omega$                     |   |
| Output Voltage Noise                  |        | 13          |            | $\mu\text{V p-p}$            | 0.1 Hz to 10 Hz   |

| Parameter                         | Min                    | Typ      | Max                     | Unit                    | Test Conditions/Comments  |
|-----------------------------------|------------------------|----------|-------------------------|-------------------------|---|
| Output Voltage Noise Density      |                        | 240      |                         | nV/ $\sqrt{\text{Hz}}$  | At $T_A$ , $f = 10 \text{ kHz}$ , $C_L = 10 \text{ nF}$ , gain = 1 or 2                 |
| Load Regulation Sourcing          |                        | 29       |                         | $\mu\text{V}/\text{mA}$ | $T_A$   |
| Load Regulation Sinking           |                        | 74       |                         | $\mu\text{V}/\text{mA}$ | $T_A$   |
| Output Current Load Capability    |                        | $\pm 20$ |                         | mA                      | $V_{DD} \geq 3 \text{ V}$   |
| Line Regulation                   |                        | 43       |                         | $\mu\text{V}/\text{V}$  | $T_A$   |
| Long-Term Stability Drift         |                        | 77       |                         | ppm                     | After 1000 hours at $25^\circ\text{C}$  |
| Thermal Hysteresis                |                        | 125      |                         | ppm                     | First cycle   |
|                                   |                        | 25       |                         | ppm                     | Additional cycles   |
| <b>LOGIC INPUTS</b>               |                        |          |                         |                         |   |
| Input Current                     |                        |          | $\pm 1$                 | $\mu\text{A}$           | Per pin   |
| Input Voltage<br>Low, $V_{INL}$   |                        |          | $0.3 \times V_{LOGIC}$  | V                       | $1.62 \text{ V} \leq V_{LOGIC} \leq 3.3 \text{ V}$                                      |
| High, $V_{INH}$                   | $0.7 \times V_{LOGIC}$ |          | $0.25 \times V_{LOGIC}$ | V                       | $3.3 \text{ V} \leq V_{LOGIC} \leq 5.5 \text{ V}$                                       |
| Pin Capacitance                   |                        | 4        |                         | pF                      |   |
| <b>LOGIC OUTPUTS (SDA)</b>        |                        |          |                         |                         |   |
| Output Voltage<br>Low, $V_{OL}$   |                        |          | 0.4                     | V                       | $I_{OL} = 3 \text{ mA}$   |
| High, $V_{OH}$                    | $V_{LOGIC} - 0.4$      |          |                         | V                       | $I_{OH} = -3 \text{ mA}$  |
| Floating State Output Capacitance |                        | 9        |                         | pF                      |   |
| <b>POWER REQUIREMENTS</b>         |                        |          |                         |                         |   |
| $V_{LOGIC}$                       | 1.62                   |          | 5.5                     | V                       | 1.8 V logic compatibility   |
| $I_{LOGIC}$                       |                        |          | 3                       | $\mu\text{A}$           | Power-on, $-40^\circ\text{C}$ to $+105^\circ\text{C}$                                   |
|                                   |                        |          | 3                       | $\mu\text{A}$           | Power-on, $-40^\circ\text{C}$ to $+125^\circ\text{C}$                                   |
|                                   |                        |          | 3                       | $\mu\text{A}$           | Power-down, $-40^\circ\text{C}$ to $+105^\circ\text{C}$                                 |
|                                   |                        |          | 3                       | $\mu\text{A}$           | Power-down, $-40^\circ\text{C}$ to $+125^\circ\text{C}$                                 |
| $V_{DD}$                          | 2.7                    |          | 5.5                     | V                       | Gain = 1  |
|                                   | $V_{REF} + 1.5$        |          | 5.5                     | V                       | Gain = 2  |
| $I_{DD}$                          |                        |          |                         |                         | $V_{IH} = V_{DD}$ , $V_{IL} = \text{GND}$ , $V_{DD} = 2.7 \text{ V}$ to $5.5 \text{ V}$ |
| Normal Mode <sup>7</sup>          |                        | 2.3      | 2.53                    | mA                      | Internal reference off, $-40^\circ\text{C}$ to $+85^\circ\text{C}$                      |
|                                   |                        | 3.4      | 3.8                     | mA                      | Internal reference on, $-40^\circ\text{C}$ to $+85^\circ\text{C}$                       |
|                                   |                        | 2.3      | 2.6                     | mA                      | Internal reference off  |
|                                   |                        | 3.4      | 4.2                     | mA                      | Internal reference on   |
| All Power-Down Modes <sup>8</sup> |                        | 2        | 3.4                     | $\mu\text{A}$           | Power-down to $1 \text{ k}\Omega$ , $-40^\circ\text{C}$ to $+85^\circ\text{C}$          |
|                                   |                        | 2        | 5                       | $\mu\text{A}$           | Power-down to $1 \text{ k}\Omega$ , $-40^\circ\text{C}$ to $+105^\circ\text{C}$         |
|                                   |                        | 2        | 11                      | $\mu\text{A}$           | Power-down to $1 \text{ k}\Omega$ , $-40^\circ\text{C}$ to $+125^\circ\text{C}$         |

<sup>1</sup> DC specifications tested with the outputs unloaded, unless otherwise noted. Upper dead band = 10 mV and exists only when  $V_{REF} = V_{DD}$  with gain = 1, or when  $V_{REF}/2 = V_{DD}$  with gain = 2. Linearity calculated using a reduced code range of 256 to 65,280.

<sup>2</sup>  $V_{DD} = 5 \text{ V}$ . The device includes current limiting intended to protect the devices during temporary overload conditions.  $T_J$  can be exceeded during current limit.

Operation above the specified maximum operation junction temperature can impair device reliability.

<sup>3</sup> When drawing a load current at either rail, the output voltage headroom with respect to that rail is limited by the  $25 \Omega$  typical channel resistance of the output devices. For example, when sinking 1 mA, the minimum output voltage =  $25 \Omega \times 1 \text{ mA} = 25 \text{ mV}$ .

<sup>4</sup> Initial accuracy presolder reflow is  $\pm 750 \mu\text{V}$ . Output voltage includes the effects of preconditioning drift. See the Internal Reference Setup section.

<sup>5</sup> Reference is trimmed and tested at two temperatures and is characterized from  $-40^\circ\text{C}$  to  $+125^\circ\text{C}$ .

<sup>6</sup> Voltage reference temperature coefficient is calculated as per the box method. See the voltage reference temperature coefficient (TC) definition in the Terminology section for further information.

<sup>7</sup> Interface inactive. All DACs active. DAC outputs unloaded.

<sup>8</sup> All DACs powered down.

**AC CHARACTERISTICS**

$V_{DD} = 2.7\text{ V to }5.5\text{ V}$ ,  $1.62\text{ V} \leq V_{LOGIC} \leq 5.5\text{ V}$ ,  $R_L = 2\text{ k}\Omega$  to GND,  $C_L = 200\text{ pF}$  to GND, all specifications are  $T_J = -40^\circ\text{C to }+125^\circ\text{C}$ , typical at  $T_A = 25^\circ\text{C}$ , unless otherwise noted.

**Table 4.**

| Parameter  | Min | Typ   | Max | Unit                         | Test Conditions/Comments  |
|--|-----|-------|-----|------------------------------|---|
| OUTPUT VOLTAGE SETTLING TIME <sup>1</sup>        | 6   | 8     |     | $\mu\text{s}$                | $\frac{1}{4}$ to $\frac{3}{4}$ scale settling to $\pm 2$ LSB  |
| SLEW RATE  |     | 0.8   |     | $\text{V}/\mu\text{s}$       |   |
| DIGITAL-TO-ANALOG GLITCH IMPULSE <sup>1</sup>    |     | 1.4   |     | $\text{nV}\cdot\text{sec}$   | 1 LSB change around major carry (internal reference, gain = 1)  |
| DIGITAL FEEDTHROUGH <sup>1</sup>                 |     | 0.13  |     | $\text{nV}\cdot\text{sec}$   |   |
| CROSSTALK <sup>1</sup>                           |     |       |     |                              |   |
| Digital  |     | 0.1   |     | $\text{nV}\cdot\text{sec}$   |   |
| Analog   |     | -0.25 |     | $\text{nV}\cdot\text{sec}$   | Internal reference, gain = 2  |
| DAC to DAC                                       |     | -1.3  |     | $\text{nV}\cdot\text{sec}$   | Internal reference, gain = 2  |
| DAC to DAC                                       |     | -2.0  |     | $\text{nV}\cdot\text{sec}$   | Internal reference, gain = 2  |
| TOTAL HARMONIC DISTORTION (THD) <sup>2</sup>     |     | -80   |     | dB                           | At $T_A$ , bandwidth = 20 kHz, $V_{DD} = 5\text{ V}$ , output frequency ( $f_{OUT}$ ) = 1 kHz, internal reference, gain = 2       |
| OUTPUT NOISE SPECTRAL DENSITY (NSD) <sup>1</sup> |     | 300   |     | $\text{nV}/\sqrt{\text{Hz}}$ | DAC code = midscale, 10 kHz, gain = 2   |
| OUTPUT NOISE                                     |     | 6     |     | $\mu\text{V p-p}$            | 0.1 Hz to 10 Hz, gain = 1   |
| SIGNAL-TO-NOISE RATIO (SNR)                      |     | 90    |     | dB                           | At $T_A = 25^\circ\text{C}$ , bandwidth = 20 kHz, $V_{DD} = 5\text{ V}$ , $f_{OUT} = 1\text{ kHz}$ , internal reference           |
| SPURIOUS-FREE DYNAMIC RANGE (SFDR)               |     | 83    |     | dB                           | At $T_A = 25^\circ\text{C}$ , bandwidth = 20 kHz, $V_{DD} = 5\text{ V}$ , $f_{OUT} = 1\text{ kHz}$ , internal reference           |
| SIGNAL-TO-NOISE-AND-DISTORTION RATIO (SINAD)     |     | 80    |     | dB                           | At $T_A = 25^\circ\text{C}$ , bandwidth = 20 kHz, $V_{DD} = 5\text{ V}$ , $f_{OUT} = 1\text{ kHz}$ , internal reference, gain = 2 |

<sup>1</sup> See the Terminology section. Measured using internal reference and gain = 1, unless otherwise noted.

<sup>2</sup> Digitally generated sine wave ( $f_{OUT}$ ) at 1 kHz.

**TIMING CHARACTERISTICS**

$V_{DD} = 2.7\text{ V to } 5.5\text{ V}$ ,  $1.62\text{ V} \leq V_{LOGIC} \leq 5.5\text{ V}$ , all specifications are  $T_J = -40^\circ\text{C to } +125^\circ\text{C}$ , unless otherwise noted. See Figure 2 and Figure 3.

Table 5.

| Parameter <sup>1</sup> | Min           | Typ | Max | Unit          | Description   |
|------------------------|---------------|-----|-----|---------------|---|
| $t_1$                  | 2.5           |     |     | $\mu\text{s}$ | SCL cycle time  |
| $t_2$                  | 0.6           |     |     | $\mu\text{s}$ | SCL high time   |
| $t_3$                  | 1.3           |     |     | $\mu\text{s}$ | SCL low time  |
| $t_4$                  | 0.6           |     |     | $\mu\text{s}$ | Start or repeated start hold time   |
| $t_5$                  | 100           |     |     | ns            | Data setup time   |
| $t_6^2$                | 0             |     | 0.9 | $\mu\text{s}$ | Data hold time  |
| $t_7$                  | 0.6           |     |     | $\mu\text{s}$ | Repeated start setup time   |
| $t_8$                  | 0.6           |     |     | $\mu\text{s}$ | Stop condition setup time   |
| $t_9$                  | 1.3           |     |     | $\mu\text{s}$ | Bus free time between a stop condition and a start condition                    |
| $t_{10}^3$             | $20 + 0.1C_B$ |     | 300 | ns            | Rise time of SCL and SDA when receiving   |
| $t_{11}^{3,4}$         | $20 + 0.1C_B$ |     | 300 | ns            | Fall time of SCL and SDA when transmitting or receiving                         |
| $t_{12}$               | 20            |     |     | ns            | LDAC pulse width  |
| $t_{13}$               | 400           |     |     | ns            | SCL rising edge to LDAC rising edge   |
| $t_{14}$               | 8             |     |     | ns            | RESET minimum pulse width low, $1.62\text{ V} \leq V_{LOGIC} \leq 2.7\text{ V}$ |
|                        | 10            |     |     | ns            | RESET minimum pulse width low, $2.7\text{ V} \leq V_{LOGIC} \leq 5.5\text{ V}$  |
| $t_{15}$               | 115           |     |     | ns            | RESET activation time, $1.62\text{ V} \leq V_{LOGIC} \leq 2.7\text{ V}$         |
|                        | 115           |     |     | ns            | RESET activation time, $2.7\text{ V} \leq V_{LOGIC} \leq 5.5\text{ V}$          |
| $t_{sp}^5$             | 0             |     | 50  | ns            | Pulse width of suppressed spike   |
| $C_B^4$                |               |     | 400 | pF            | Capacitive load for each bus line   |
| Update Rate            |               |     | 400 | kHz           | Fast mode   |
|                        |               |     | 100 | kHz           | Standard mode   |

<sup>1</sup> See Figure 2.

<sup>2</sup> A master device must provide a hold time of at least 300 ns for the SDA signal (referred to the minimum  $V_{IH}$  of the SCL signal) to bridge the undefined region of the SCL falling edge.

<sup>3</sup>  $t_{10}$  (rise time) and  $t_{11}$  (fall time) are measured from  $0.3 \times V_{DD}$  to  $0.7 \times V_{DD}$ .

<sup>4</sup>  $C_B$  is the total capacitance of one bus line in pF.

<sup>5</sup> Input filtering on the SCL and SDA inputs suppresses noise spikes that are less than 50 ns. Not shown in Figure 2 or Figure 3.

**Timing Diagrams**

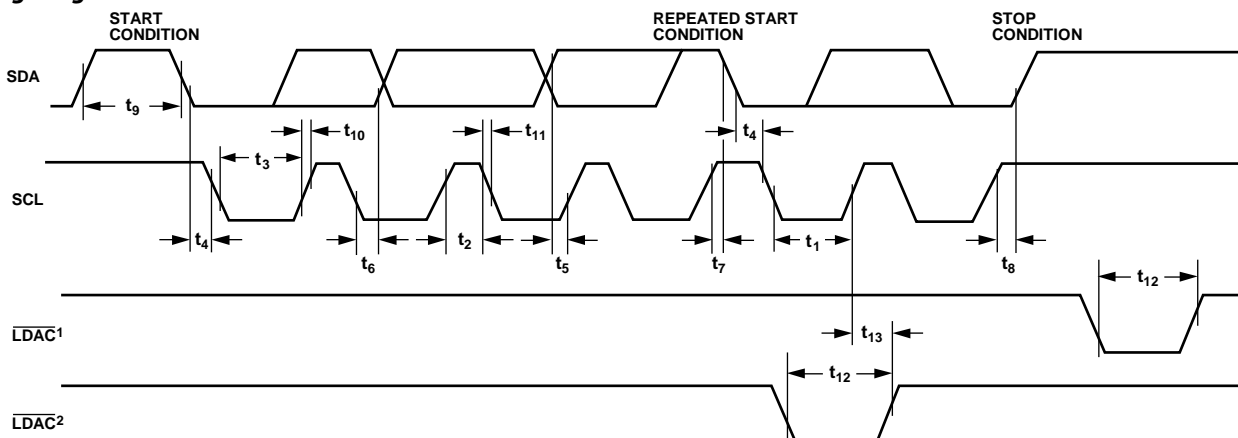

NOTES

<sup>1</sup>ASYNCHRONOUS LDAC UPDATE MODE.

<sup>2</sup>SYNCHRONOUS LDAC UPDATE MODE.

Figure 2. 2-Wire Serial Interface Timing Diagram

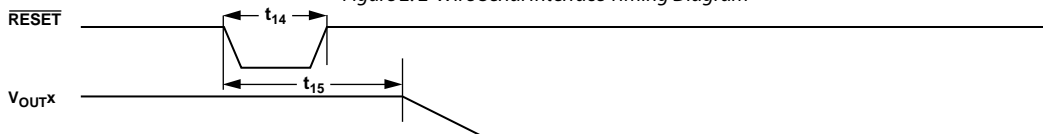

Figure 3. RESET Timing Diagram



## ABSOLUTE MAXIMUM RATINGS

$T_A = 25^\circ\text{C}$ , unless otherwise noted.

Table 6.

| Parameter   | Rating                        |
|---|-------------------------------|
| $V_{DD}$ to GND   | -0.3 V to +7 V                |
| $V_{LOGIC}$ to GND  | -0.3 V to +7 V                |
| $V_{OUTX}^1$ to GND                                       | -0.3 V to $V_{DD} + 0.3$ V    |
| $V_{REF}$ to GND  | -0.3 V to $V_{DD} + 0.3$ V    |
| Digital Input Voltage to GND                              | -0.3 V to $V_{LOGIC} + 0.3$ V |
| Operating Junction Temperature Range                      | -40°C to +125°C               |
| Storage Temperature Range                                 | -65°C to +150°C               |
| Absolute Maximum Junction Temperature                     | 150°C                         |
| Reflow Soldering Peak Temperature,<br>Pb Free (J-STD-020) | 260°C                         |

<sup>1</sup>  $V_{OUTX}$  is the voltage of the  $V_{OUTX}$  pins.

Stresses at or above those listed under Absolute Maximum Ratings may cause permanent damage to the product. This is a stress rating only; functional operation of the product at these or any other conditions above those indicated in the operational section of this specification is not implied. Operation beyond the maximum operating conditions for extended periods may affect product reliability.

## THERMAL RESISTANCE

Thermal performance is directly linked to printed circuit board (PCB) design and operating environment. Careful attention to PCB thermal design is required.

$\theta_{JA}$  is the natural convection junction to ambient thermal resistance measured in a one cubic foot, sealed enclosure.  $\theta_{JB}$  is the junction to board thermal resistance.  $\theta_{JC}$  is the junction to case thermal resistance.  $\Psi_{JT}$  is the junction to top thermal characterization parameter.  $\Psi_{JB}$  is the junction to board thermal characterization parameter.

Table 7. Thermal Resistance

| Package Type <sup>1</sup> | $\theta_{JA}$ | $\theta_{JB}$ | $\theta_{JC}$ | $\Psi_{JT}$ | $\Psi_{JB}$ | Unit |
|---------------------------|---------------|---------------|---------------|-------------|-------------|------|
| CP-28-9                   | 55.09         | 24.49         | 19.14         | 2.62        | 23.92       | °C/W |

<sup>1</sup> Thermal impedance simulated values are based on a JEDEC 2S2P thermal test board with nine thermal vias. See JEDEC JESD51.

## ESD CAUTION



### ESD (electrostatic discharge) sensitive device.

Charged devices and circuit boards can discharge without detection. Although this product features patented or proprietary protection circuitry, damage may occur on devices subjected to high energy ESD. Therefore, proper ESD precautions should be taken to avoid performance degradation or loss of functionality.

## PIN CONFIGURATION AND FUNCTION DESCRIPTIONS

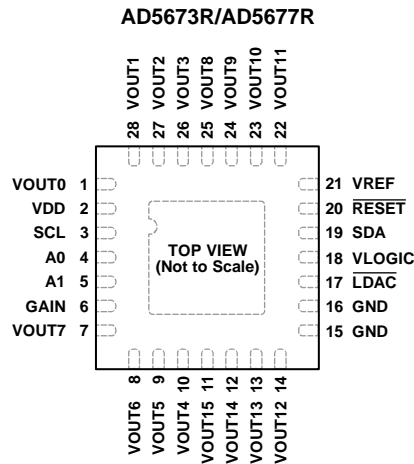

NOTES  
1. EXPOSED PAD. THE EXPOSED PAD MUST BE TIED TO GND.

22982-006

Figure 4. Pin Configuration Diagram

Table 8. Pin Function Descriptions

| Pin No. | Mnemonic | Description   |
|---------|----------|---|
| 1       | VOUT0    | Analog Output Voltage from DAC 0. The output amplifier has rail-to-rail operation.  |
| 2       | VDD      | Power Supply Input. These devices operate from 2.7 V to 5.5 V. Decouple the VDD supply with a 10 $\mu$ F capacitor in parallel with a 0.1 $\mu$ F capacitor to GND.   |
| 3       | SCL      | Serial Clock Line. In conjunction with the SDA line, the SCL pin clocks data into or out of the 24-bit input shift register.  |
| 4       | A0       | Address Input. Sets the first LSB of the 7-bit slave address.   |
| 5       | A1       | Address Input. Sets the second LSB of the 7-bit slave address.  |
| 6       | GAIN     | Span Set. When the GAIN pin is tied to GND, all 16 DAC outputs have a span from 0 V to $V_{REF}$ . If the GAIN pin is tied to VLOGIC, all 16 DACs output a span of 0 V to $2 \times V_{REF}$ .  |
| 7       | VOUT7    | Analog Output Voltage from DAC 7. The output amplifier has rail-to-rail operation.  |
| 8       | VOUT6    | Analog Output Voltage from DAC 6. The output amplifier has rail-to-rail operation.  |
| 9       | VOUT5    | Analog Output Voltage from DAC 5. The output amplifier has rail-to-rail operation.  |
| 10      | VOUT4    | Analog Output Voltage from DAC 4. The output amplifier has rail-to-rail operation.  |
| 11      | VOUT15   | Analog Output Voltage from DAC 15. The output amplifier has rail-to-rail operation.   |
| 12      | VOUT14   | Analog Output Voltage from DAC 14. The output amplifier has rail-to-rail operation.   |
| 13      | VOUT13   | Analog Output Voltage from DAC 13. The output amplifier has rail-to-rail operation.   |
| 14      | VOUT12   | Analog Output Voltage from DAC 12. The output amplifier has rail-to-rail operation.   |
| 15, 16  | GND      | Ground Reference Point for All Circuitry on the Device.   |
| 17      | LDAC     | Load DAC. LDAC operates in two modes, asynchronously and synchronously. Pulsing Pin 17 low updates any or all DAC registers when the input registers have new data, which simultaneously updates all DAC outputs. Pin 17 can also be tied permanently low.    |
| 18      | VLOGIC   | Digital Power Supply. The voltage on Pin 18 is specified in Table 2 and Table 3 within the power requirements parameter section.  |
| 19      | SDA      | Serial Data Input. In conjunction with the SCL line, Pin 19 clocks data into or out of the 24-bit input shift register. SDA is a bidirectional, open-drain data line that must be pulled to the supply with an external pull-up resistor.                     |
| 20      | RESET    | Asynchronous Reset Input. The RESET input is falling edge sensitive. When RESET is low, all LDAC pulses are ignored. When RESET is activated, the input register and the DAC register are updated with zero scale or midscale, depending on the model in use. |
| 21      | VREF     | Reference Output Voltage. When using the internal reference, VREF is the reference output pin. Pin 21 is the reference output by default.   |
| 22      | VOUT11   | Analog Output Voltage from DAC 11. The output amplifier has rail-to-rail operation.   |
| 23      | VOUT10   | Analog Output Voltage from DAC 10. The output amplifier has rail-to-rail operation.   |
| 24      | VOUT9    | Analog Output Voltage from DAC 9. The output amplifier has rail-to-rail operation.  |
| 25      | VOUT8    | Analog Output Voltage from DAC 8. The output amplifier has rail-to-rail operation.  |

| Pin No. | Mnemonic | Description  |
|---------|----------|--|
| 26      | VOUT3    | Analog Output Voltage from DAC 3. The output amplifier has rail-to-rail operation. |
| 27      | VOUT2    | Analog Output Voltage from DAC 2. The output amplifier has rail-to-rail operation. |
| 28      | VOUT1    | Analog Output Voltage from DAC 1. The output amplifier has rail-to-rail operation. |
|         | EPAD     | Exposed Pad. The exposed pad must be tied to GND.                                  |

TYPICAL PERFORMANCE CHARACTERISTICS

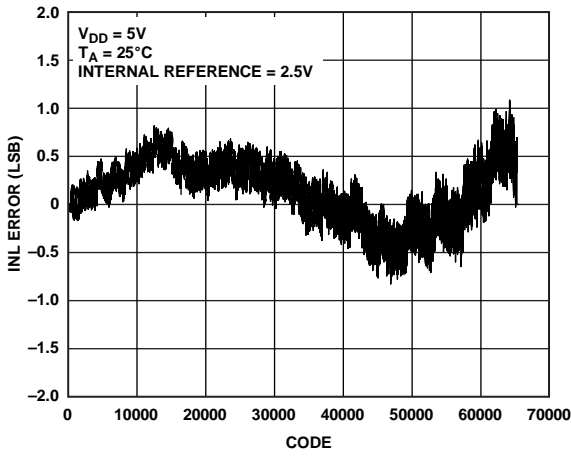

Figure 5. AD5677R INL Error vs. Code

22862-007

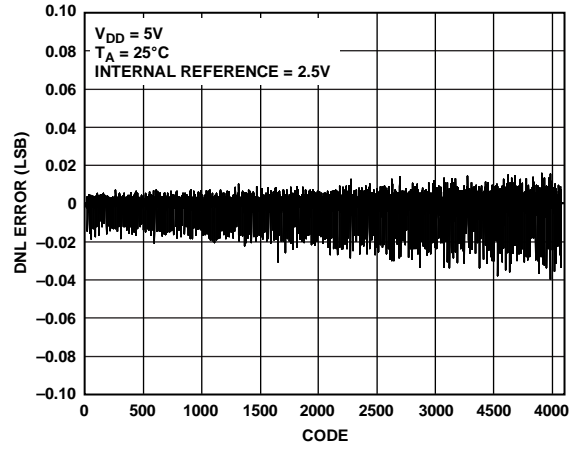

Figure 8. AD5673R DNL Error vs. Code

17326-302

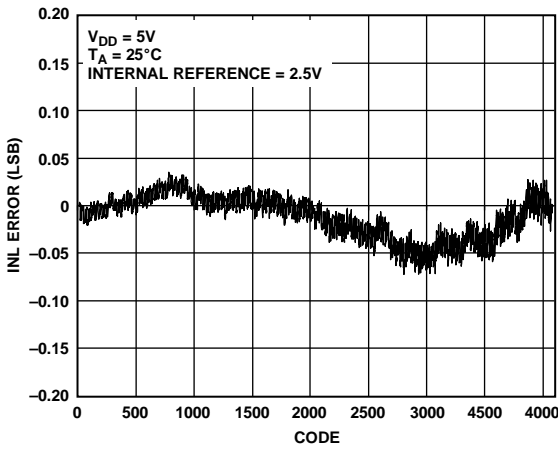

Figure 6. AD5673R INL Error vs. Code

22862-301

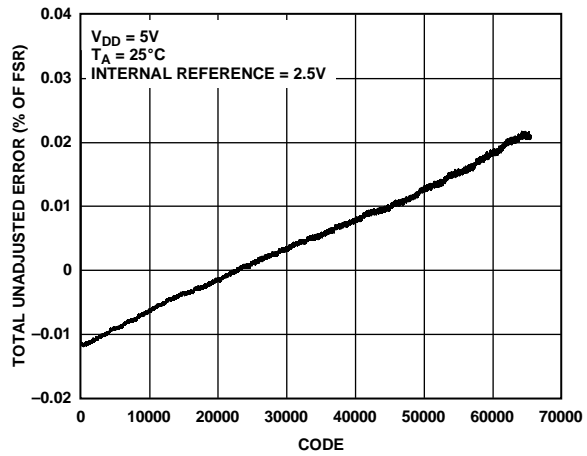

Figure 9. AD5677R Total Unadjusted Error vs. Code

22862-009

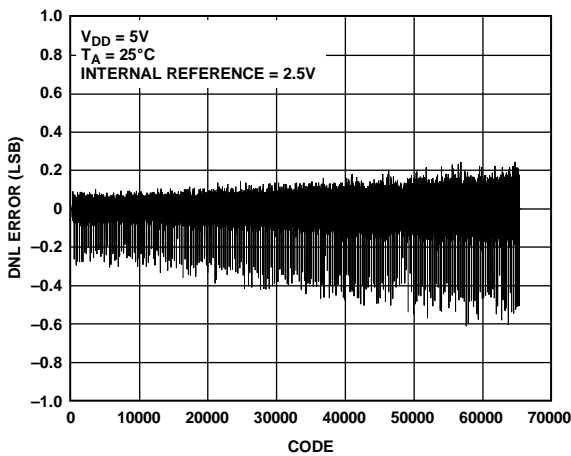

Figure 7. AD5677R DNL Error vs. Code

22862-008

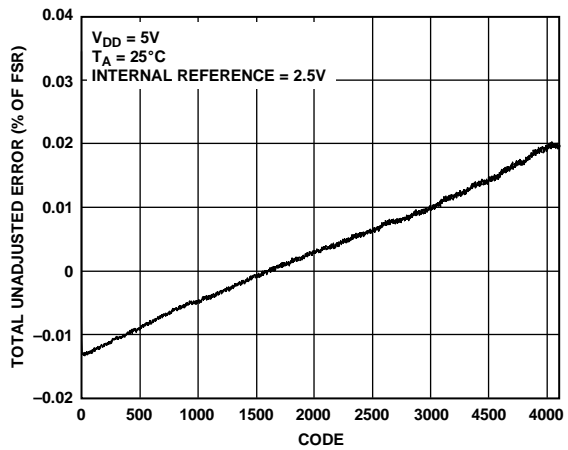

Figure 10. AD5673R Total Unadjusted Error vs. Code

22862-303

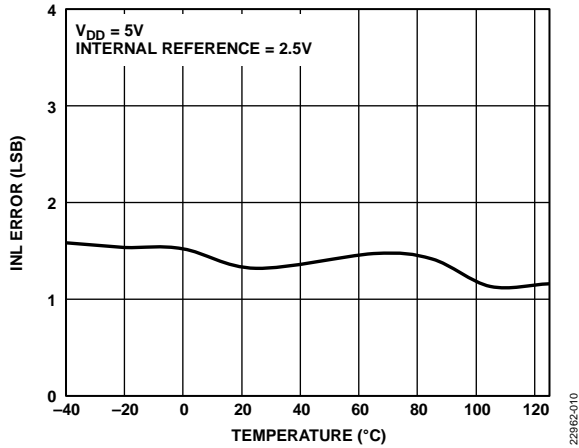

Figure 11. AD5677R INL Error vs. Temperature

22982-010

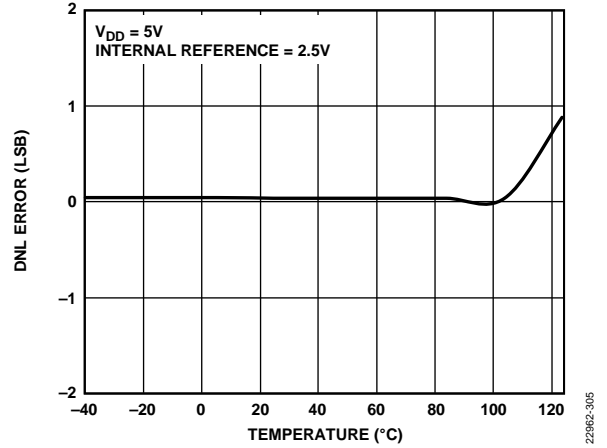

Figure 14. AD5673R DNL Error vs. Temperature

22982-305

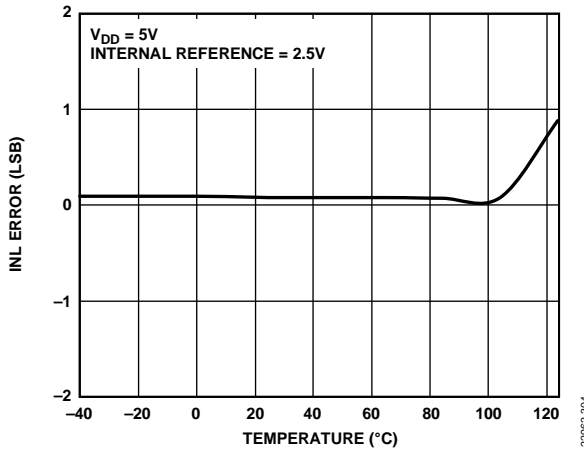

Figure 12. AD5673R INL Error vs. Temperature

22982-304

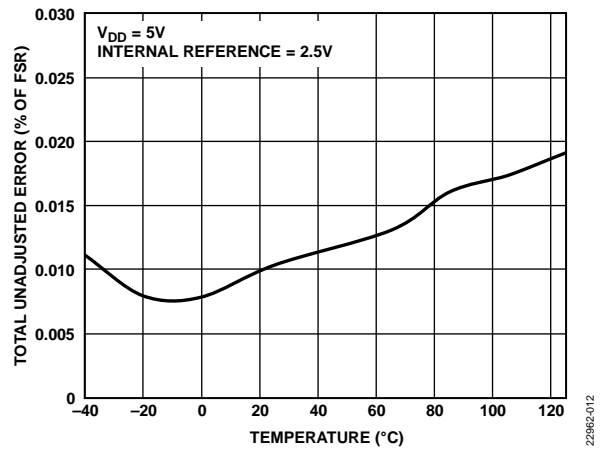

Figure 15. AD5677R Total Unadjusted Error vs. Temperature

22982-012

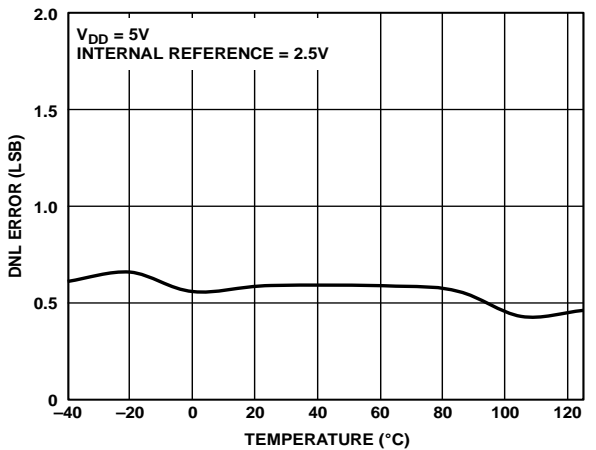

Figure 13. AD5677R DNL Error vs. Temperature

22982-011

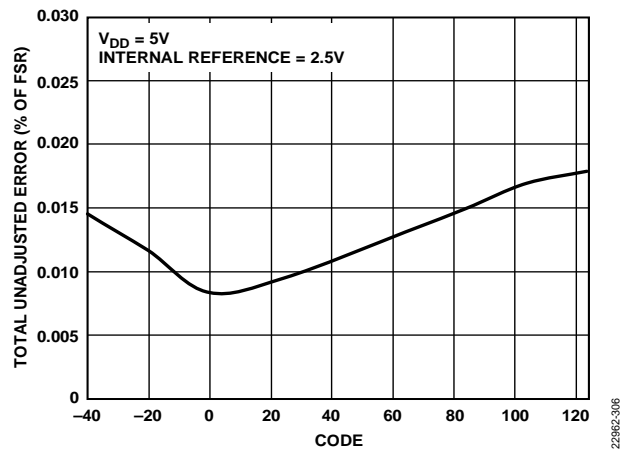

Figure 16. AD5673R Total Unadjusted Error vs. Temperature

22982-306

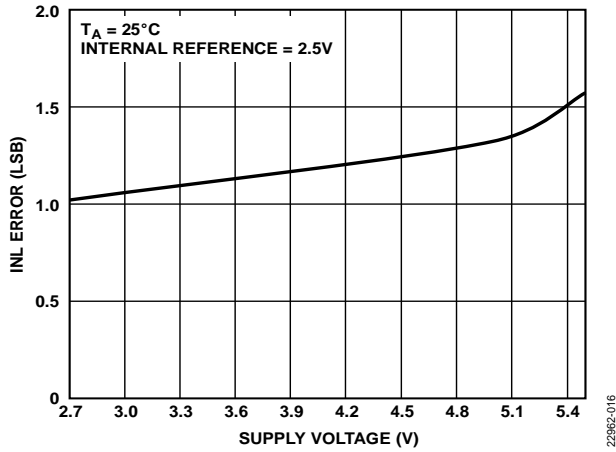

Figure 17. AD5677R INL Error vs. Supply Voltage

22982-016

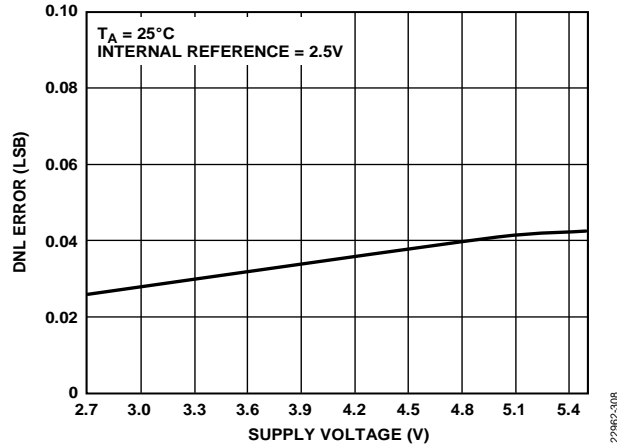

Figure 20. AD5673R DNL Error vs. Supply Voltage

22982-308

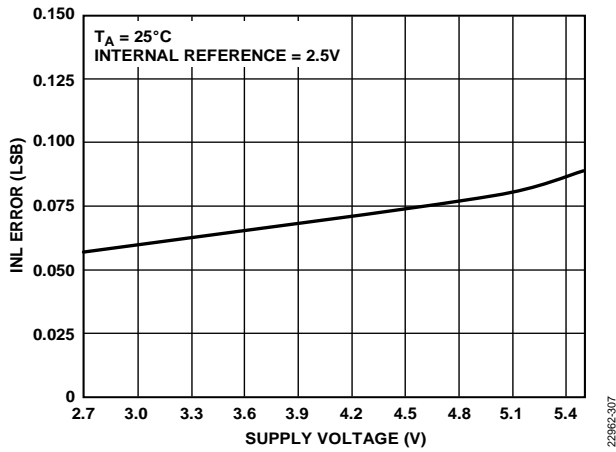

Figure 18. AD5673R INL Error vs. Supply Voltage

22982-307

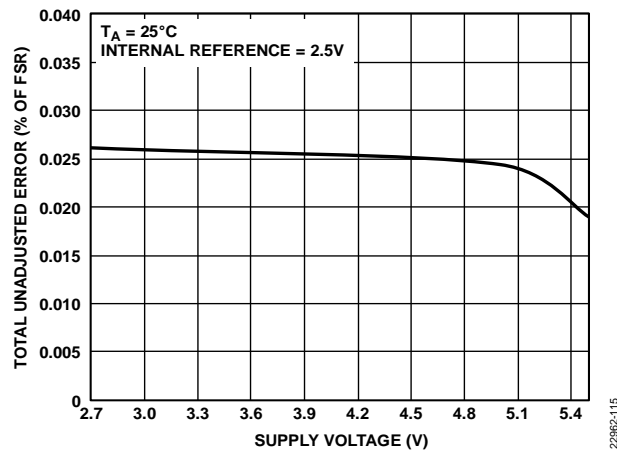

Figure 21. AD5677R Total Unadjusted Error vs. Supply Voltage

22982-115

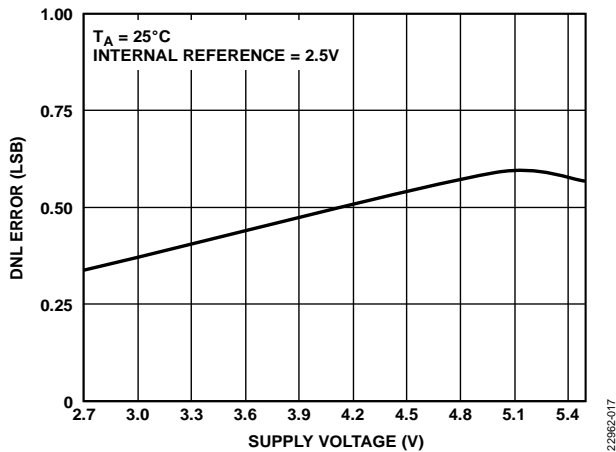

Figure 19. AD5677R DNL Error vs. Supply Voltage

22982-017

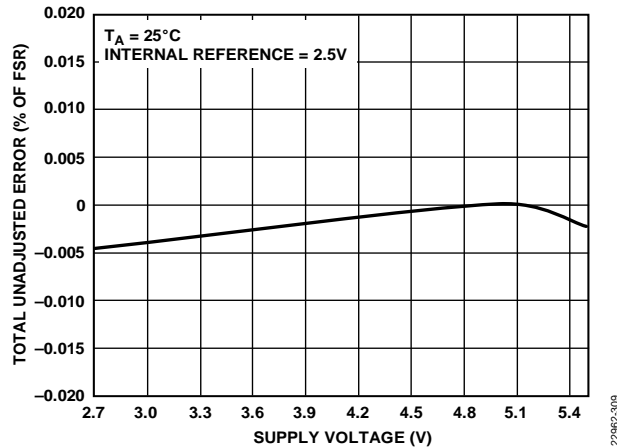

Figure 22. AD5673R Total Unadjusted Error vs. Supply Voltage

22982-309

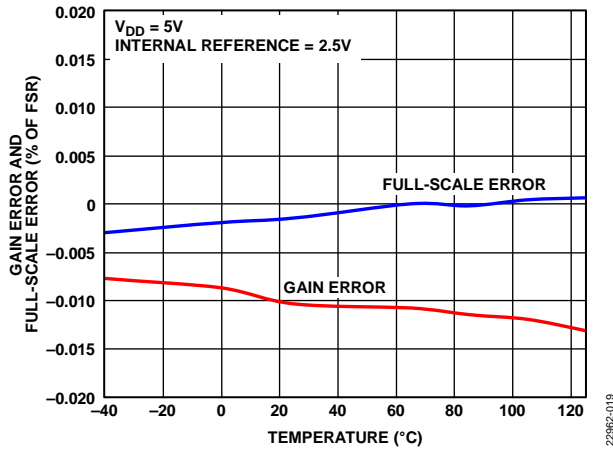

Figure 23. AD5677R Gain Error and Full-Scale Error vs. Temperature

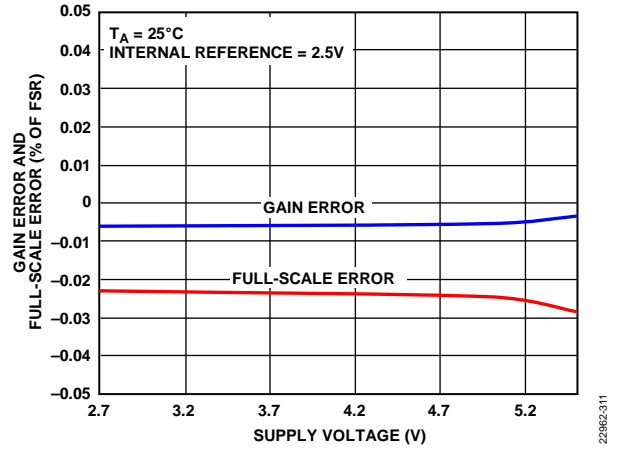

Figure 26. AD5673R Gain Error and Full-Scale Error vs. Supply Voltage

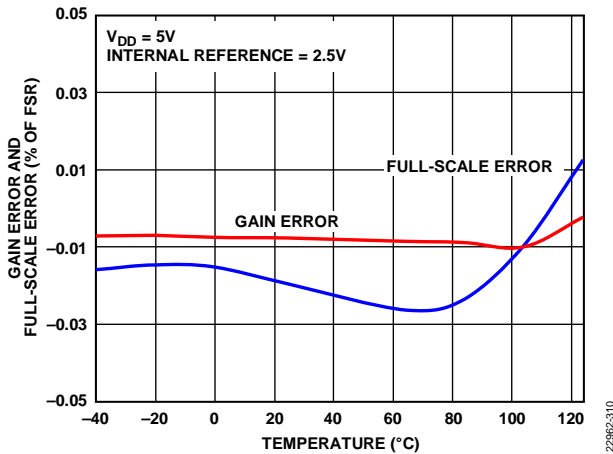

Figure 24. AD5673R Gain Error and Full-Scale Error vs. Temperature

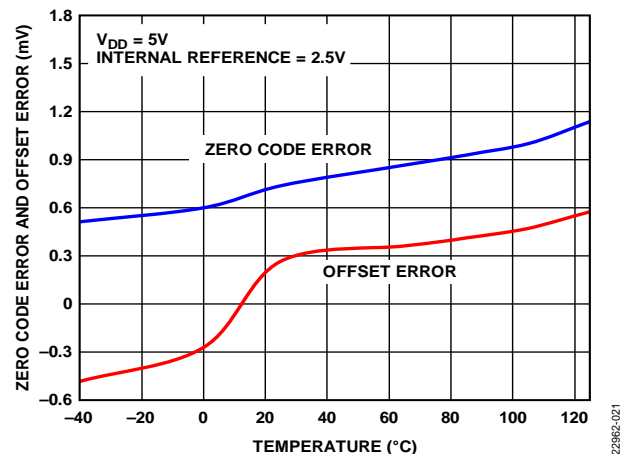

Figure 27. AD5677R Zero Code Error and Offset Error vs. Temperature

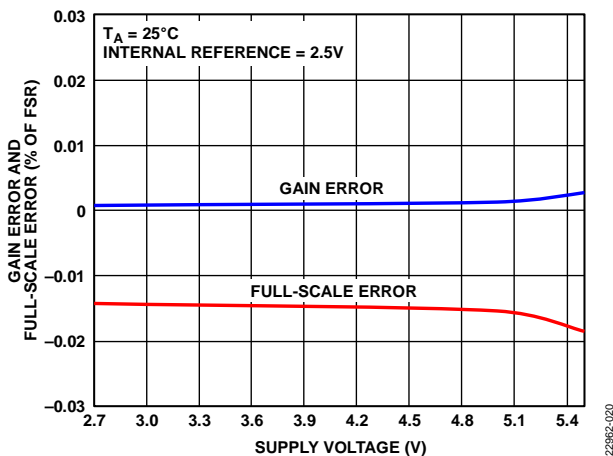

Figure 25. AD5677R Gain Error and Full-Scale Error vs. Supply Voltage

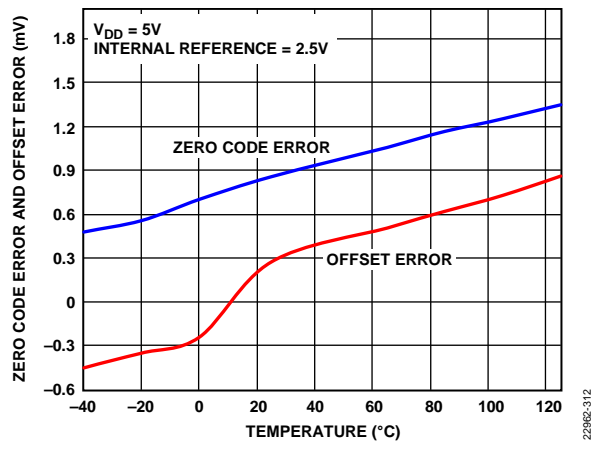

Figure 28. AD5673R Zero Code Error and Offset Error vs. Temperature

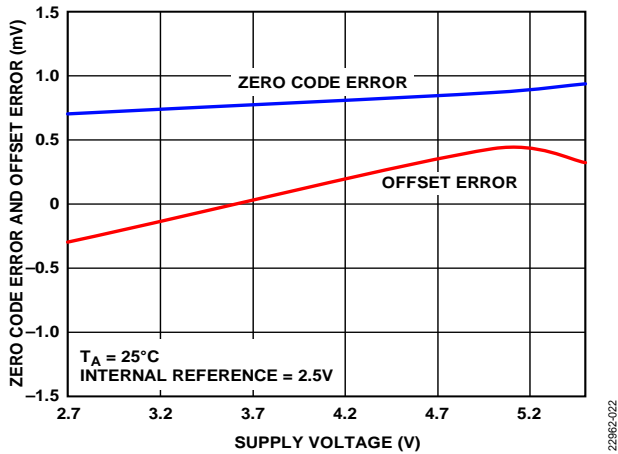

Figure 29. AD5677R Zero Code Error and Offset Error vs. Supply Voltage

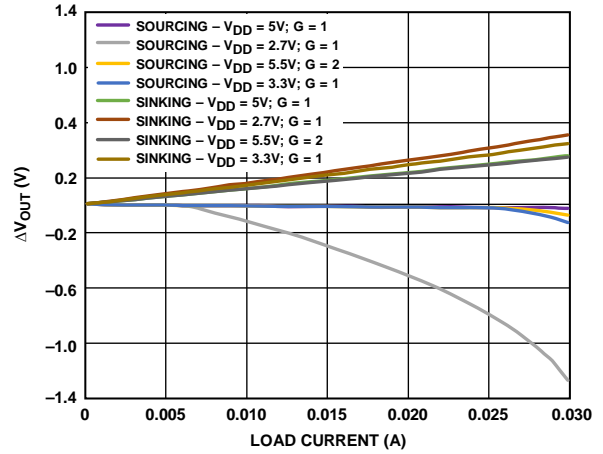

Figure 32. Headroom and Footroom ( $\Delta V_{out}$ ) vs. Load Current

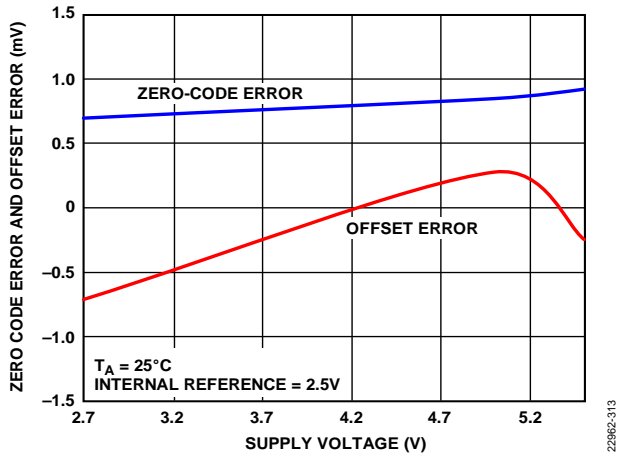

Figure 30. AD5673R Zero Code Error and Offset Error vs. Supply Voltage

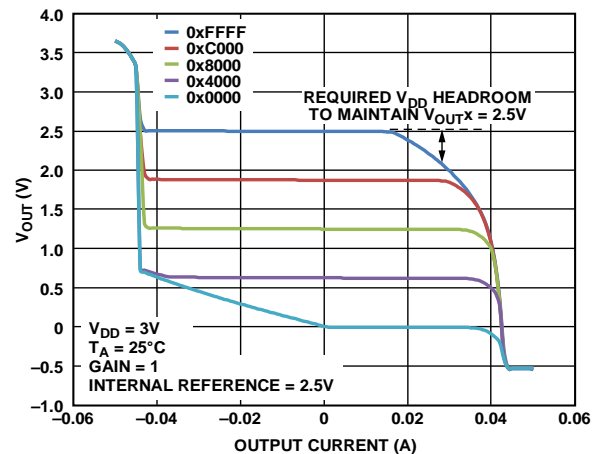

Figure 33. Source and Sink Capability at  $V_{DD} = 3V$

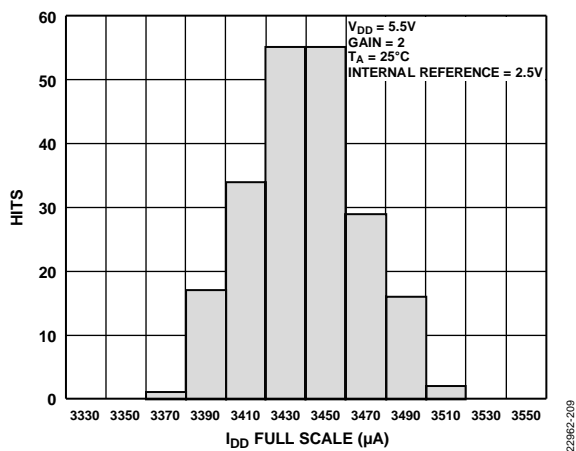

Figure 31. Supply Current ( $I_{DD}$ ) Histogram with Internal Reference

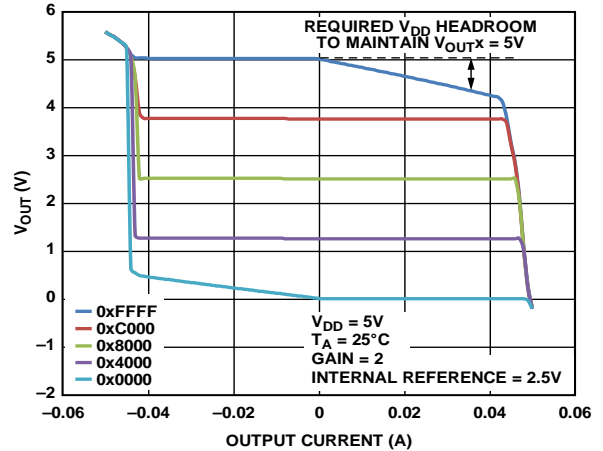

Figure 34. Source and Sink Capability at  $V_{DD} = 5V$



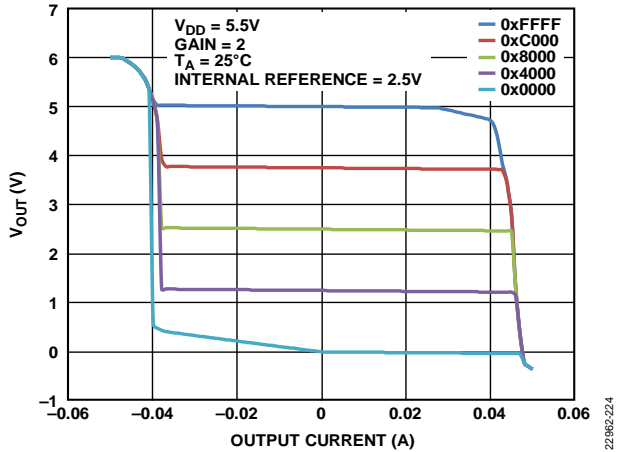

Figure 35. Source and Sink Capability at  $V_{DD} = 5.5\text{V}$

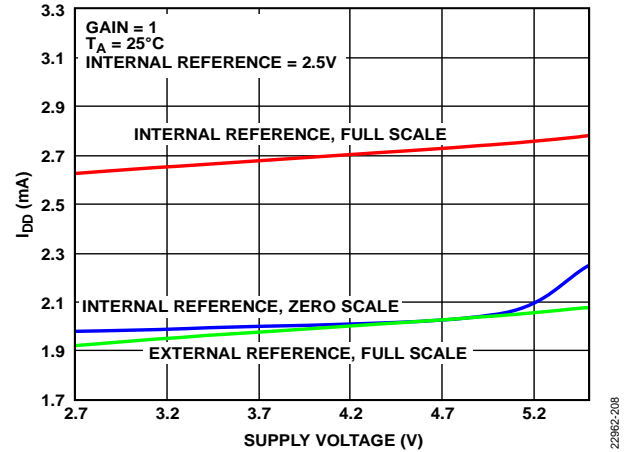

Figure 38.  $I_{DD}$  vs. Supply Voltage

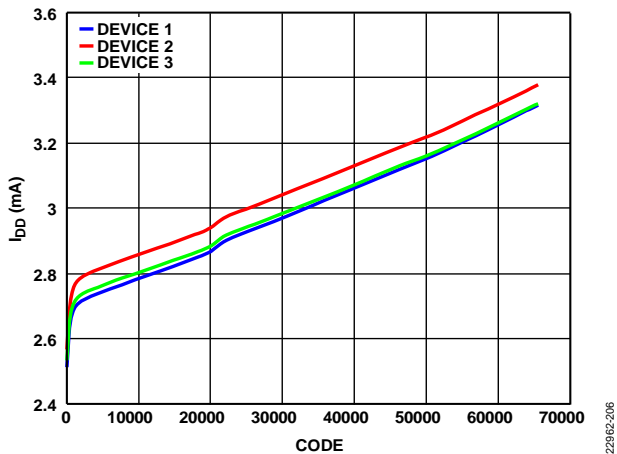

Figure 36.  $I_{DD}$  vs. Code

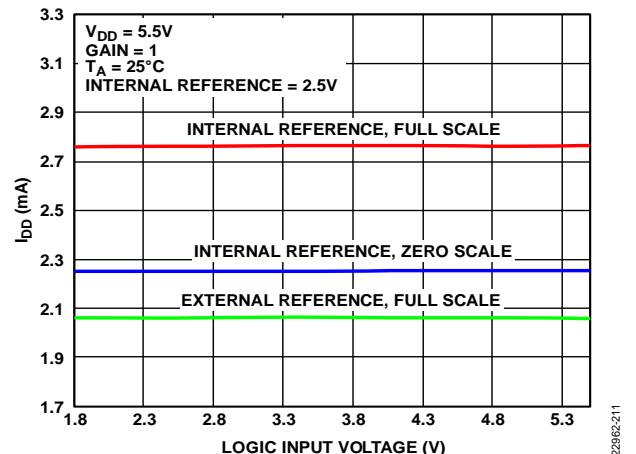

Figure 39.  $I_{DD}$  vs. Logic Input Voltage

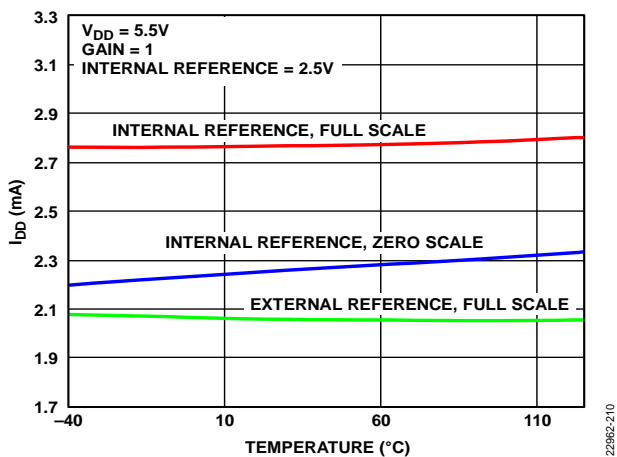

Figure 37.  $I_{DD}$  vs. Temperature

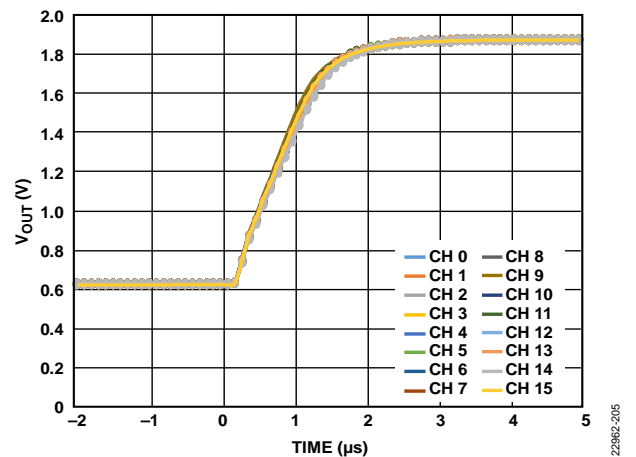

Figure 40. Settling Time

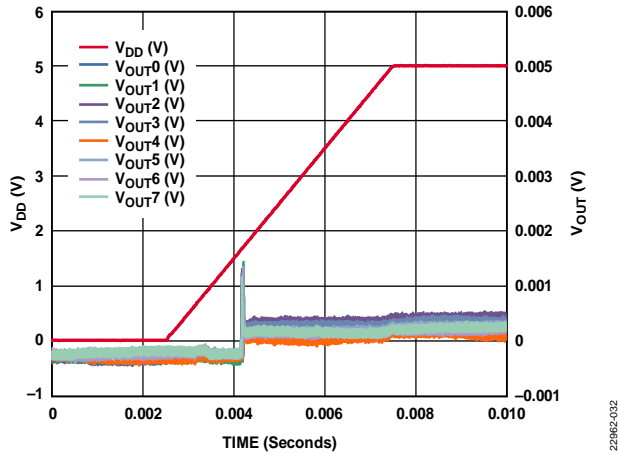

Figure 41. POR to 0 V Output

229862-032

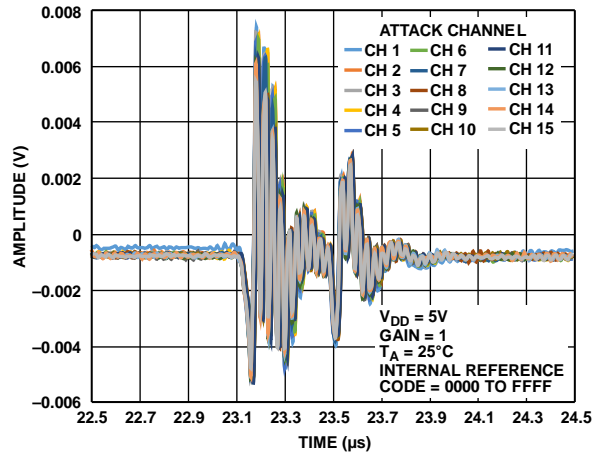

Figure 44. Analog Crosstalk

229862-201

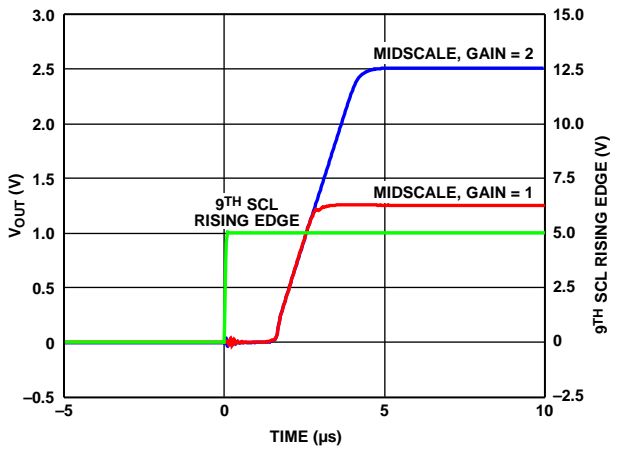

Figure 42. Exiting Power-Down to Midscale

229862-033

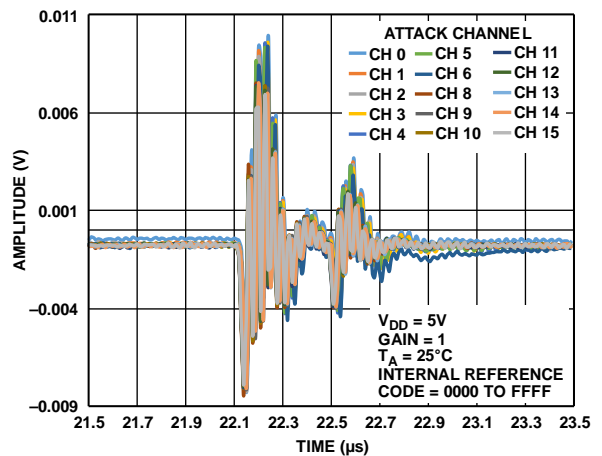

Figure 45. DAC to DAC Crosstalk

229862-202

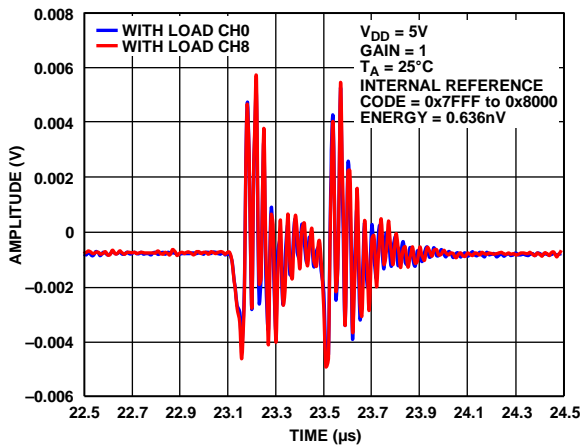

Figure 43. Digital-to-Analog Glitch Impulse

229862-203

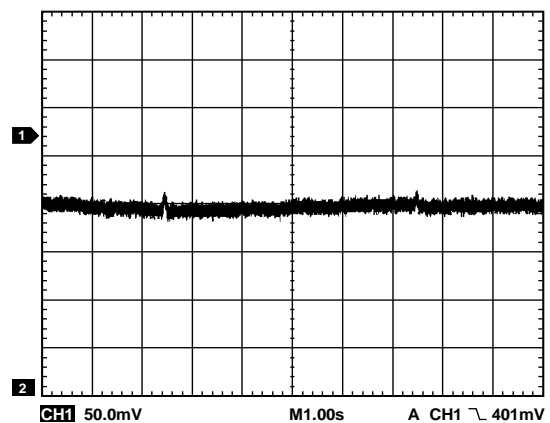

Figure 46. 0.1 Hz to 10 Hz Output Noise

229862-134

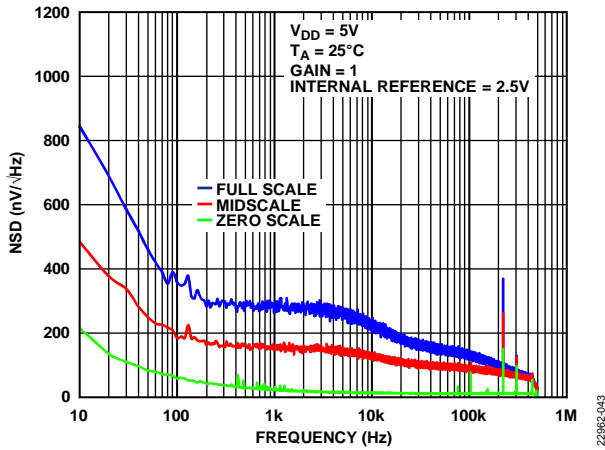

Figure 47. NSD

22982-043

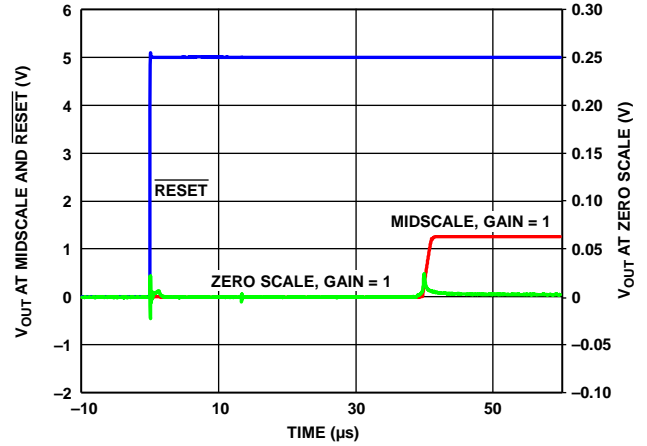

Figure 50. Hardware Reset

22982-042

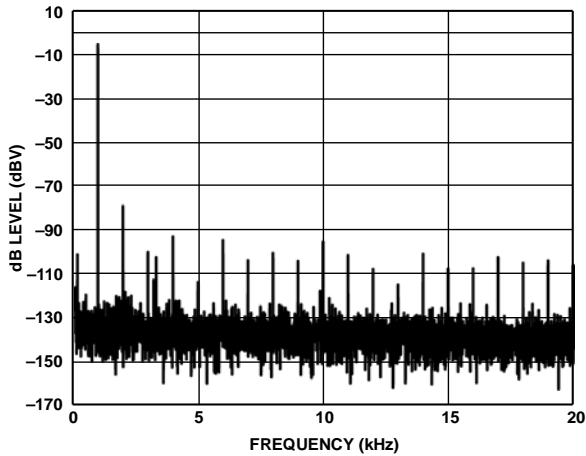

Figure 48. THD at 1 kHz

22982-204

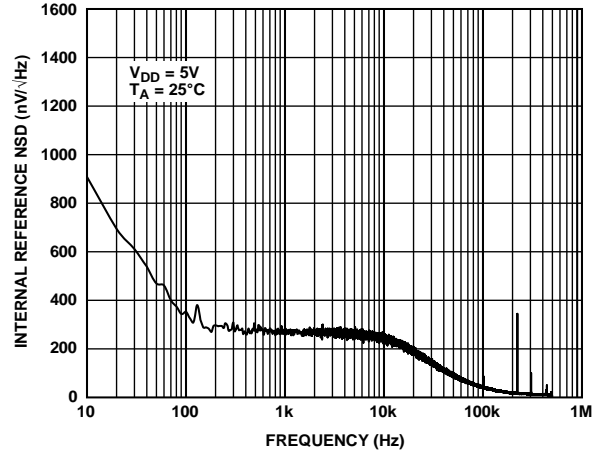

Figure 51. Internal Reference NSD vs. Frequency

22982-140

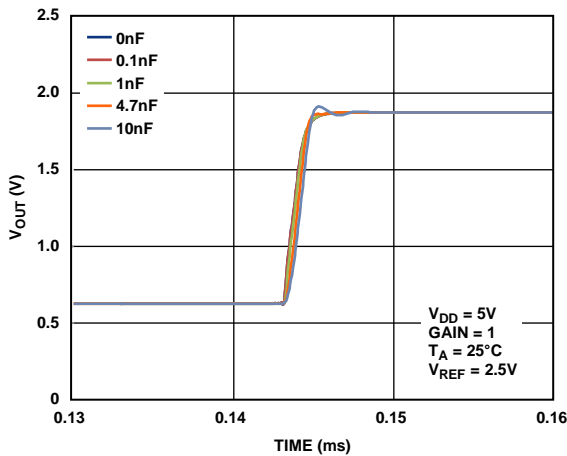

Figure 49. Settling Time at Various Capacitive Loads

22982-039

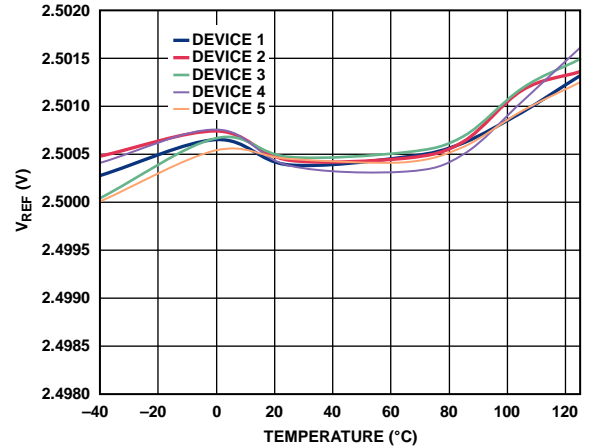

Figure 52.  $V_{REF}$  vs. Temperature

22982-142

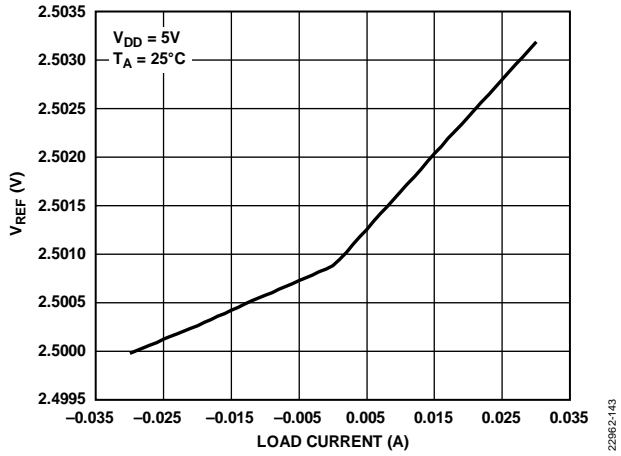

Figure 53.  $V_{REF}$  vs. Load Current

22982-143

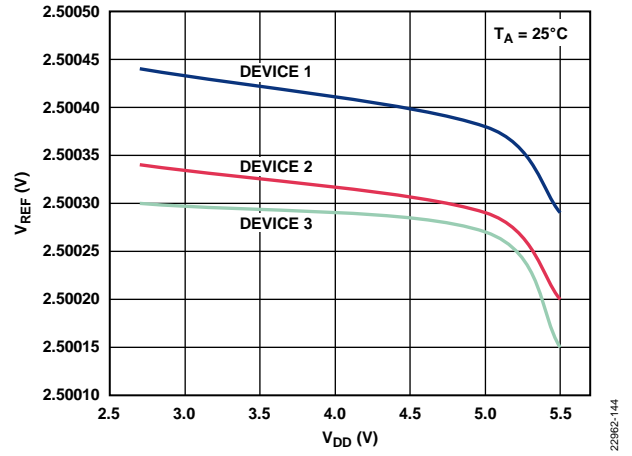

Figure 54.  $V_{REF}$  vs.  $V_{DD}$

22982-144

## TERMINOLOGY

### Relative Accuracy or Integral Nonlinearity (INL)

For the DAC, relative accuracy or integral nonlinearity is a measurement of the maximum deviation, in LSBs, from a straight line passing through the endpoints of the DAC transfer function.

### Differential Nonlinearity (DNL)

Differential nonlinearity is the difference between the measured change and the ideal 1 LSB change between any two adjacent codes. A specified differential nonlinearity of  $\pm 1$  LSB maximum ensures monotonicity. These DACs are guaranteed monotonic by design.

### Zero Code Error

Zero code error is a measurement of the output error when zero code (0x0000) is loaded to the DAC register. The ideal output is 0 V. The zero code error is always positive because the output of the DAC cannot go below 0 V due to a combination of the offset errors in the DAC and the output amplifier. Zero code error is expressed in mV.

### Full-Scale Error

Full-scale error is a measurement of the output error when full-scale code (0xFFFF) is loaded to the DAC register. The ideal output is  $V_{REF} - 1$  LSB (gain = 1) or  $2 \times V_{REF}$  (gain = 2). Full-scale error is expressed in percent of full-scale range (% of FSR).

### Gain Error

Gain error is a measure of the span error of the DAC. It is the deviation in slope of the DAC transfer characteristic from the ideal expressed as % of FSR.

### Offset Error Drift

Offset error drift is a measurement of the change in offset error with a change in temperature. It is expressed in  $\mu\text{V}/^\circ\text{C}$ .

### Offset Error

Offset error is a measure of the difference between  $V_{OUT}$  (actual) and  $V_{OUT}$  (ideal) expressed in mV in the linear region of the transfer function. Offset error is measured with Code 256 loaded in the DAC register. It can be negative or positive.

### DC Power Supply Rejection Ratio (PSRR)

The dc power supply rejection ratio indicates how the output of the DAC is affected by changes in the supply voltage. PSRR is the ratio of the change in  $V_{OUTX}$  to a change in  $V_{DD}$  for full-scale output of the DAC. It is measured in mV/V.  $V_{REF}$  is held at 2 V, and  $V_{DD}$  is varied by  $\pm 10\%$ .

### Output Voltage Settling Time

The output voltage settling time is the amount of time it takes for the output of a DAC to settle to a specified level for a  $\frac{1}{4}$  to  $\frac{3}{4}$  full-scale input change.

### Digital-to-Analog Glitch Impulse

Digital-to-analog glitch impulse is the impulse injected into the analog output when the input code in the DAC register changes state. It is normally specified as the area of the glitch in nV-sec, and is measured when the digital input code is changed by 1 LSB at the major carry transition (0x7FFF to 0x8000).

### Digital Feedthrough

Digital feedthrough is a measure of the impulse injected into the analog output of the DAC from the digital inputs of the DAC, but is measured when the DAC output is not updated. It is specified in nV-sec, and measured with a full-scale code change on the data bus, that is, from all 0s to all 1s and vice versa.

### Noise Spectral Density (NSD)

Noise spectral density is a measurement of the internally generated random noise. Random noise is characterized as a spectral density ( $\text{nV}/\sqrt{\text{Hz}}$ ). It is measured by loading the DAC to midscale and measuring noise at the output. It is measured in  $\text{nV}/\sqrt{\text{Hz}}$ .

### DC Crosstalk

DC crosstalk is the dc change in the output level of one DAC in response to a change in the output of another DAC. It is measured with a full-scale output change on one DAC (or soft power-down and power-up) while monitoring another DAC kept at midscale. It is expressed in  $\mu\text{V}$ .

DC crosstalk due to load current change is a measure of the impact that a change in load current on one DAC has on another DAC kept at midscale. It is expressed in  $\mu\text{V}/\text{mA}$ .

### Digital Crosstalk

Digital crosstalk is the glitch impulse transferred to the output of one DAC at midscale in response to a full-scale code change (all 0s to all 1s and vice versa) in the input register of another DAC. It is measured in standalone mode and is expressed in nV-sec.

### Analog Crosstalk

Analog crosstalk is the glitch impulse transferred to the output of one DAC due to a change in the output of another DAC. It is measured by first loading one of the input registers with a full-scale code change (all 0s to all 1s and vice versa). Then, execute a software LDAC and monitor the output of the DAC whose digital code was not changed. The area of the glitch is expressed in nV-sec.

### DAC to DAC Crosstalk

DAC to DAC crosstalk is the glitch impulse transferred to the output of one DAC due to a digital code change and subsequent analog output change of another DAC. DAC to DAC crosstalk is measured with a full-scale change on one DAC output (all 0s to all 1s and vice versa), using the write to and update commands, while monitoring the other DAC output kept at midscale. The energy of the glitch is expressed in nV-sec.

**Total Harmonic Distortion (THD)**

THD is the difference between an ideal sine wave and its attenuated version using the DAC. The sine wave is used as the reference for the DAC, and the THD is a measurement of the harmonics present on the DAC output. It is measured in dB.

**Voltage Reference Temperature Coefficient (TC)**

Voltage reference TC is a measure of the change in the reference output voltage with a change in temperature. The reference TC is calculated using the box method, which defines the TC as the maximum change in the reference output over a given temperature range expressed in ppm/°C, as follows:

$$TC = \left( \frac{V_{REF\_MAX} - V_{REF\_MIN}}{V_{REF\_NOM} \times TEMP\_RANGE} \right) \times 10^6$$

where:

$V_{REF\_MAX}$  is the maximum reference output measured over the total temperature range.

$V_{REF\_MIN}$  is the minimum reference output measured over the total temperature range.

$V_{REF\_NOM}$  is the nominal reference output voltage, 2.5 V.

$TEMP\_RANGE$  is the specified temperature range of -40°C to +125°C.

## THEORY OF OPERATION

### DIGITAL-TO-ANALOG CONVERTER (DAC)

The AD5673R/AD5677R are 16-channel, 12-/16-bit, serial input, voltage output DACs with an internal reference. The devices operate from supply voltages of 2.7 V to 5.5 V. Data is written to the AD5673R/AD5677R in a 24-bit word format via a 2-wire serial interface. The AD5673R/AD5677R incorporate a power-on reset circuit to ensure that the DAC output powers up to a known output state. The devices also have a software power-down mode that reduces the typical current consumption to 2  $\mu$ A.

### TRANSFER FUNCTION

The internal reference is on by default.

The gain of the output amplifier can be set to  $\times 1$  or  $\times 2$  using the span set pin (GAIN). When the GAIN pin is tied to GND, all 16 DAC outputs have a span from 0 V to  $V_{REF}$ . When the GAIN pin is tied to VLOGIC, all 16 DACs output a span of 0 V to  $2 \times V_{REF}$ .

### DAC ARCHITECTURE

The AD5673R/AD5677R implement a segmented string DAC architecture with an internal output buffer. Figure 55 shows the internal block diagram.

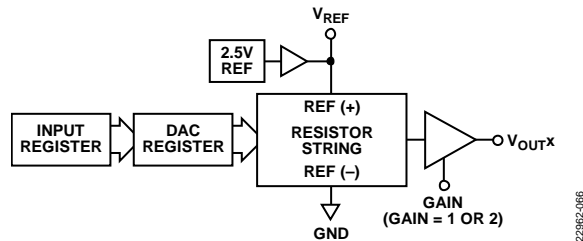

Figure 55. Single DAC Channel Architecture Block Diagram

The resistor string structure is shown in Figure 56.

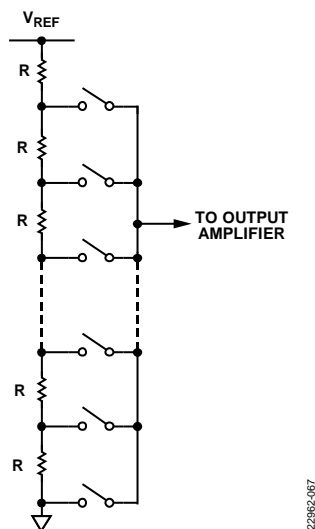

Figure 56. Resistor String Structure

The code loaded to the DAC register determines the node on the string where the voltage is tapped off and fed into the output amplifier. The voltage is tapped off by closing one of the switches and connecting the string to the amplifier. Because each resistance in the string has the same value,  $R$ , the string DAC is guaranteed monotonic.

### Internal Reference

The AD5673R/AD5677R on-chip reference is enabled at power-up, but the on-chip reference can be disabled via a write to the control register. See the Internal Reference Setup section for details.

The AD5673R/AD5677R have a 2.5 V, 2 ppm/ $^{\circ}$ C reference, giving a full-scale output of 2.5 V or 5 V, depending on the state of the GAIN pin. The internal reference associated with the device is available at the VREF pin. This buffered reference is capable of driving external loads of up to 15 mA.

### Output Amplifiers

The output buffer amplifier generates rail-to-rail voltages on its output, which gives an output range of 0 V to  $V_{DD}$ . The actual range depends on the value of the voltage reference level ( $V_{REF}$ ) the GAIN pin, the offset error, and the gain error.

The output amplifiers can drive a load of 1 k $\Omega$  in parallel with 10 nF to GND. The slew rate is 0.8 V/ $\mu$ s with a typical  $\frac{1}{4}$  to  $\frac{3}{4}$  scale settling time of 6  $\mu$ s.

### SERIAL INTERFACE

The AD5673R/AD5677R use a 2-wire, I<sup>2</sup>C-compatible serial interface. These devices can be connected to an I<sup>2</sup>C bus as a slave device under the control of the master devices. The AD5673R/AD5677R support standard (100 kHz) and fast (400 kHz) data transfer modes. Support is not provided for 10-bit addressing and general call addressing.

### Input Shift Register

The input shift register of the AD5673R/AD5677R is 24 bits wide. Data is loaded MSB first (DB23), and the first four bits are the command bits, C3 to C0 (see Table 9), followed by the 4-bit DAC address bits, A3 to A0 (see Table 10), and finally, the 16-bit data-word.

The data-word comprises a 16-bit input code for the AD5677R, and a 12-bit input code followed by four zeros, or don't care bits, for the AD5673R (see Figure 57 and Figure 58). These data bits are transferred to the input register on the 24 falling edges of SCL.

Commands execute on individual DAC channels, combined DAC channels, or on all DACs, depending on the address bits selected.

|              |      |      |      |                |      |      |      |          |      |      |      |               |      |     |     |          |     |     |     |     |     |     |     |
|--------------|------|------|------|----------------|------|------|------|----------|------|------|------|---------------|------|-----|-----|----------|-----|-----|-----|-----|-----|-----|-----|
| DB23         | DB22 | DB21 | DB20 | DB19           | DB18 | DB17 | DB16 | DB15     | DB14 | DB13 | DB12 | DB11          | DB10 | DB9 | DB8 | DB7      | DB6 | DB5 | DB4 | DB3 | DB2 | DB1 | DB0 |
| C3           | C2   | C1   | C0   | A3             | A2   | A1   | A0   | D15      | D14  | D13  | D12  | D11           | D10  | D9  | D8  | D7       | D6  | D5  | D4  | D3  | D2  | D1  | D0  |
| COMMAND      |      |      |      | DAC ADDRESS    |      |      |      | DAC DATA |      |      |      |               |      |     |     | DAC DATA |     |     |     |     |     |     |     |
| COMMAND BYTE |      |      |      | DATA HIGH BYTE |      |      |      |          |      |      |      | DATA LOW BYTE |      |     |     |          |     |     |     |     |     |     |     |

Figure 57. AD5677R Input Shift Register Content

|              |      |      |      |                |      |      |      |          |      |      |      |               |      |     |     |          |     |     |     |     |     |     |     |
|--------------|------|------|------|----------------|------|------|------|----------|------|------|------|---------------|------|-----|-----|----------|-----|-----|-----|-----|-----|-----|-----|
| DB23         | DB22 | DB21 | DB20 | DB19           | DB18 | DB17 | DB16 | DB15     | DB14 | DB13 | DB12 | DB11          | DB10 | DB9 | DB8 | DB7      | DB6 | DB5 | DB4 | DB3 | DB2 | DB1 | DB0 |
| C3           | C2   | C1   | C0   | A3             | A2   | A1   | A0   | D11      | D10  | D9   | D8   | D7            | D6   | D5  | D4  | D3       | D2  | D1  | D0  | X   | X   | X   | X   |
| COMMAND      |      |      |      | DAC ADDRESS    |      |      |      | DAC DATA |      |      |      |               |      |     |     | DAC DATA |     |     |     |     |     |     |     |
| COMMAND BYTE |      |      |      | DATA HIGH BYTE |      |      |      |          |      |      |      | DATA LOW BYTE |      |     |     |          |     |     |     |     |     |     |     |

Figure 58. AD5673R Input Shift Register Content

Table 9. Command Definitions

| Command |     |     |     | Description   |
|---------|-----|-----|-----|---|
| C3      | C2  | C1  | C0  |   |
| 0       | 0   | 0   | 0   | No operation  |
| 0       | 0   | 0   | 1   | Write to Input Register x (dependent on LDAC)   |
| 0       | 0   | 1   | 0   | Update DAC Register x with contents of Input Register x                                       |
| 0       | 0   | 1   | 1   | Write to and update DAC Channel x (Independent of LDAC)                                       |
| 0       | 1   | 0   | 0   | Power down/power up the DAC   |
| 0       | 1   | 0   | 1   | Hardware LDAC mask register   |
| 0       | 1   | 1   | 0   | Software reset (power-on reset)   |
| 0       | 1   | 1   | 1   | Internal reference setup register   |
| 1       | 0   | 0   | 0   | Reserved  |
| 1       | 0   | 0   | 1   | Set up the readback register (readback enable)  |
| 1       | 0   | 1   | 0   | Update all channels of the input register simultaneously with the input data                  |
| 1       | 0   | 1   | 1   | Update all channels of the DAC register and input register simultaneously with the input data |
| 1       | 1   | 0   | 0   | Reserved  |
| ...     | ... | ... | ... |   |
| 1       | 1   | 1   | 1   | Reserved  |

Table 10. Address Commands

| DAC Address, Bits[3:0] |    |    |    | Selected Channel |
|------------------------|----|----|----|------------------|
| A3                     | A2 | A1 | A0 |                  |
| 0                      | 0  | 0  | 0  | DAC 0            |
| 0                      | 0  | 0  | 1  | DAC 1            |
| 0                      | 0  | 1  | 0  | DAC 2            |
| 0                      | 0  | 1  | 1  | DAC 3            |
| 0                      | 1  | 0  | 0  | DAC 4            |
| 0                      | 1  | 0  | 1  | DAC 5            |
| 0                      | 1  | 1  | 0  | DAC 6            |
| 0                      | 1  | 1  | 1  | DAC 7            |
| 1                      | 0  | 0  | 0  | DAC 8            |
| 1                      | 0  | 0  | 1  | DAC 9            |
| 1                      | 0  | 1  | 0  | DAC 10           |
| 1                      | 0  | 1  | 1  | DAC 11           |
| 1                      | 1  | 0  | 0  | DAC 12           |
| 1                      | 1  | 0  | 1  | DAC 13           |
| 1                      | 1  | 1  | 0  | DAC 14           |
| 1                      | 1  | 1  | 1  | DAC 15           |



## WRITE AND UPDATE COMMANDS

### Write to Input Register $x$ (Dependent on $\overline{\text{LDAC}}$ )

Command 0001 allows the user to write the dedicated input register of each DAC individually. When  $\overline{\text{LDAC}}$  is low, the input register is transparent if the transparency is not controlled by the  $\overline{\text{LDAC}}$  mask register.

### Update DAC Register $x$ with Contents of Input Register $x$

Command 0010 loads the DAC registers with the contents of the input registers selected and updates the DAC outputs directly. Data Bit D15 to Bit D0 determine which DACs have data from the input register transferred to the DAC register. Setting a bit to 1 transfers data from the input register to the appropriate DAC register.

### Write to and Update DAC Channel $x$ (Independent of $\overline{\text{LDAC}}$ )

Command 0011 allows the user to write to the DAC registers and updates the DAC outputs directly. The DAC address bits select the DAC channel.

## I<sup>2</sup>C SLAVE ADDRESS

The AD5673R/AD5677R have a 7-bit I<sup>2</sup>C slave address. The five MSBs are 00011, and the two LSBs (A1 and A0) are set by the state of the A1 and A0 address pins. The ability to make hardwired changes to A1 and A0 allows the user to incorporate up to four AD5673R or AD5677R devices on one bus (see Table 11).

**Table 11. Device Address Selection**

| A1 Pin Connection | A0 Pin Connection | A1 | A0 |
|-------------------|-------------------|----|----|
| GND               | GND               | 0  | 0  |
| GND               | VLOGIC            | 0  | 1  |
| VLOGIC            | GND               | 1  | 0  |
| VLOGIC            | VLOGIC            | 1  | 1  |

## SERIAL OPERATION

The 2-wire I<sup>2</sup>C serial bus protocol operates as follows:

1. The master initiates a data transfer by establishing a start condition when a high to low transition on the SDA line occurs while SCL is high. The following byte is the address byte, which consists of the 7-bit slave address.
2. The slave device with the transmitted address responds by pulling SDA low during the ninth clock pulse (this is called the acknowledge bit, or ACK). At this stage, all other devices on the bus remain idle while the selected device waits for data to be written to or read from its input shift register.
4. Data is transmitted over the serial bus in sequences of nine clock pulses (eight data bits followed by an acknowledge bit). Transitions on the SDA line must occur during the low period of SCL. SDA must remain stable during the high period of SCL.
5. After all data bits are read or written, a stop condition is established. In write mode, the master pulls the SDA line high during the 10<sup>th</sup> clock pulse to establish a stop condition. In read mode, the master issues a no acknowledge (NACK)

for the ninth clock pulse (that is, the SDA line remains high). The master then brings the SDA line low before the 10<sup>th</sup> clock pulse, and then high again during the 10<sup>th</sup> clock pulse to establish a stop condition.

## WRITE OPERATION

When writing to the AD5673R/AD5677R, begin with a start command followed by an address byte ( $\text{R}/\overline{\text{W}} = 0$ ), after which the DAC acknowledges that it is prepared to receive data by pulling SDA low. The AD5673R/AD5677R require two bytes of data for the DAC and a command byte to control various DAC functions. Three bytes of data must therefore be written to the DAC with the command byte followed by the most significant data byte and the least significant data byte, as shown in Figure 59. All these data bytes are acknowledged by the AD5673R/AD5677R. A stop condition follows.

## READ OPERATION

When reading data back from the AD5673R/AD5677R, begin with a start command followed by an address byte ( $\text{R}/\overline{\text{W}} = 0$ ), after which the DAC acknowledges that it is prepared to receive data by pulling SDA low. The address byte must be followed by the command byte, which determines both the read command (0x9) that is to follow and the pointer address to read from. The command byte is also acknowledged by the DAC. The user configures the channel to read back the contents of one or more DAC input registers and, using the command byte, sets the readback command to active. The command byte must be followed by two dummy bytes of data.

Then, the master establishes a repeated start condition, and the address is resent with  $\text{R}/\overline{\text{W}} = 1$ . This byte is acknowledged by the DAC, indicating that it is prepared to transmit data. Two bytes of data are then read from the DAC, as shown in Figure 60. A no acknowledge condition from the master, followed by a stop condition, completes the read sequence. If more than one DAC is selected, DAC 0 is read back by default.

## MULTIPLE DAC READBACK SEQUENCE

When reading data back from multiple AD5673R/AD5677R DACs, the user begins with an address byte ( $\text{R}/\overline{\text{W}} = 0$ ), after which the DAC acknowledges that it is prepared to receive data by pulling SDA low. The address byte must be followed by the command byte. The command byte, which determines both the read command (0x9) that is to follow and the pointer address to read from, is also acknowledged by the DAC. The user selects the first channel to read back using the command byte. The command byte must be followed by two dummy bytes of data.

Following this sequence, the master establishes a repeated start condition, and the address is resent with  $\text{R}/\overline{\text{W}} = 1$ . This byte is acknowledged by the DAC, indicating that it is prepared to transmit data. The first two bytes of data are then read from DAC Input Register  $x$  (selected using the command byte), MSB first, as shown in Figure 60.

The next two bytes read back are the contents of DAC Input Register  $x + 1$ , and the next bytes read back are the contents of DAC Input Register  $x + 2$ . Data is read from the DAC input registers in this auto-incremented fashion until a no

acknowledge followed by a stop condition follows. If the contents of DAC Input Register 15 are read out, the next two bytes of data read are the contents of DAC Input Register 0.

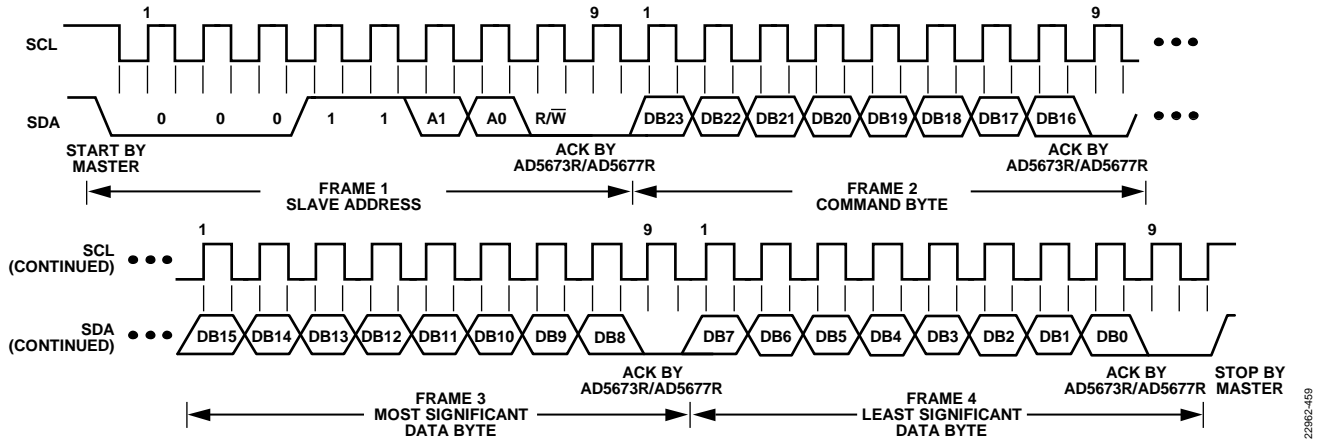

Figure 59. I<sup>2</sup>C Write Operation

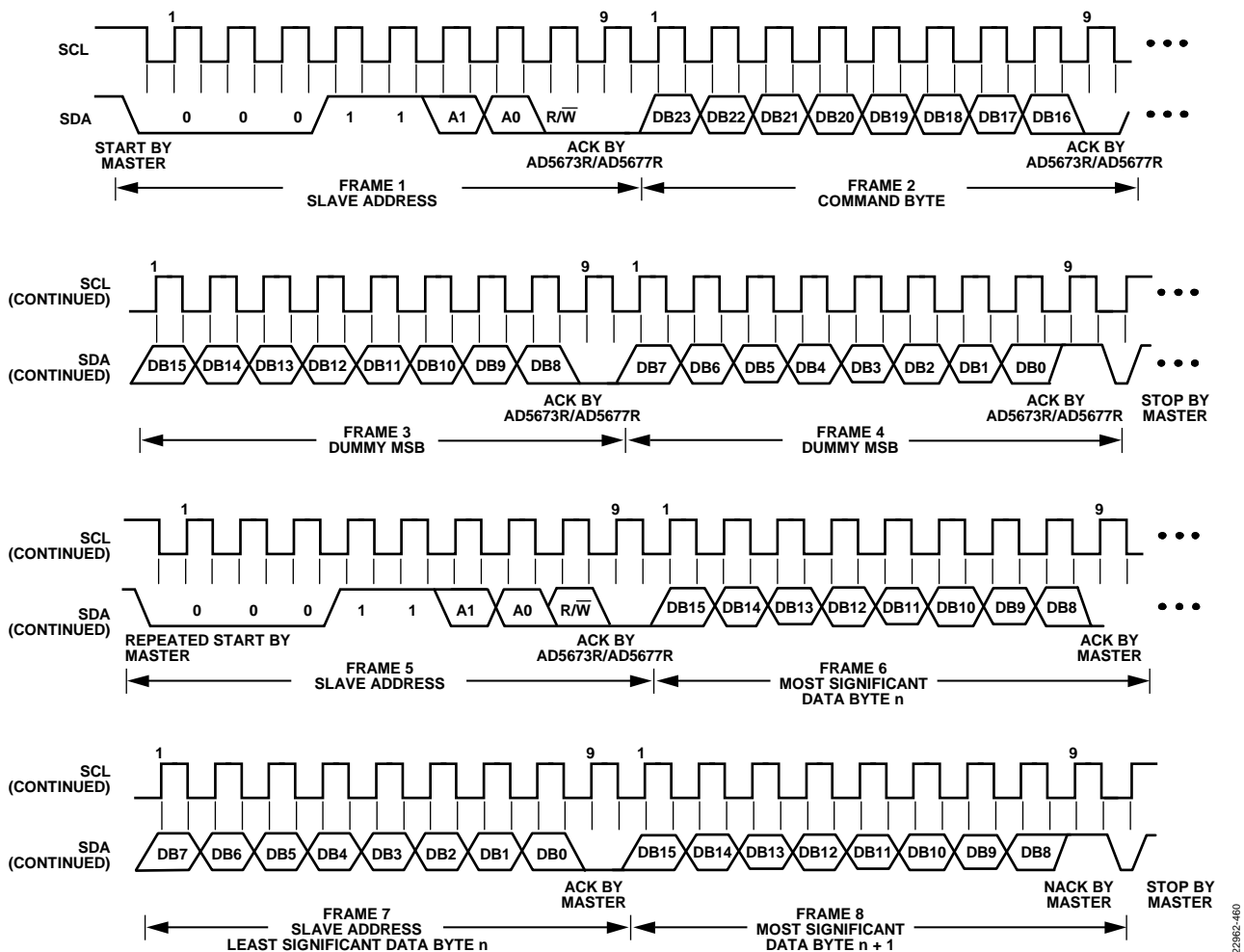

Figure 60. I<sup>2</sup>C Read Operation

**POWER-DOWN OPERATION**

Command 0100 is designated for the power-down function (see Table 9). These power-down modes are software programmable by setting 16 bits, Bit DB15 to Bit DB0, in the input shift register. Two bits are associated with each DAC channel (PD0 and PD1). Table 12 shows how the state of the two bits corresponds to the mode of operation of the device.

Any or all DACs (DAC 0 to DAC 15) power down to the selected mode by setting the corresponding bits. See Table 13 and Table 14 for the contents of the input shift register during the power-down/power-up operation.

**Table 12. Modes of Operation**

| PD1 | PD0 | Operating Mode               |
|-----|-----|------------------------------|
| 0   | 0   | Normal operation             |
| 0   | 1   | Power-down mode: 1 kΩ to GND |

When both Bit PD1 and Bit PD0 in the input shift register are set to 0, the device works normally with its normal power consumption of typically 2.3 mA at 5 V. However, for the 1 kΩ to GND power-down mode, the supply current decreases to typically 2 μA. In addition to this decrease, the output stage switches internally from the amplifier output to a resistor network of known value. Therefore, the DAC channel output impedance is defined when the channel is powered down by internally connecting the output to GND through a 1 kΩ resistor. The output stage is shown in Figure 61.

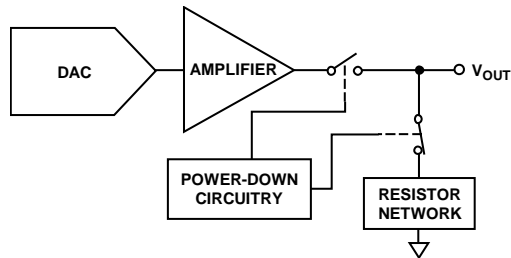

Figure 61. Output Stage During Power-Down

The bias generator, output amplifier, resistor string, and other associated linear circuitry are shut down when power-down mode is activated. However, the contents of the DAC registers are unaffected in power-down mode, and the DAC registers can be updated while the device is in power-down mode. The time required to exit power-down is typically 3 μs for V<sub>DD</sub> = 5 V.

To reduce the current consumption further, power off the on-chip reference. See the Internal Reference Setup section.

**LOAD DAC (HARDWARE LDAC PIN)**

The AD5673R/AD5677R DACs have double buffered interfaces consisting of two banks of registers: input registers and DAC registers. The user can write to any combination of the input registers. Updates to the DAC registers are controlled by the LDAC pin.

**Instantaneous DAC Updating (LDAC Held Low)**

For instantaneous updating of the DACs, LDAC is held low while data is clocked into the input register using Command 0001. Both the addressed input register and the DAC register are updated on the 24<sup>th</sup> clock, and the output changes immediately.

**Deferred DAC Updating (LDAC is Pulsed Low)**

For deferred updating of the DACs, LDAC is held high while data is clocked into the input register using Command 0001. All DAC outputs are asynchronously updated by pulling LDAC low after the 24<sup>th</sup> clock. The update occurs on the falling edge of LDAC.

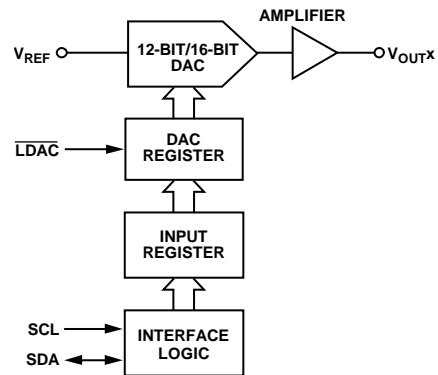

Figure 62. Simplified Diagram of Input Loading Circuitry for a Single DAC

**Table 13. 24-Bit Input Shift Register Contents of Power-Down/Power-Up Operation for DAC 7 to DAC 0 Output Channels**

| [DB23:DB20] | DB19        | [DB18:DB16]      | DAC 7     | DAC 6     | DAC 5     | DAC 4     | DAC 3     | DAC 2     | DAC 1     | DAC 0     |
|-------------|-------------|------------------|-----------|-----------|-----------|-----------|-----------|-----------|-----------|-----------|
| [DB15: B14] | [DB13: B12] | [DB11: B10]      | [DB9:DB8] | [DB7:DB6] | [DB5:DB4] | [DB3:DB2] | [DB1:DB0] |           |           |           |
| 0100        | 0           | XXX <sup>1</sup> | [PD1:PD0] | [PD1:PD0] | [PD1:PD0] | [PD1:PD0] | [PD1:PD0] | [PD1:PD0] | [PD1:PD0] | [PD1:PD0] |

<sup>1</sup> X means don't care.

**Table 14. 24-Bit Input Shift Register Contents of Power-Down/Power-Up Operation for DAC 15 to DAC 8 Output Channels**

| [DB23:DB20] | DB19        | [DB18:DB16]      | DAC 15    | DAC 14    | DAC 13    | DAC 12    | DAC 11    | DAC 10    | DAC 9     | DAC 8     |
|-------------|-------------|------------------|-----------|-----------|-----------|-----------|-----------|-----------|-----------|-----------|
| [DB15: B14] | [DB13: B12] | [DB11: B10]      | [DB9:DB8] | [DB7:DB6] | [DB5:DB4] | [DB3:DB2] | [DB1:DB0] |           |           |           |
| 0100        | 1           | XXX <sup>1</sup> | [PD1:PD0] | [PD1:PD0] | [PD1:PD0] | [PD1:PD0] | [PD1:PD0] | [PD1:PD0] | [PD1:PD0] | [PD1:PD0] |

<sup>1</sup> X means don't care.

## LDAC MASK REGISTER

Command 0101 is reserved for the hardware  $\overline{\text{LDAC}}$  function. The address bits are ignored. Writing to the DAC using Command 0101 loads the 16-bit  $\overline{\text{LDAC}}$  register (DB15 to DB0). The default for each channel is 0, that is, the  $\overline{\text{LDAC}}$  pin works normally. Setting DB15 to DB0 to 1 forces this DAC channel to ignore transitions on the  $\overline{\text{LDAC}}$  pin, regardless of the state of the hardware  $\overline{\text{LDAC}}$  pin. This flexibility is useful in applications where the user wants to select which channels respond to the  $\overline{\text{LDAC}}$  pin.

The  $\overline{\text{LDAC}}$  register gives the user extra flexibility and control over the hardware  $\overline{\text{LDAC}}$  pin (see Table 17). Setting the  $\overline{\text{LDAC}}$  bits (DB0 to DB15) to 0 for a DAC channel means that this channel update is controlled by the hardware  $\overline{\text{LDAC}}$  pin.

## HARDWARE RESET ( $\overline{\text{RESET}}$ )

The  $\overline{\text{RESET}}$  pin is an active low reset that allows the outputs to be cleared to either zero scale or midscale. The clear code value depends on the model in use and refers to the power-up voltage. It is necessary to keep the  $\overline{\text{RESET}}$  pin low for a minimum time (see Table 5) to complete the operation. When the  $\overline{\text{RESET}}$  signal is returned high, the output remains at the cleared value until a new value is programmed. While the  $\overline{\text{RESET}}$  pin is low, the outputs cannot be updated with a new value. Any events on  $\overline{\text{LDAC}}$  or  $\overline{\text{RESET}}$  during power-on reset are ignored. If the  $\overline{\text{RESET}}$  pin is pulled low at power-up, the device does not initialize correctly until the pin is released.

Table 16.  $\overline{\text{LDAC}}$  Overwrite Definition

| Load $\overline{\text{LDAC}}$ Register      |                              | $\overline{\text{LDAC}}$ Operation   |
|---|------------------------------|--|
| $\overline{\text{LDAC}}$ Bits (DB15 to DB0) | $\overline{\text{LDAC}}$ Pin |  |
| 0000000000000000                            | 1 or 0                       | Determined by the $\overline{\text{LDAC}}$ pin.  |
| 1111111111111111                            | X (don't care)               | DAC channels update and override the $\overline{\text{LDAC}}$ pin. DAC channels see $\overline{\text{LDAC}}$ as 1. |

Table 17. Write Commands and  $\overline{\text{LDAC}}$  Pin Truth Table<sup>1</sup>

| Command | Description  | Hardware $\overline{\text{LDAC}}$ Pin State | Input Register Contents    | DAC Register Contents  |
|---------|--|---|----------------------------|--|
| 0001    | Write to Input Register x (dependent on $\overline{\text{LDAC}}$ ) | VLOGIC<br>GND <sup>2</sup>                  | Data update<br>Data update | No change (no update)<br>Data update   |
| 0010    | Update DAC Register x with contents of Input Register x            | VLOGIC<br>GND                               | No change<br>No change     | Updated with input register contents<br>Updated with input register contents |
| 0011    | Write to and update DAC Channel x                                  | VLOGIC<br>GND                               | Data update<br>Data update | Data update<br>Data update   |

<sup>1</sup> A high to low hardware  $\overline{\text{LDAC}}$  pin transition always updates the contents of the contents of the DAC register with the contents of the input register on channels that are not masked (blocked) by the  $\overline{\text{LDAC}}$  mask register.

<sup>2</sup> When  $\overline{\text{LDAC}}$  is permanently tied low, the  $\overline{\text{LDAC}}$  mask bits are ignored.

Table 18. 24-Bit Input Shift Register Contents for Internal Reference Setup Command<sup>1</sup>

| DB23 (MSB)              | DB22 | DB21 | DB20 | DB19                    | DB18 | DB17 | DB16 | DB1 to DB3 | DB2      | DB1      | DB0 (LSB)                |
|-------------------------|------|------|------|-------------------------|------|------|------|------------|----------|----------|--------------------------|
| 0                       | 1    | 1    | 1    | X                       | X    | X    | X    | X          | 0        | 0        | 1/0                      |
| Command bits (C3 to C0) |      |      |      | Address bits (A3 to A0) |      |      |      | Don't care | Reserved | Reserved | Reference setup register |

<sup>1</sup> X means don't care.

## POWER-ON RESET INTERNAL CIRCUIT

The AD5673R/AD5677R contain a power-on reset circuit that controls the output voltage during power-up. Depending on the model selected, the output powers up to zero scale (AD5673R-1, AD5677R-1) or the output powers up to midscale (AD5673R-2, AD5677R-2). The output remains powered up at this level until a valid write sequence is made to the DAC.

## SOFTWARE RESET

A software executable reset function is also available, which resets the DAC to the power-on reset code. Command 0110 is designated for this software reset function. The DAC address bits must be set to 0x0 and the data bits set to 0x1234 for the software reset command to execute.

## INTERNAL REFERENCE SETUP

The on-chip reference is on at power-up by default. To reduce the supply current, turn off this reference by setting the software programmable bit, DB0, in the internal reference setup register.

Table 15 shows how the state of the bit corresponds to the mode of operation. Command 0111 is reserved for setting up the internal reference (see Table 9 and Table 18).

Table 15. Internal Reference Setup Register

| Bit | Description   |
|-----|---|
| DB2 | Reserved  |
| DB1 | Reserved; set to 0  |
| DB0 | Reference enable<br>DB0 = 0; internal reference enabled (default)<br>DB0 = 1; internal reference disabled |

### SOLDER HEAT REFLOW

As with all IC reference voltage circuits, the reference value experiences a shift induced by the soldering process. Analog Devices, Inc., performs a reliability test called precondition to mimic the effect of soldering a device to a board. The output voltage specification in Table 2 and Table 3 includes the effect of this reliability test.

Figure 63 shows the effect of solder heat reflow as measured through the reliability test (precondition).

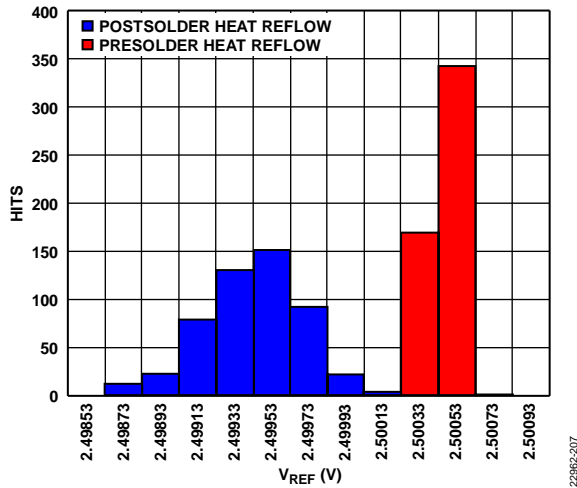

Figure 63. Solder Heat Reflow Reference Voltage Shift

### LONG-TERM TEMPERATURE DRIFT

Figure 64 shows the change in V<sub>REF</sub> value after 1000 hours in the life test at 150°C.

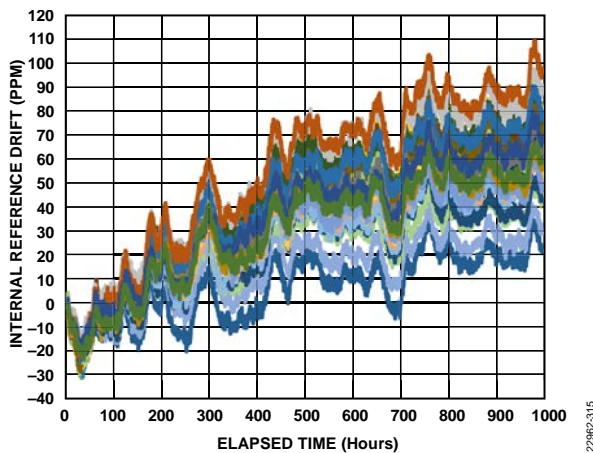

Figure 64. Reference Drift Through to 1000 Hours

### THERMAL HYSTERESIS

Thermal hysteresis is the voltage difference induced on the reference voltage by sweeping the temperature from ambient to cold, to hot, and then back to ambient.

Thermal hysteresis data is shown in Figure 65. Thermal hysteresis is measured by sweeping the temperature from ambient to -40°C, then to +125°C, and returning to ambient. ΔV<sub>REF</sub> is then measured between the two ambient measurements, as shown in Figure 65 (first temperature sweep).

The same temperature sweep and measurements were immediately repeated, and the results are shown in Figure 65 (subsequent temperature sweeps).

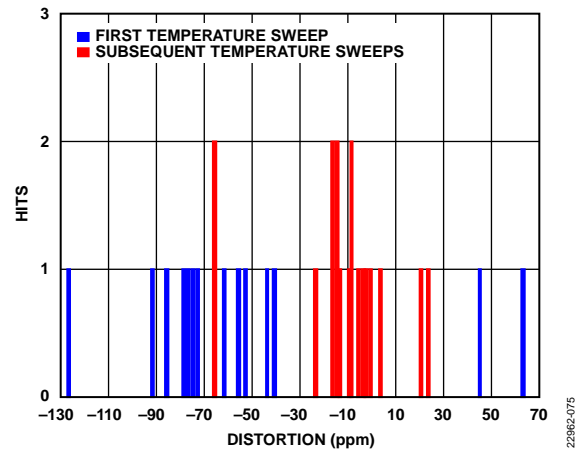

Figure 65. Thermal Hysteresis

## APPLICATIONS INFORMATION

### POWER SUPPLY RECOMMENDATIONS

The AD5673R/AD5677R are typically powered by the following supplies:  $V_{DD} = 3.3\text{ V}$  and  $V_{LOGIC} = 1.8\text{ V}$ .

The ADP7118 can be used to power the VDD pin. The ADP160 can be used to power the VLOGIC pin. Figure 66 shows this setup. The ADP7118 can operate from input voltages up to 20 V. The ADP160 can operate from input voltages up to 5.5 V.

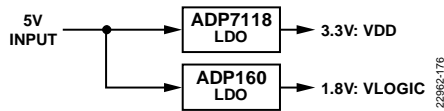

Figure 66. Low Noise Power Solution for the AD5673R/AD5677R

### MICROPROCESSOR INTERFACING

Microprocessor interfacing to the AD5673R/AD5677R uses a serial bus with a standard protocol that is compatible with DSP processors and microcontrollers. The communications channel requires a 2-wire interface consisting of a clock signal and a data signal.

### AD5673R/AD5677R TO ADSP-BF531 INTERFACE

The I<sup>2</sup>C interface of the AD5673R/AD5677R is designed for easy connection to industry-standard DSPs and microcontrollers. Figure 67 shows the AD5673R/AD5677R connected to the Analog Devices, Inc., ADSP-BF531 Blackfin® processor. The Blackfin processor has an integrated I<sup>2</sup>C port that can be connected directly to the I<sup>2</sup>C pins of the AD5673R/AD5677R.

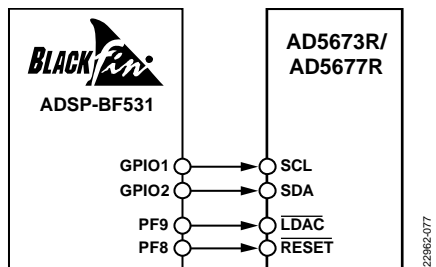

Figure 67. AD5673R/AD5677R to ADSP-BF531 Interface

### LAYOUT GUIDELINES

In any circuit where accuracy is important, careful consideration of the power supply and ground return layout helps to ensure the rated performance. Design the PCB on which the AD5673R or AD5677R is mounted so that the device lies on the analog plane.

The AD5673R/AD5677R must have ample supply bypassing of 10  $\mu\text{F}$  in parallel with 0.1  $\mu\text{F}$  on each supply, located as close to the package as possible, ideally right up against the device. The 10  $\mu\text{F}$  capacitors are tantalum bead type. The 0.1  $\mu\text{F}$  capacitor

must have low effective series resistance (ESR) and low effective series inductance (ESI), such as the common ceramic types, which provide a low impedance path to ground at high frequencies to handle transient currents due to internal logic switching.

In systems where there are many devices on one board, it is often useful to provide some heat sinking capability to allow the power to dissipate easily.

The GND plane on the device can be increased (as shown in Figure 68) to provide a natural heat sinking effect.

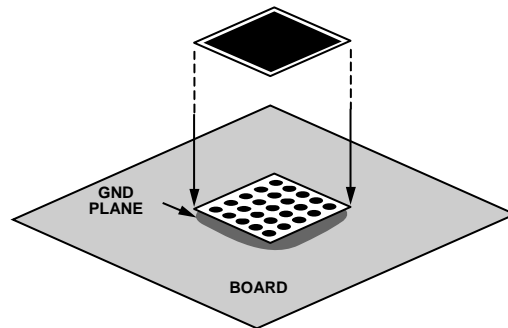
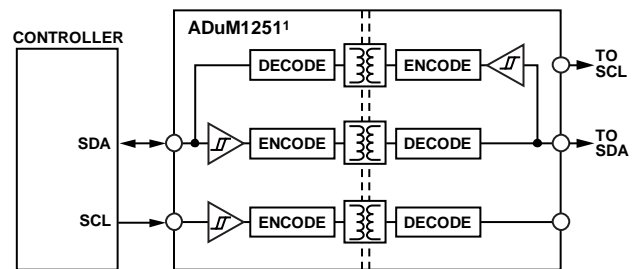

Figure 68. Pad Connection to Board

### GALVANICALLY ISOLATED INTERFACE

In many process control applications, it is necessary to provide an isolation barrier between the controller and the unit being controlled to protect and isolate the controlling circuitry from any hazardous common-mode voltages that may occur. iCoupler® products from Analog Devices provide voltage isolation in excess of 2.5 kV. The serial loading structure of the AD5673R/AD5677R makes the devices ideal for isolated interfaces because the number of interface lines is kept to a minimum. Figure 69 shows a 2-channel isolated interface to the AD5673R/AD5677R using an ADuM1251. For further information, visit [www.analog.com/icoupler](http://www.analog.com/icoupler).



<sup>1</sup>ADDITIONAL PINS OMITTED FOR CLARITY.

Figure 69. Isolated Interface



# OUTLINE DIMENSIONS

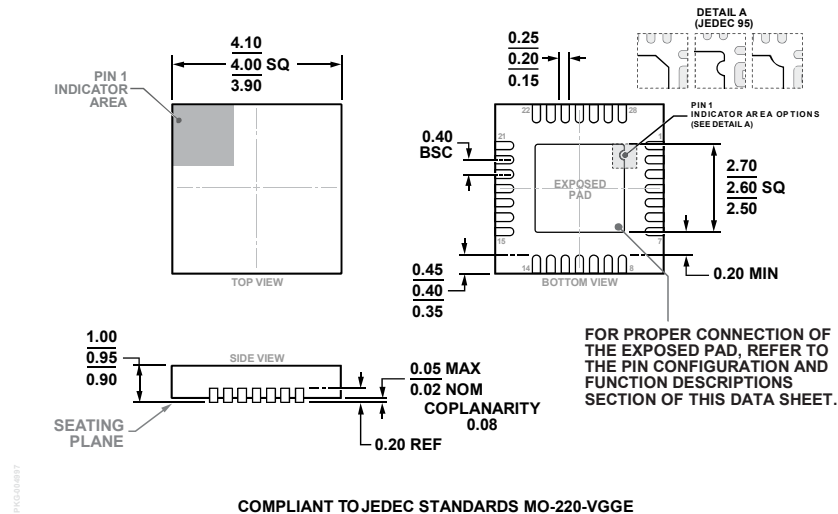

COMPLIANT TO JEDEC STANDARDS MO-220-VGGE  
 Figure 70. 28-Lead Lead Frame Chip Scale Package [LFCSP]  
 4 mm × 4 mm Body and 0.95 mm Package Height  
 (CP-28-9)  
 Dimensions shown in millimeters

## ORDERING GUIDE

| Model <sup>1,2</sup> | Resolution | Temperature Range | Reset Value | Package Description      | Package Option |
|----------------------|------------|-------------------|-------------|--------------------------|----------------|
| AD5673RBCPZ-1        | 12 Bits    | -40°C to +125°C   | Zero scale  | 28-Lead LFCSP            | CP-28-9        |
| AD5673RBCPZ-1-RL7    | 12 Bits    | -40°C to +125°C   | Zero scale  | 28-Lead LFCSP            | CP-28-9        |
| AD5673RBCPZ-2        | 12 Bits    | -40°C to +125°C   | Midscale    | 28-Lead LFCSP            | CP-28-9        |
| AD5673RBCPZ-2-RL7    | 12 Bits    | -40°C to +125°C   | Midscale    | 28-Lead LFCSP            | CP-28-9        |
| AD5677RBCPZ-1        | 16 Bits    | -40°C to +125°C   | Zero scale  | 28-Lead LFCSP            | CP-28-9        |
| AD5677RBCPZ-1-RL7    | 16 Bits    | -40°C to +125°C   | Zero scale  | 28-Lead LFCSP            | CP-28-9        |
| AD5677RBCPZ-2        | 16 Bits    | -40°C to +125°C   | Midscale    | 28-Lead LFCSP            | CP-28-9        |
| AD5677RBCPZ-2-RL7    | 16 Bits    | -40°C to +125°C   | Midscale    | 28-Lead LFCSP            | CP-28-9        |
| EVAL-AD5677RSDZ      |            |                   |             | AD5677R Evaluation Board |                |

<sup>1</sup> Z = RoHS Compliant Part.

<sup>2</sup> Use the EVAL-AD5677RSDZ to evaluate the AD5673R models.

I<sup>2</sup>C refers to a communications protocol originally developed by Philips Semiconductors (now NXP Semiconductors).