

ISL22511

Single Push Button Controlled Potentiometer (XDCP™) Low Noise, Low Power, 32 Taps, Push Button Controlled Potentiometer

The [ISL22511](#) is a three-terminal digitally-controlled potentiometer (XDCP) implemented by a resistor array composed of 31 resistive elements and a wiper switching network. The ISL22511 features a push button control, a Shutdown mode, and an industry-leading UTQFN package.

The push button control has individual \overline{PU} and \overline{PD} inputs for adjusting the wiper. To eliminate redundancy, the wiper position automatically increments or decrements if one of these inputs is held longer than one second.

Forcing both \overline{PU} and \overline{PD} low for more than two seconds activates shutdown mode. Shutdown mode disconnects the top of the resistor chain and moves the wiper to the lowest position to minimize power consumption.

The three terminals accessing the resistor chain naturally configure the ISL22511 as a voltage divider. A rheostat is easily formed by floating an end terminal or connecting it to the wiper.

Related Literature

For a full list of related documents, visit our website:

- [ISL22511](#) device page

Applications

- Volume control
- LED/LCD brightness control
- Contrast control
- Programming bias voltages
- Ladder networks

Features

- Solid-state non-volatile potentiometer
- Push button controlled
- Single or auto increment/decrement
 - Fast mode after 1s button press
- AUTOSTORE of last wiper position or manual store of wiper position
- Shutdown mode
- 32 wiper tap points
 - Max scale wiper position on power-up
- Low power CMOS
 - $V_{CC} = 2.7V$ to $5.5V$
 - Terminal voltage, $0V$ to V_{CC}
 - Standby current, $3\mu A$ max
- R_{TOTAL} value = $10k\Omega$
- High reliability
 - Endurance: 1000000 data changes per bit per register
 - Register data retention: 50 years at $T \leq +55^\circ C$
- Packages
 - 8 Ld SOIC
 - 10 Ld UTQFN (2.1mmx1.6mm)
- Pb-free (RoHS compliant)

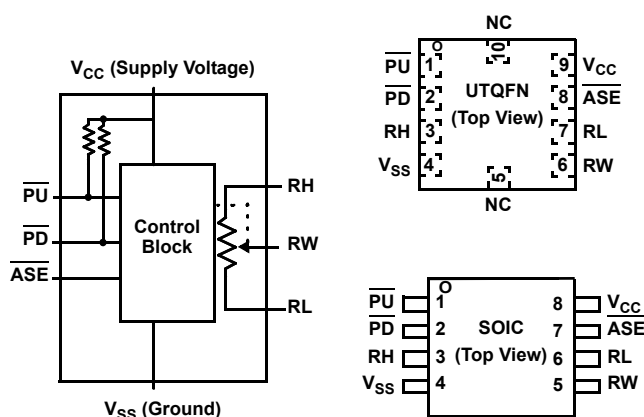

1. Overview

1.1 Block Diagrams

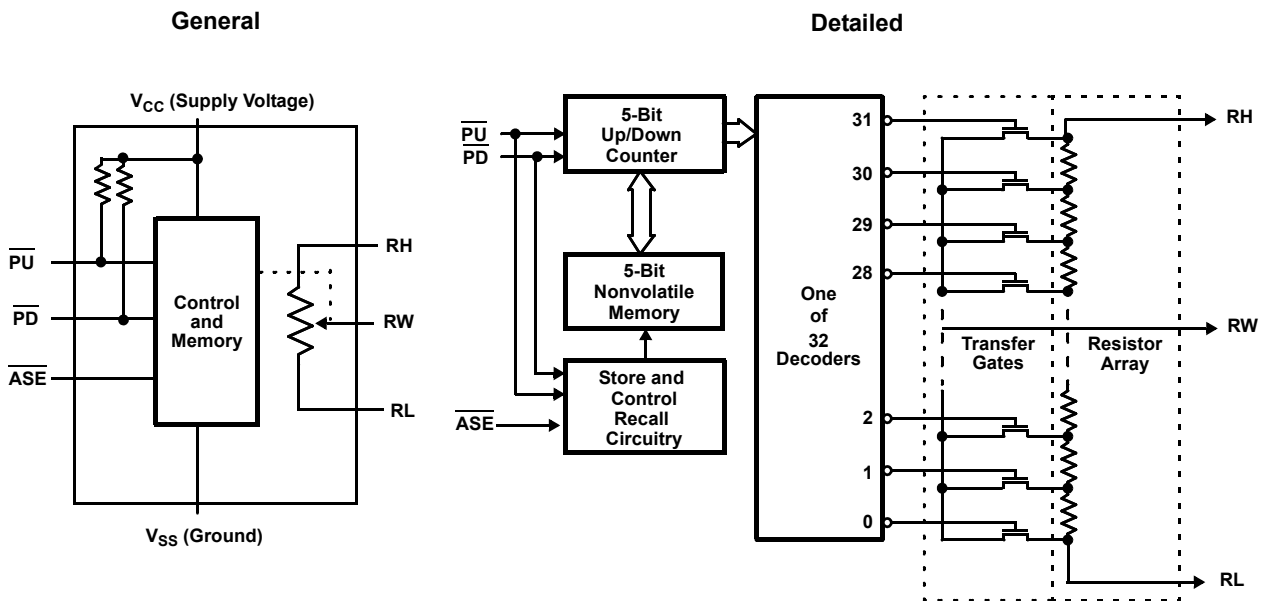

Figure 1. Block Diagrams

1.2 Ordering Information

Part Number (Note 4)	Part Marking	R _{TOTAL} (kΩ)	Temp. Range (°C)	Tape and Reel (Units) (Note 1)	Package (RoHS Compliant)	Pkg. Dwg. #
ISL22511WFRU10Z-TK (Note 3)	GD	10	-40 to +125	1k	10 Ld UTQFN	L10.2.1x1.6A
ISL22511WFB8Z (No longer available or supported) (Note 2)	22511 WFBZ	10	-40 to +125	-	8 Ld SOIC	M8.15

Notes:

- See [TB347](#) for details about reel specifications.
- These Pb-free plastic packaged products employ special Pb-free material sets, molding compounds/die attach materials, and 100% matte tin plate plus anneal (e3 termination finish, which is RoHS compliant and compatible with both SnPb and Pb-free soldering operations). Pb-free products are MSL classified at Pb-free peak reflow temperatures that meet or exceed the Pb-free requirements of IPC/JEDEC J-STD-020.
- These Pb-free plastic packaged products employ special Pb-free material sets; molding compounds/die attach materials and NiPdAu-Ag plate - e4 termination finish, which is RoHS compliant and compatible with both SnPb and Pb-free soldering operations. Pb-free products are MSL classified at Pb-free peak reflow temperatures that meet or exceed the Pb-free requirements of IPC/JEDEC J-STD-020.
- For Moisture Sensitivity Level (MSL), see the [ISL22511](#) device page. For more information about MSL, see [TB363](#).

1.3 Pin Configurations

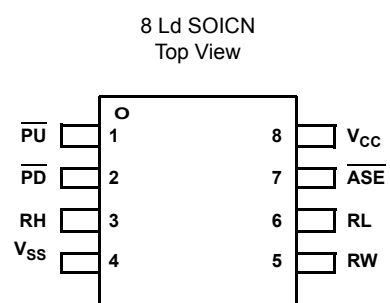
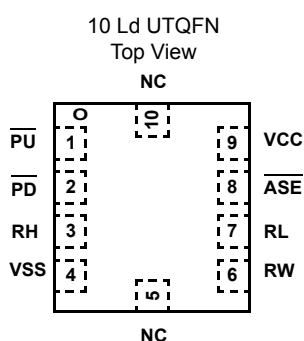

1.4 Pin Descriptions

UTQFN Pin	SOIC Pin	Symbol	Description
1	1	$\overline{\text{PU}}$	Falling-edge triggered input with internal pull-up. Toggle $\overline{\text{PU}}$ to move the wiper close to the RH terminal. The debounced $\overline{\text{PU}}$ input increments the wiper position. An on-chip pull-up holds the $\overline{\text{PU}}$ input HIGH. A switch closure to ground or a LOW logic level moves the wiper to the next adjacent higher tap position after a debounce time.
2	2	$\overline{\text{PD}}$	Falling-edge triggered input with internal pull-up. Toggle $\overline{\text{PD}}$ to move the wiper close to the RL terminal. The debounced $\overline{\text{PD}}$ input decrements the wiper position. An on-chip pull-up holds the $\overline{\text{PD}}$ input HIGH. A switch closure to ground or a LOW logic level moves the wiper to the next adjacent lower tap position after a debounce time.
3	3	RH	The RH and RL pins are equivalent to the fixed terminals of a mechanical potentiometer. The minimum voltage is V_{SS} and the maximum voltage is V_{CC} . The terms RH and $\overline{\text{RL}}$ refer to the relative position of the terminal in relation to the wiper movement direction selected by the $\overline{\text{PU}}/\overline{\text{PD}}$ input.
4	4	VSS	Ground
5, 10	-	NC	No connection
6	5	RW	Wiper terminal of the potentiometer, which is equivalent to the movable terminal of a mechanical potentiometer.
7	6	RL	The RH and RL pins are equivalent to the fixed terminals of a mechanical potentiometer. The minimum voltage is V_{SS} and the maximum voltage is V_{CC} . The terms RH and $\overline{\text{RL}}$ refer to the relative position of the terminal in relation to the wiper movement direction selected by the $\overline{\text{PU}}/\overline{\text{PD}}$ input.
8	7	$\overline{\text{ASE}}$	Active low AUTOSTORE enable input or Manual Store active low input. The debounced $\overline{\text{ASE}}$ pin can be in one of two states: <ul style="list-style-type: none"> AUTOSTORE is enabled if $\overline{\text{ASE}}$ is held LOW during power up. AUTOSTORE is disabled if $\overline{\text{ASE}}$ is held HIGH during power-up. A LOW to HIGH transition initiates a manual store operation to enable connection of a push button switch to this pin. For every valid push, the ISL22511 stores the current wiper position to the EEPROM.
9	8	VCC	Supply voltage

2. Specifications

2.1 Absolute Maximum Ratings

Parameter	Minimum	Maximum	Unit
Storage Temperature	-65	+150	°C
Voltage at $\overline{\text{PU}}$ and $\overline{\text{PD}}$ pin with respect to GND	-0.3	$V_{\text{CC}} + 0.3$	V
V_{CC}	-0.3	+6	V
Voltage at any DCP pin with respect to GND	-0.3	V_{CC}	V
I_{W} (10s)		±6	mA
ESD Rating	Value		Unit
Human Body Model (Tested per JS-001-2017)	4		kV
Machine Model	300		V
Latch-Up (Tested per JESD78E; Class 2, Level A)	100		mA

CAUTION: Do not operate at or near the maximum ratings listed for extended periods of time. Exposure to such conditions can adversely impact product reliability and result in failures not covered by warranty.

2.2 Thermal Information

Thermal Resistance (Typical)	θ_{JA} (°C/W)	θ_{JC} (°C/W)
10 Lead UTQFN Package (Notes 5, 6)	150	48.3
8 Lead SOIC Package (Note 5)	125	N/A

Notes:

- θ_{JA} is measured in free air with the component mounted on a high-effective thermal conductivity test board with “direct attach” features. See [TB379](#).
- θ_{JC} is for the location in the center of the exposed metal pad on the package underside.

Parameter	Minimum	Maximum	Unit
Maximum Junction Temperature (Plastic Package)		+150	°C
Pb-Free Reflow Profile	see TB493		

2.3 Recommended Operation Conditions

Parameter	Minimum	Maximum	Unit
Temperature Range (Extended Industrial)	-40	+125	°C
V_{CC}	2.7	5.5	V
Power Rating		15	mW
Wiper Current		±3.0	mA

2.4 Electrical Specifications

2.4.1 Potentiometer Specifications

Over recommended operating conditions, unless otherwise specified.

Parameter	Symbol	Test Conditions	Min (Note 20)	Typ (Note 7)	Max (Note 20)	Unit
RH to RL Resistance	R_{TOTAL}			10		k Ω
RH to RL Resistance Tolerance			-20		+20	%
End-to-End Temperature Coefficient				±80		ppm/°C (Note 18)

Over recommended operating conditions, unless otherwise specified. (Continued)

Parameter	Symbol	Test Conditions	Min (Note 20)	Typ (Note 7)	Max (Note 20)	Unit
Wiper Resistance	R_W	$V_{CC} = 3.3V$, wiper current $I_{RW} = V_{CC}/R_{TOTAL}$		130	400	W
V_{RH} and V_{RL} Terminal Voltages	V_{RH} , V_{RL}	V_{RH} and V_{RL} to GND	0		V_{CC}	V
Noise on Wiper Terminal		From 0Hz to 10MHz		-80		dBV
Potentiometer Capacitance (Note 19)	$C_H/C_L/C_W$			10/10/25		pF
Leakage on DCP Pins	I_{LkgDCP}	Voltage at pin from GND to V_{CC}		0.05	0.4	μA
Voltage Divider Mode (0V at R_L; V_{CC} at RH; measured at RW unloaded)						
Integral Non-Linearity	INL (Note 12)		-1		1	LSB (Note 8)
Differential Non-Linearity	DNL (Note 11)	Monotonic over all tap positions	-0.5		0.5	LSB (Note 8)
Zero-Scale Error	ZSerror (Note 9)		0	0.1	2	LSB (Note 8)
Full-Scale Error	FSerror (Note 10)		-2	-0.1	0	LSB (Note 8)
Ratiometric Temperature Coefficient	TC_V (Note 13)	Wiper from 5 hex to 1F hex		± 25		ppm/ $^{\circ}C$
3dB Cutoff Frequency	f_{CUTOFF}	Wiper at the middle scale		500		kHz
Resistor Mode (Measurements between RW and RL with RH not connected, or between RW and RH with RL not connected)						
Integral Non-Linearity	RINL (Note 17)	DCP register set between 1 hex and 1F hex; monotonic over all tap positions	-1.5		1.5	MI (Note 14)
Differential Non-Linearity	RDNL (Note 16)		-0.5		0.5	MI (Note 14)
Offset	Roffset (Note 15)	W option	0	1	2	MI (Note 14)

2.4.2 DC Electrical Specifications

Over recommended operating conditions unless otherwise specified.

Parameter	Symbol	Test Conditions	Min (Note 20)	Typ (Note 7)	Max (Note 20)	Unit
V_{CC} Active Current	I_{CC}	$V_{CC} = 5.5V$, perform wiper move operation			150	μA
V_{CC} Current During Store Operation	I_{CC}	$V_{CC} = 5.5V$, perform non-volatile store operation			2	mA
Standby Current	I_{SB}			0.6	3	μA
\overline{PU} , \overline{PD} Input Leakage Current	I_{Lkg}	$V_{IN} = V_{SS}$ to V_{CC}	-2		+2	μA
\overline{PU} , \overline{PD} Input HIGH Voltage	V_{IH}		$V_{CC} \times 0.7$			V
\overline{PU} , \overline{PD} input LOW Voltage	V_{IL}				$V_{CC} \times 0.1$	V
\overline{PU} , \overline{PD} Input Capacitance (Note 19)	C_{IN}	$V_{CC} = 3.3V$, $T_A = +25^{\circ}C$, $f = 1MHz$		10		pF
Pull-Up Resistor for \overline{PU} and \overline{PD} (Note 19)	R_{pull_up}			1		M Ω
EEPROM Specifications						
EEPROM Endurance			1000000			Cycles
EEPROM Retention		Temperature $\leq +55^{\circ}C$	50			Years

2.4.3 AC Electrical Specifications

Over recommended operating conditions unless otherwise specified.

Parameter	Symbol	Min (Note 20)	Typ (Note 7)	Max (Note 20)	Unit
Time Between Two Separate Push Button Events	t_{GAP}	2			ms
Debounce Time	t_{DB}		15	28	ms
Wiper Change on a Slow Mode	$t_{S\ SLOW}$	100	250	390	ms
Wiper Change on a Fast Mode	$t_{S\ FAST}$	25	50	78	ms
Time to Enter Shutdown Mode (keep \overline{PU} and \overline{PD} LOW) (Note 19)	t_{stdn}		2		s
Power-Up to Wiper Stable	t_{PU}			500	μ s
V_{CC} Power-Up Rate	$t_{R\ VCC}$	0.2		50	V/ms

Notes:

- Typical values are for $T_A = +25^\circ\text{C}$ and 3.3V supply voltage.
- LSB: $[V(RW)_{31} - V(RW)_0]/31$. $V(RW)_{31}$ and $V(RW)_0$ are the voltage on the RW pin for the DCP register set to 1F hex and 00 hex, respectively. LSB is the incremental voltage when changing from one tap to an adjacent tap.
- ZS error = $V(RW)_0/\text{LSB}$.
- FS error = $[V(RW)_{31} - V_{CC}]/\text{LSB}$.
- $\text{DNL} = [V(RW)_i - V(RW)_{i-1}]/\text{LSB} - 1$, for $i = 1$ to 31; i is the DCP register setting.
- $\text{INL} = [V(RW)_i - i \cdot \text{LSB} - V(RW)]/\text{LSB}$ for $i = 1$ to 31
- See [Equation 1](#).

$$\text{(EQ. 1)} \quad TC_V = \frac{\text{Max}(V(RW)_i) - \text{Min}(V(RW)_i)}{[\text{Max}(V(RW)_i) + \text{Min}(V(RW)_i)]/2} \times \frac{10^6}{+165^\circ\text{C}}$$

for $i = 5$ to 31 decimal, $T = -40^\circ\text{C}$ to $+125^\circ\text{C}$. $\text{Max}()$ is the maximum value of the wiper voltage and $\text{Min}()$ is the minimum value of the wiper voltage over the temperature range.

- $\text{MI} = |RW_{31} - RW_0|/31$. MI is a minimum increment. RW_{31} and RW_0 are the measured resistances for the DCP register set to 1F hex and 00 hex, respectively.
- $\text{Roffset} = RW_0/\text{MI}$ when measuring between RW and RL.
 $\text{Roffset} = RW_{31}/\text{MI}$ when measuring between RW and RH.
- $\text{RDNL} = (RW_i - RW_{i-1})/\text{MI}$ for $i = 1$ to 31.
- $\text{RINL} = [RW_i - (\text{MI} \cdot i) - RW_0]/\text{MI}$ for $i = 1$ to 31.
- See [Equation 2](#).

$$\text{(EQ. 2)} \quad TC_R = \frac{[\text{Max}(Ri) - \text{Min}(Ri)]}{[\text{Max}(Ri) + \text{Min}(Ri)]/2} \times \frac{10^6}{+165^\circ\text{C}}$$

for $i = 5$ to 31 decimal, $T = -40^\circ\text{C}$ to $+125^\circ\text{C}$. $\text{Max}()$ is the maximum value of the wiper voltage and $\text{Min}()$ is the minimum value of the resistance over the temperature range.

- Limits should be considered typical and are not production tested.
- Parameters with Min and/or Max limits are 100% tested at $+25^\circ\text{C}$, unless otherwise specified. Temperature limits established by characterization and are not production tested.

3. Timing Diagrams

3.1 Slow Mode Timing

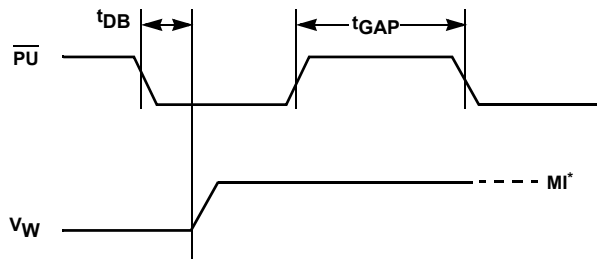

*MI is the minimum incremental change in the wiper voltage.

3.2 Fast Mode Timing

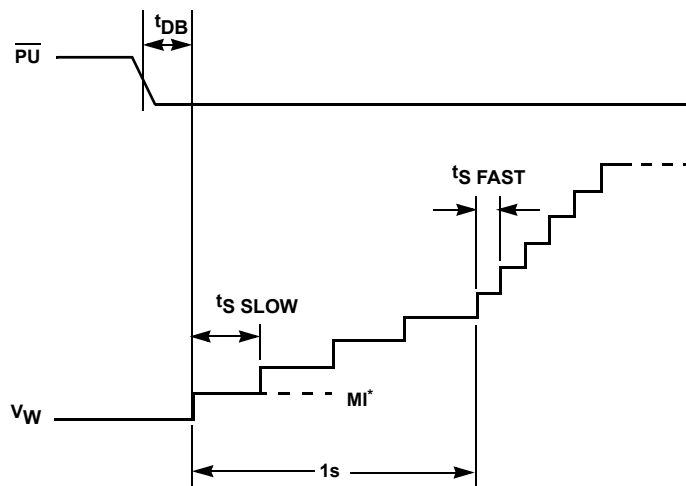

* MI is the minimum incremental change in the wiper voltage.

3.3 Shutdown Mode Timing

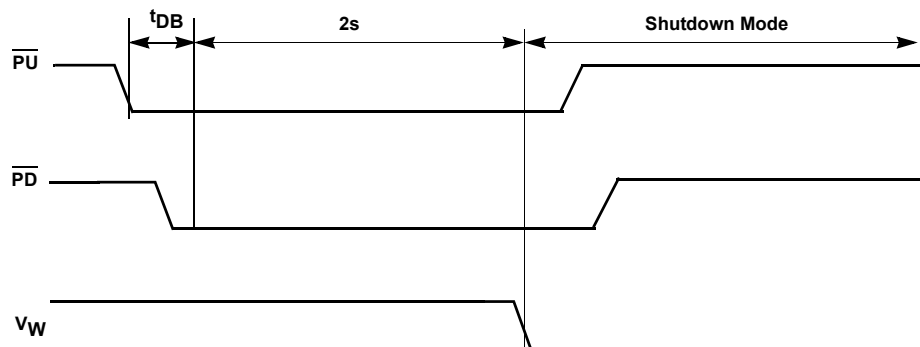

3.4 AUTOSTORE Mode Timing

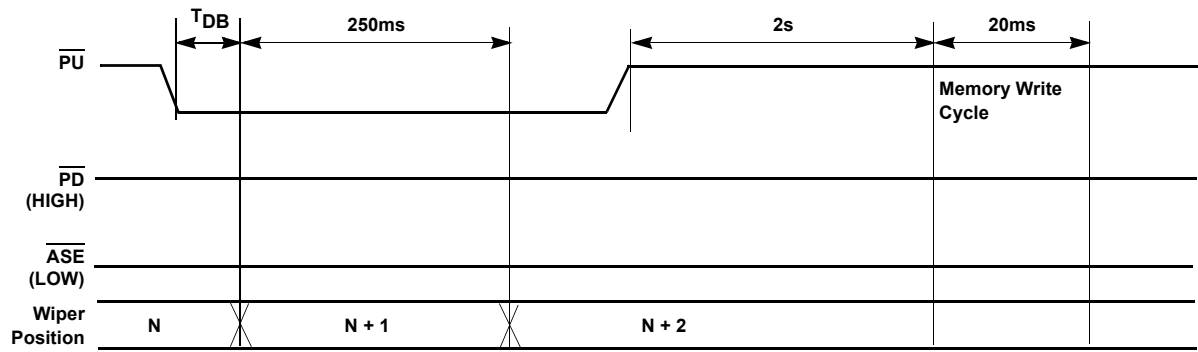

4. Typical Performance Curves

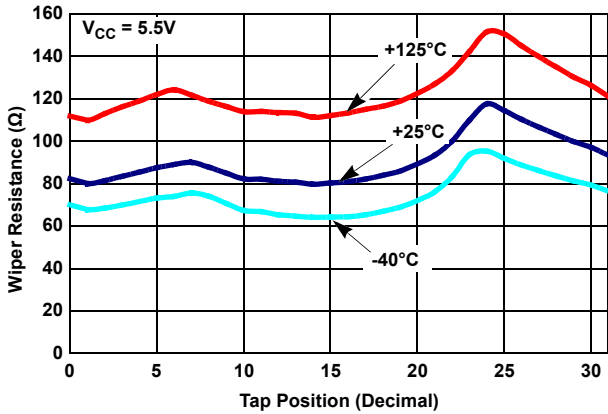

Figure 2. Wiper Resistance vs Tap Position
 $[I(RW) = V_{CC}/R_{TOTAL}]$ for 10kΩ

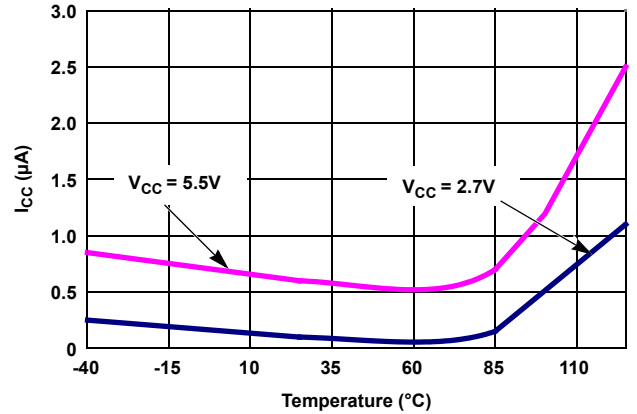

Figure 3. Standby I_{CC} vs Temperature

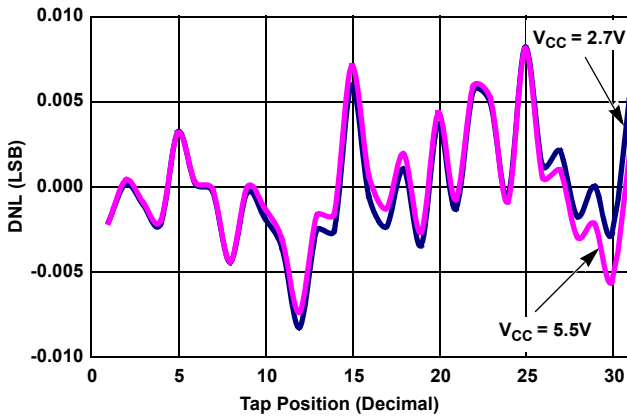

Figure 4. DNL vs Tap Position in Voltage Divider Mode for 10kΩ (W)

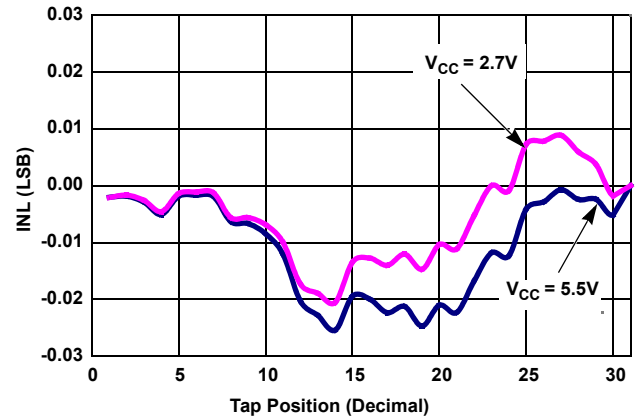

Figure 5. INL vs Tap Position in Voltage Divider Mode for 10kΩ (W)

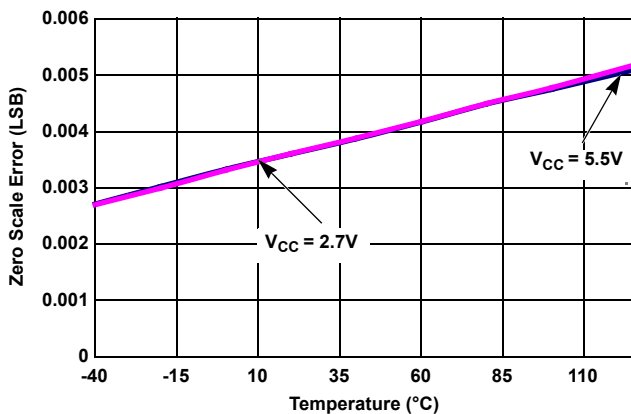

Figure 6. ZS Error vs Temperature

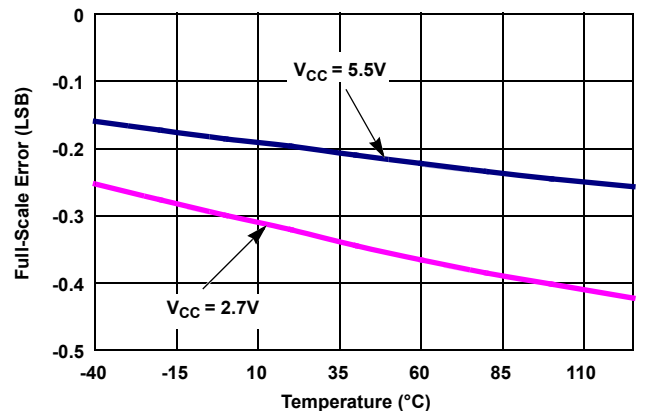

Figure 7. FS Error vs Temperature

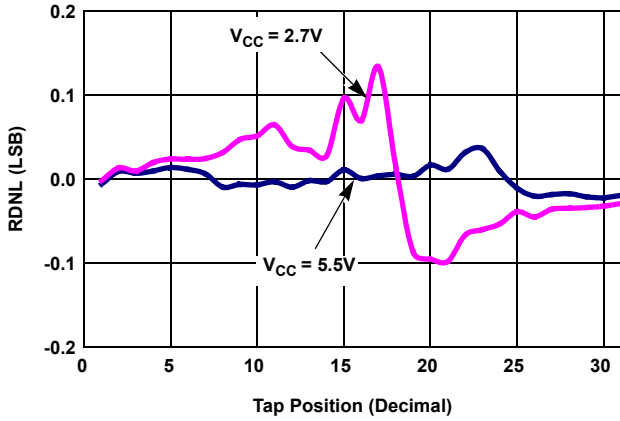

Figure 8. DNL vs Tap Position in Rheostat Mode for 10kΩ (Wiper)

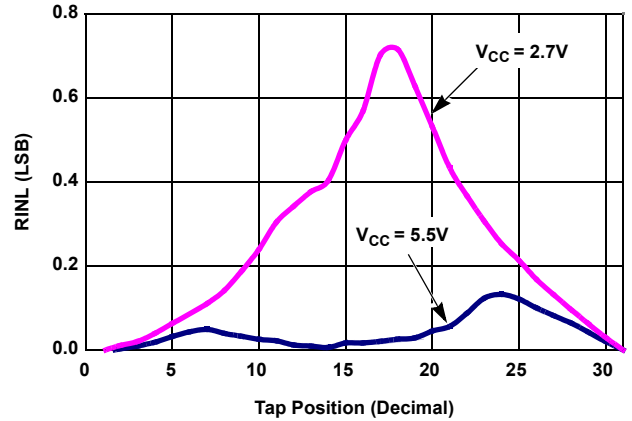

Figure 9. INL vs Tap Position in Rheostat Mode for 10kΩ (Wiper)

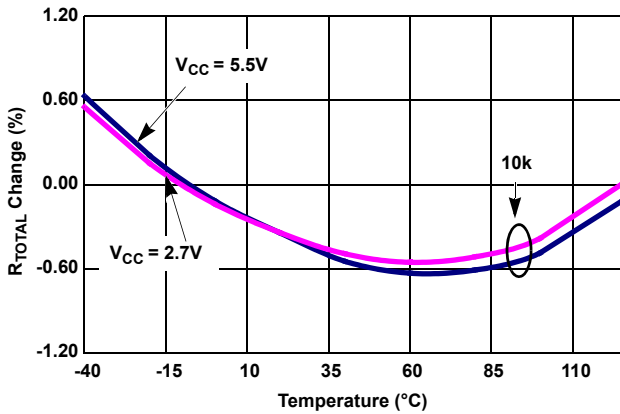

Figure 10. End to End R_{TOTAL} % Change vs Temperature

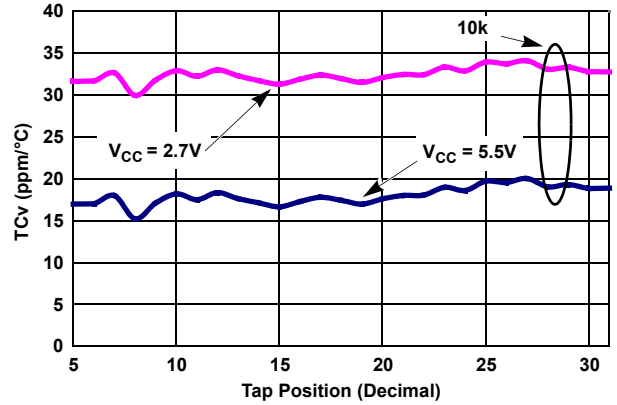

Figure 11. TC for Voltage Divider Mode

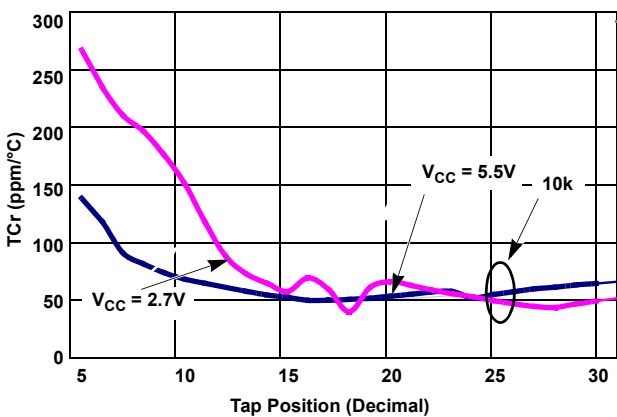

Figure 12. TC for Rheostat Mode in ppm

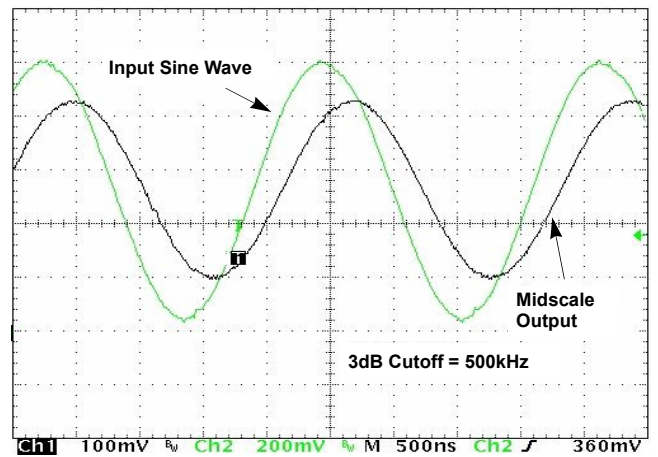

Figure 13. Frequency Response (500kHz)

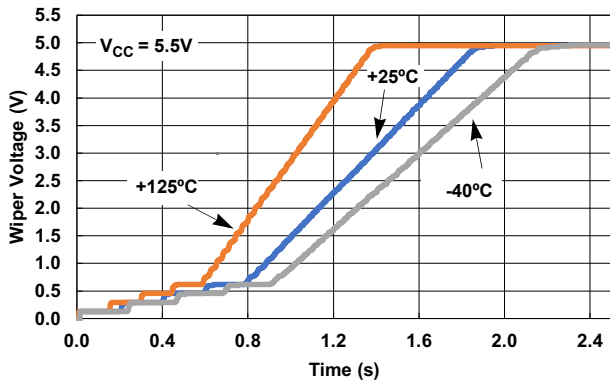

Figure 14. $\overline{\text{PU}}$ Continuously Held Low, Fast Mode Timing (n = 9)

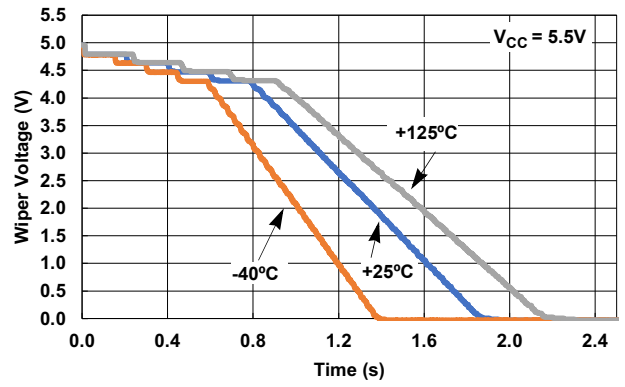

Figure 15. $\overline{\text{PD}}$ Continuously Held Low, Fast Mode Timing (n = 9)

5. Device Overview

5.1 Power-Up and Power-Down Requirements

There are no restrictions on the power-up or power-down conditions of V_{CC} and the voltages applied to the potentiometer pins if V_{CC} is always more positive than or equal to V_{RH} and V_{RL} . ($V_{CC} \geq V_{RH}, V_{RL}$). The V_{CC} ramp rate specification is always in effect.

5.2 Operating the Device

The ISL22511 consists of three sections:

- Input control, counter, and decode section
- EEPROM memory
- Resistor array

The input control section operates just like an up/down counter. The output of this counter is decoded to turn on a single electronic switch and connects a point on the resistor array to the wiper output. Under the proper conditions, the contents of the counter can be stored in EEPROM memory and retained for future use. The resistor array is comprised of 31 individual resistors connected in series. At either end of the array and between each resistor is an electronic switch that transfers the potential at that point to the wiper.

Note: The ISL22511 is programmed from the factory with the wiper set to the highest position: 0x1Fh.

The ISL22511 interfaces directly to two push button switches to effectively move the wiper up or down. The \overline{PU} input increments a 5-bit counter and the \overline{PD} input decrements a 5-bit counter. The output of this counter is decoded to select one of the 32 wiper positions along the resistive array. The wiper increment input (\overline{PU}) and the wiper decrement input (\overline{PD}) are both connected to an internal pull-up so that they normally remain HIGH. When pulled LOW by an external push button switch or a logic LOW level input, the wiper is switched to the next adjacent tap position.

Internal debounce circuitry prevents inadvertent switching of the wiper position if \overline{PU} or \overline{PD} remain LOW for less than 15ms, typical. Each of the buttons can be pushed either once for a single increment/decrement or continuously for multiple increments/decrements. The number of increments/decrements of the wiper position depends on how long the button is pushed. When making a continuous push, the increment/decrement speed increases after the first second. The device is in Slow Scan mode for the first second. If the button is held for longer than one second, the device goes into Fast Scan mode. The ISL22511 returns to the standby condition as soon as the button is released.

If two or more buttons are pressed simultaneously, all commands are ignored upon release of ALL buttons, except the Shutdown mode condition.

When the wiper is at either fixed terminal, it acts like its mechanical equivalent and does not move beyond the last position. That is, the counter does not wrap around when clocked to either extreme.

5.3 AUTOSTORE

The counter value is stored in EEPROM memory after two seconds of no activity on the \overline{PU} or \overline{PD} inputs while \overline{ASE} is enabled (held LOW). When power is restored, the content of the memory is recalled and the counter resets to the last value stored.

If AUTOSTORE is implemented, \overline{ASE} is typically hard-wired to VSS. If \overline{ASE} is held HIGH during power-up and then taken LOW, the wiper does not respond to the \overline{PU} or \overline{PD} inputs until \overline{ASE} is brought HIGH and held HIGH.

5.4 Manual (Push Button) Store

When \overline{ASE} is not enabled (held HIGH), a push button switch can be used to pull \overline{ASE} LOW for more than 15ms and released to perform a manual store of the wiper position.

Note: If \overline{ASE} is pulled LOW while either the \overline{PU} or \overline{PD} inputs are held LOW continuously, no store to the EEPROM occurs.

During memory write cycles, all inputs are ignored.

5.5 Shutdown Mode

The ISL22511 enters Shutdown mode if both the \overline{PU} and \overline{PD} inputs are kept LOW for two seconds. In Shutdown mode, the resistors array is totally disconnected from its RH pin and the wiper is moved to the position closest to the RL pin, as shown in [Figure 16](#).

Note: The \overline{PU} and \overline{PD} inputs must be pulled LOW within the t_{DB} time window of 15ms, otherwise, all commands are ignored until both inputs are released. See [“Shutdown Mode Timing” on page 7](#) for more information.

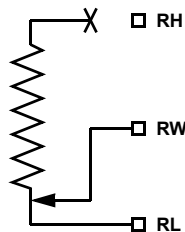

Figure 16. DCP Connection in Shutdown Mode

Holding either the \overline{PU} , \overline{PD} , or \overline{ASE} input LOW for more than 15ms causes the ISL22511 to exit Shutdown mode and return the wiper to the prior shutdown position. If \overline{PU} or \overline{PD} are held LOW for more than 250ms, the ISL22511 starts auto-incrementing or auto-decrementing the wiper position.

5.6 R_{TOTAL} with V_{CC} Removed

The end-to-end resistance of the array fluctuates when V_{CC} is removed.

6. Revision History

Rev.	Date	Description
3.00	May.13.19	<p>Applied new format.</p> <p>Updated ordering Information table by removing all 50k parts, adding tape and reel column, and updated notes.</p> <p>Added Related Literature section on page 1.</p> <p>Updated Figures 10, 11, and 12 removing the information for 50k parts.</p> <p>Removed all references to U option on page 5</p> <p>Added Figures 14 and 15 on page 11.</p> <p>Under Features Section changed "Middle Scale Wiper Position on Power-up" with "Max Scale Wiper Position on Power-Up".</p> <p>Under device overview in page 12 replace "Note the ISL22511 is programmed from the factory with the wiper set to RH tap" with "Note: The ISL22511 is programmed from the factory with the wiper set to the highest position 0x1Fh."</p>
2.00	Sep.9.15	<ul style="list-style-type: none"> - Ordering Information Table on page 2. - Added About Intersil section. - Updated POD L10.2.1X1.6A to latest revision changes are as follow: <ul style="list-style-type: none"> Updated to new POD format by removing table listing dimensions and moving dimensions onto drawing. Added Typical Recommended Land Pattern. Removed package option. - Updated POD M8.15 to latest revision changes are as follow: <ul style="list-style-type: none"> Changed Note 1 "1982" to "1994" Changed in Typical Recommended Land Pattern the following: <ul style="list-style-type: none"> 2.41(0.095) to 2.20(0.087) 0.76 (0.030) to 0.60(0.023) 0.200 to 5.20(0.205) Updated to new POD format by removing table and moving dimensions onto drawing and adding land pattern.
1.00	Jul.6.09	Added reliability information on page 1 under Features and EEPROM Specifications in DC Electrical Spec Table.
0.00	Mar.24.08	Initial release

7. Package Outline Drawings

For the most recent package outline drawing, see [L10.2.1x1.6A](#).

L10.2.1x1.6A
 10 Lead Ultra Thin Quad Flat No-Lead Plastic Package
 Rev 5, 3/10

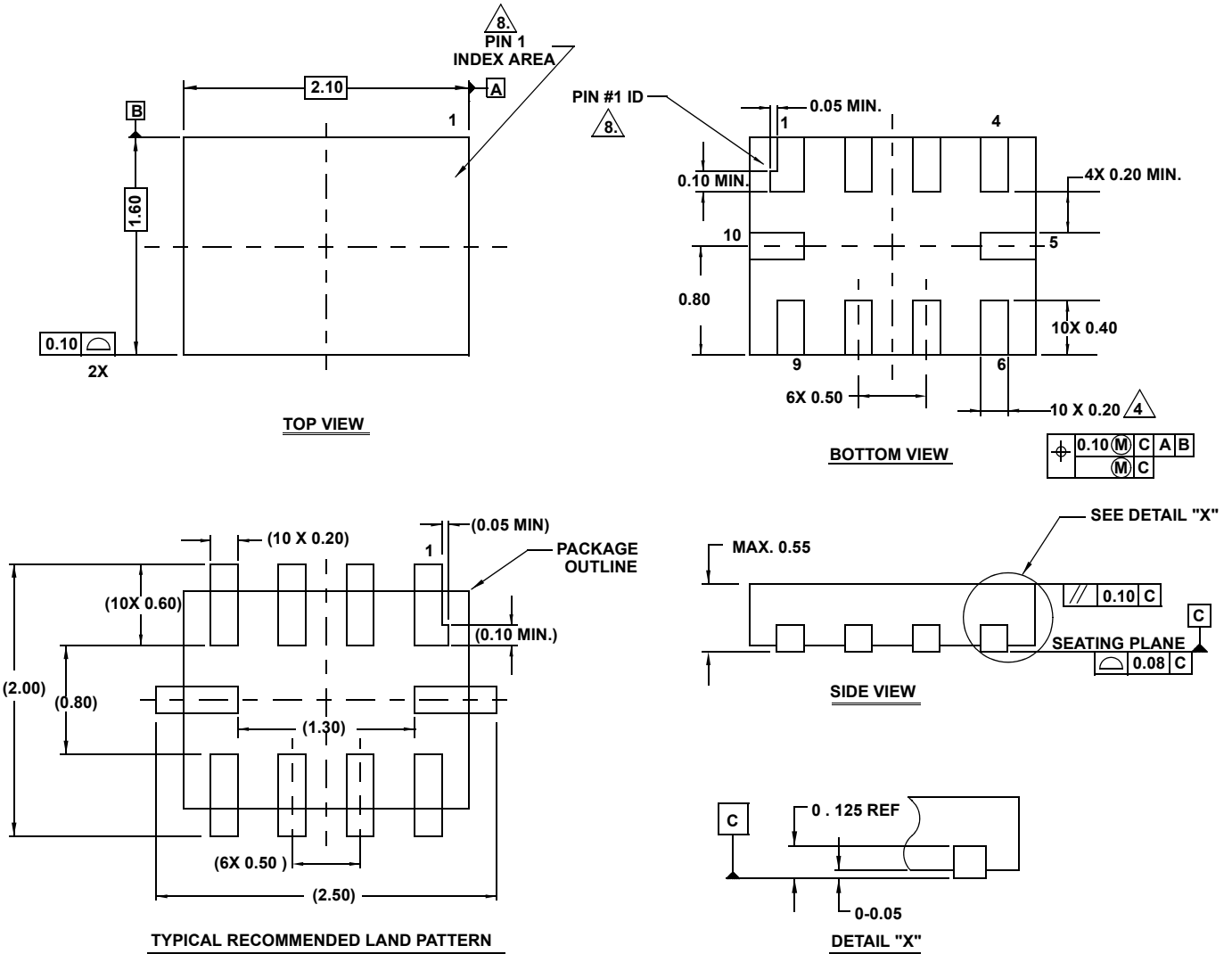

NOTES:

1. Dimensioning and tolerancing conform to ASME Y14.5M-1994.
2. All Dimensions are in millimeters. Angles are in degrees. Dimensions in () for Reference Only.
3. Unless otherwise specified, tolerance : Decimal ± 0.05
4. Lead width dimension applies to the metallized terminal and is measured between 0.15mm and 0.30mm from the terminal tip.
5. Maximum package warpage is 0.05mm.
6. Maximum allowable burrs is 0.076mm in all directions.
7. Same as JEDEC MO-255UABD except:
 No lead-pull-back, MIN. Package thickness = 0.45 not 0.50mm
 Lead Length dim. = 0.45mm max. not 0.42mm.
8. The configuration of the pin #1 identifier is optional, but must be located within the zone indicated. The pin #1 identifier may be either a mold or mark feature.

M8.15
 8 Lead Narrow Body Small Outline Plastic Package
 Rev 4, 1/12

For the most recent package outline drawing, see [M8.15](#).

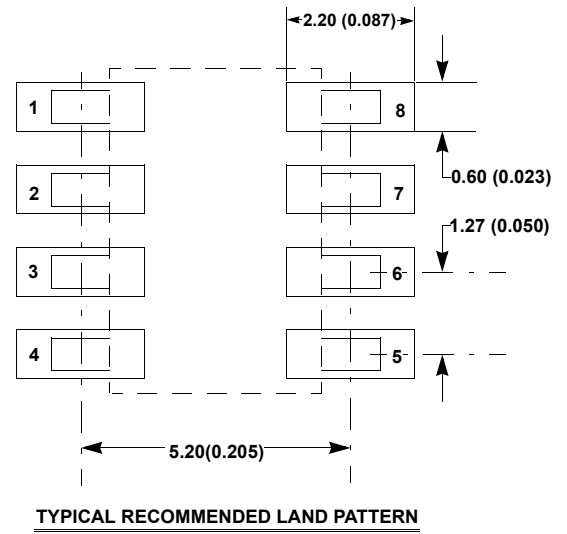
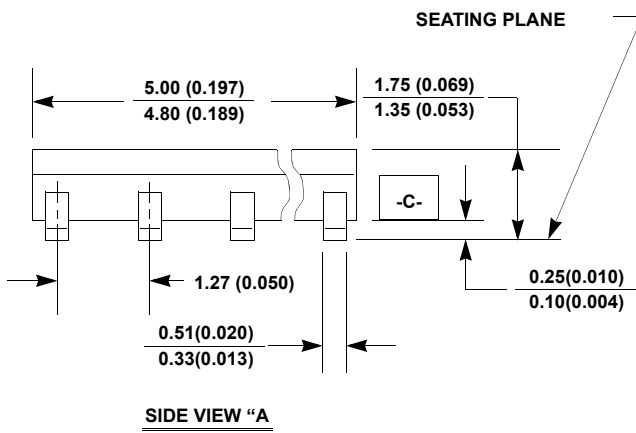
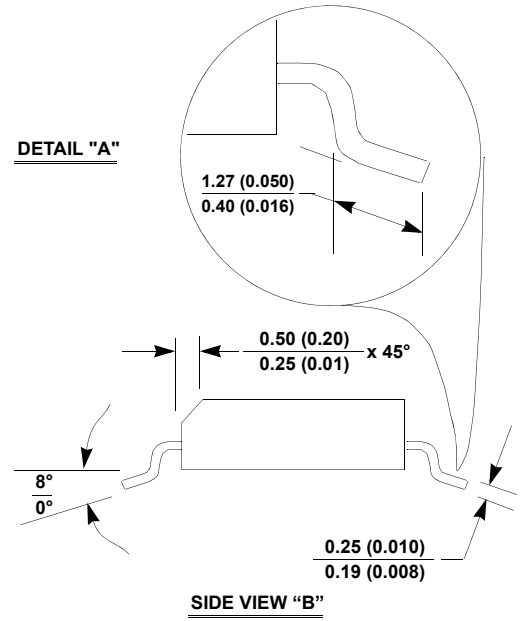
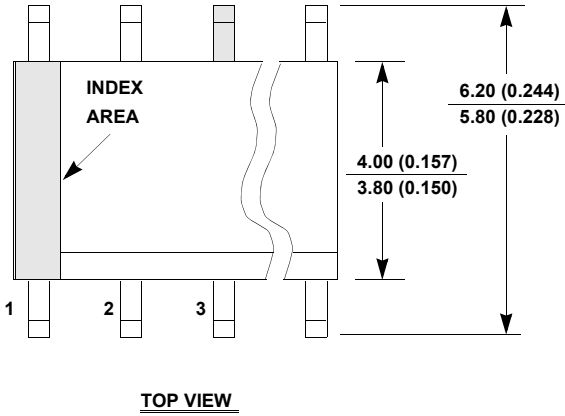

- NOTES:**
21. Dimensioning and tolerancing per ANSI Y14.5M-1994.
 22. Package length does not include mold flash, protrusions or gate burrs. Mold flash, protrusion and gate burrs shall not exceed 0.15mm (0.006 inch) per side.
 23. Package width does not include interlead flash or protrusions. Interlead flash and protrusions shall not exceed 0.25mm (0.010 inch) per side.
 24. The chamfer on the body is optional. If it is not present, a visual index feature must be located within the crosshatched area.
 25. Terminal numbers are shown for reference only.
 26. The lead width as measured 0.36mm (0.014 inch) or greater above the seating plane, shall not exceed a maximum value of 0.61mm (0.024 inch).
 27. Controlling dimension: MILLIMETER. Converted inch dimensions are not necessarily exact.
 28. This outline conforms to JEDEC publication MS-012-AA ISSUE C.

Notice

1. Descriptions of circuits, software and other related information in this document are provided only to illustrate the operation of semiconductor products and application examples. You are fully responsible for the incorporation or any other use of the circuits, software, and information in the design of your product or system. Renesas Electronics disclaims any and all liability for any losses and damages incurred by you or third parties arising from the use of these circuits, software, or information.
2. Renesas Electronics hereby expressly disclaims any warranties against and liability for infringement or any other claims involving patents, copyrights, or other intellectual property rights of third parties, by or arising from the use of Renesas Electronics products or technical information described in this document, including but not limited to, the product data, drawings, charts, programs, algorithms, and application examples.
3. No license, express, implied or otherwise, is granted hereby under any patents, copyrights or other intellectual property rights of Renesas Electronics or others.
4. You shall not alter, modify, copy, or reverse engineer any Renesas Electronics product, whether in whole or in part. Renesas Electronics disclaims any and all liability for any losses or damages incurred by you or third parties arising from such alteration, modification, copying or reverse engineering.
5. Renesas Electronics products are classified according to the following two quality grades: "Standard" and "High Quality". The intended applications for each Renesas Electronics product depends on the product's quality grade, as indicated below.
 - "Standard": Computers; office equipment; communications equipment; test and measurement equipment; audio and visual equipment; home electronic appliances; machine tools; personal electronic equipment; industrial robots; etc.
 - "High Quality": Transportation equipment (automobiles, trains, ships, etc.); traffic control (traffic lights); large-scale communication equipment; key financial terminal systems; safety control equipment; etc.Unless expressly designated as a high reliability product or a product for harsh environments in a Renesas Electronics data sheet or other Renesas Electronics document, Renesas Electronics products are not intended or authorized for use in products or systems that may pose a direct threat to human life or bodily injury (artificial life support devices or systems; surgical implantations; etc.), or may cause serious property damage (space system; undersea repeaters; nuclear power control systems; aircraft control systems; key plant systems; military equipment; etc.). Renesas Electronics disclaims any and all liability for any damages or losses incurred by you or any third parties arising from the use of any Renesas Electronics product that is inconsistent with any Renesas Electronics data sheet, user's manual or other Renesas Electronics document.
6. When using Renesas Electronics products, refer to the latest product information (data sheets, user's manuals, application notes, "General Notes for Handling and Using Semiconductor Devices" in the reliability handbook, etc.), and ensure that usage conditions are within the ranges specified by Renesas Electronics with respect to maximum ratings, operating power supply voltage range, heat dissipation characteristics, installation, etc. Renesas Electronics disclaims any and all liability for any malfunctions, failure or accident arising out of the use of Renesas Electronics products outside of such specified ranges.
7. Although Renesas Electronics endeavors to improve the quality and reliability of Renesas Electronics products, semiconductor products have specific characteristics, such as the occurrence of failure at a certain rate and malfunctions under certain use conditions. Unless designated as a high reliability product or a product for harsh environments in a Renesas Electronics data sheet or other Renesas Electronics document, Renesas Electronics products are not subject to radiation resistance design. You are responsible for implementing safety measures to guard against the possibility of bodily injury, injury or damage caused by fire, and/or danger to the public in the event of a failure or malfunction of Renesas Electronics products, such as safety design for hardware and software, including but not limited to redundancy, fire control and malfunction prevention, appropriate treatment for aging degradation or any other appropriate measures. Because the evaluation of microcomputer software alone is very difficult and impractical, you are responsible for evaluating the safety of the final products or systems manufactured by you.
8. Please contact a Renesas Electronics sales office for details as to environmental matters such as the environmental compatibility of each Renesas Electronics product. You are responsible for carefully and sufficiently investigating applicable laws and regulations that regulate the inclusion or use of controlled substances, including without limitation, the EU RoHS Directive, and using Renesas Electronics products in compliance with all these applicable laws and regulations. Renesas Electronics disclaims any and all liability for damages or losses occurring as a result of your noncompliance with applicable laws and regulations.
9. Renesas Electronics products and technologies shall not be used for or incorporated into any products or systems whose manufacture, use, or sale is prohibited under any applicable domestic or foreign laws or regulations. You shall comply with any applicable export control laws and regulations promulgated and administered by the governments of any countries asserting jurisdiction over the parties or transactions.
10. It is the responsibility of the buyer or distributor of Renesas Electronics products, or any other party who distributes, disposes of, or otherwise sells or transfers the product to a third party, to notify such third party in advance of the contents and conditions set forth in this document.
11. This document shall not be reprinted, reproduced or duplicated in any form, in whole or in part, without prior written consent of Renesas Electronics.
12. Please contact a Renesas Electronics sales office if you have any questions regarding the information contained in this document or Renesas Electronics products.

(Note1) "Renesas Electronics" as used in this document means Renesas Electronics Corporation and also includes its directly or indirectly controlled subsidiaries.

(Note2) "Renesas Electronics product(s)" means any product developed or manufactured by or for Renesas Electronics.

(Rev.4.0-1 November 2017)

Corporate Headquarters

TOYOSU FORESIA, 3-2-24 Toyosu,
Koto-ku, Tokyo 135-0061, Japan
www.renesas.com

Contact Information

For further information on a product, technology, the most up-to-date version of a document, or your nearest sales office, please visit:
www.renesas.com/contact/

Trademarks

Renesas and the Renesas logo are trademarks of Renesas Electronics Corporation. All trademarks and registered trademarks are the property of their respective owners.