

**FEATURES**

**Nominal resistor tolerance error:  $\pm 8\%$  maximum**  
**Wiper current:  $\pm 6$  mA**  
**Rheostat mode temperature coefficient: 35 ppm/ $^{\circ}$ C**  
**Low power consumption: 2.5  $\mu$ A max @ 2.7 V and 125 $^{\circ}$ C**  
**Wide bandwidth: 4 MHz (5 k $\Omega$  option)**  
**Power-on EEPROM refresh time < 50  $\mu$ s**  
**50-year typical data retention at 125 $^{\circ}$ C**  
**1 million write cycles**  
**2.3 V to 5.5 V supply operation**  
**Chip select enable multiple device operation**  
**Wide operating temperature:  $-40^{\circ}$ C to  $+125^{\circ}$ C**  
**Thin, 2 mm  $\times$  2 mm  $\times$  0.55 mm 8-lead LFCSP package**

**APPLICATIONS**

**Mechanical potentiometer replacement**  
**Portable electronics level adjustment**  
**Audio volume control**  
**Low resolution DAC**  
**LCD panel brightness and contrast control**  
**Programmable voltage to current conversion**  
**Programmable filters, delays, time constants**  
**Feedback resistor programmable power supply**  
**Sensor calibration**

**GENERAL DESCRIPTION**

The AD5111/AD5113/AD5115 provide a nonvolatile solution for 128-/64-/32-position adjustment applications, offering guaranteed low resistor tolerance errors of  $\pm 8\%$  and up to  $\pm 6$  mA current density in the A, B, and W pins. The low resistor tolerance, low nominal temperature coefficient, and high bandwidth simplify open-loop applications, as well as tolerance matching applications.

**FUNCTIONAL BLOCK DIAGRAM**

Figure 1.

 Table 1.  $\pm 8\%$  Resistance Tolerance Family

Model	Resistance (k $\Omega$ )	Position	Interface
AD5110	10, 80	128	I <sup>2</sup> C
AD5111	10, 80	128	Up/down
AD5112	5, 10, 80	64	I <sup>2</sup> C
AD5113	5, 10, 80	64	Up/down
AD5116	5, 10, 80	64	Push-button
AD5114	10, 80	32	I <sup>2</sup> C
AD5115	10, 80	32	Up/down

The new low wiper resistance feature minimizes the wiper resistance in the extremes of the resistor array to only 45  $\Omega$ , typical.

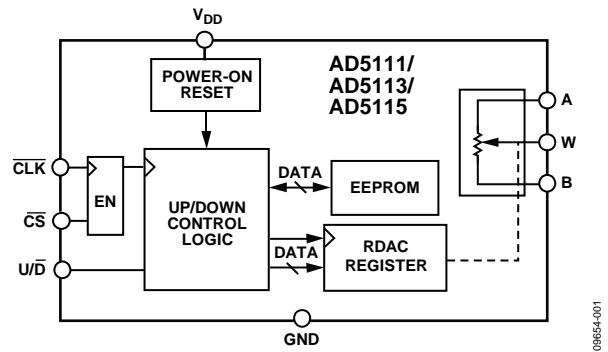
A simple 3-wire up/down interface allows manual switching or high speed digital control with clock rates up to 50 MHz.

The AD5111/AD5113/AD5115 are available in a 2 mm  $\times$  2 mm LFCSP package. The parts are guaranteed to operate over the extended industrial temperature range of  $-40^{\circ}$ C to  $+125^{\circ}$ C.

## TABLE OF CONTENTS

Features .....	1	Test Circuits.....	17
Applications.....	1	Theory of Operation .....	18
Functional Block Diagram .....	1	RDAC Register and EEPROM.....	18
General Description .....	1	Basic Operation .....	18
Revision History .....	2	Low Wiper Resistance Feature .....	18
Specifications.....	3	Shutdown Mode .....	18
Electrical Characteristics—AD5111 .....	3	EEPROM Write Operation .....	18
Electrical Characteristics—AD5113 .....	5	RDAC Architecture.....	19
Electrical Characteristics—AD5115 .....	7	Programming the Variable Resistor.....	19
Interface Timing Specifications.....	9	Programming the Potentiometer Divider.....	20
Timing Diagram .....	9	Terminal Voltage Operating Range .....	20
Absolute Maximum Ratings.....	10	Power-Up Sequence .....	21
Thermal Resistance .....	10	Layout and Power Supply Biasing.....	21
ESD Caution.....	10	Outline Dimensions .....	22
Pin Configuration and Function Descriptions.....	11	Ordering Guide .....	22
Typical Performance Characteristics .....	12		

## REVISION HISTORY

### 11/12—Rev. A to Rev. B

Changed Low Power Consumption from 2.5 mA to 2.5 $\mu$ A.....	1
Changed $I_{DD}$ Unit from mA to $\mu$ A, Table 2.....	3
Changed $I_{DD}$ Unit from mA to $\mu$ A, Table 3.....	5
Changed $I_{DD}$ Unit from mA to $\mu$ A, Table 4.....	7

### 4/12—Rev. 0 to Rev. A

Changes to Features Section.....	1
Changes to Positive Supply Current, Table 2 .....	3
Changes to Positive Supply Current, Table 3 .....	5
Changes to Positive Supply Current, Table 4 .....	7
Updated Outline Dimensions .....	22

### 10/11—Revision 0: Initial Version

## SPECIFICATIONS

## ELECTRICAL CHARACTERISTICS—AD5111

10 k $\Omega$  and 80 k $\Omega$  versions:  $V_{DD} = 2.3 \text{ V to } 5.5 \text{ V}$ ,  $V_A = V_{DD}$ ,  $V_B = 0 \text{ V}$ ,  $-40^\circ\text{C} < T_A < +125^\circ\text{C}$ , unless otherwise noted.

Table 2.

Parameter	Symbol	Test Conditions/Comments	Min	Typ <sup>1</sup>	Max	Unit
DC CHARACTERISTICS—RHEOSTAT MODE						
Resolution	N		7			Bits
Resistor Integral Nonlinearity <sup>2</sup>	R-INL	$R_{AB} = 10 \text{ k}\Omega$ , $V_{DD} = 2.3 \text{ V to } 2.7 \text{ V}$	-2.5	$\pm 0.5$	+2.5	LSB
		$R_{AB} = 10 \text{ k}\Omega$ , $V_{DD} = 2.7 \text{ V to } 5.5 \text{ V}$	-1	$\pm 0.25$	+1	LSB
		$R_{AB} = 80 \text{ k}\Omega$	-0.5	$\pm 0.1$	+0.5	LSB
Resistor Differential Nonlinearity <sup>2</sup>	R-DNL		-1	$\pm 0.25$	+1	LSB
Nominal Resistor Tolerance	$\Delta R_{AB}/R_{AB}$		-8		+8	%
Resistance Temperature Coefficient <sup>3</sup>	$(\Delta R_{AB}/R_{AB})/\Delta T \times 10^6$			35		ppm/ $^\circ\text{C}$
Wiper Resistance	$R_W$	Code = zero scale		70	140	$\Omega$
	$R_{BS}$	Code = bottom scale		45	80	$\Omega$
	$R_{TS}$	Code = top scale		70	140	$\Omega$
DC CHARACTERISTICS—POTENTIOMETER DIVIDER MODE						
Integral Nonlinearity <sup>4</sup>	INL		-0.5	$\pm 0.15$	+0.5	LSB
Differential Nonlinearity <sup>4</sup>	DNL		-0.5	$\pm 0.15$	+0.5	LSB
Full-Scale Error	$V_{WFSE}$	$R_{AB} = 10 \text{ k}\Omega$	-2.5			LSB
		$R_{AB} = 80 \text{ k}\Omega$	-1.5			LSB
Zero-Scale Error	$V_{WZSE}$	$R_{AB} = 10 \text{ k}\Omega$			1.5	LSB
		$R_{AB} = 80 \text{ k}\Omega$			0.5	LSB
Voltage Divider Temperature Coefficient <sup>3</sup>	$(\Delta V_W/V_W)/\Delta T \times 10^6$	Code = half scale		$\pm 10$		ppm/ $^\circ\text{C}$
RESISTOR TERMINALS						
Maximum Continuous $I_A$ , $I_B$ , and $I_W$ Current <sup>3</sup>		$R_{AB} = 10 \text{ k}\Omega$	-6		+6	mA
		$R_{AB} = 80 \text{ k}\Omega$	-1.5		+1.5	mA
Terminal Voltage Range <sup>5</sup>			GND		$V_{DD}$	V
Capacitance A, Capacitance B <sup>3,6</sup>	$C_A$ , $C_B$	f = 1 MHz, measured to GND, code = half scale		20		pF
Capacitance W <sup>3,6</sup>	$C_W$	f = 1 MHz, measured to GND, code = half scale		35		pF
Common-Mode Leakage Current <sup>3</sup>		$V_A = V_W = V_B$	-500	$\pm 15$	+500	nA
DIGITAL INPUTS						
Input Logic <sup>3</sup>						
High	$V_{INH}$		2			V
Low	$V_{INL}$				0.8	V
Input Current <sup>3</sup>	$I_N$				$\pm 1$	$\mu\text{A}$
Input Capacitance <sup>3</sup>	$C_{IN}$			5		pF
POWER SUPPLIES						
Single-Supply Power Range			2.3		5.5	V
Positive Supply Current	$I_{DD}$	$V_{IH} = V_{DD}$ or $V_{IL} = \text{GND}$ , $V_{DD} = 5 \text{ V}$		0.75	3.5	$\mu\text{A}$
		$V_{IH} = V_{DD}$ or $V_{IL} = \text{GND}$ , $V_{DD} = 2.7 \text{ V}$			2.5	$\mu\text{A}$
		$V_{IH} = V_{DD}$ or $V_{IL} = \text{GND}$ , $V_{DD} = 2.3 \text{ V}$			2.4	$\mu\text{A}$
EEMEM Store Current <sup>3,7</sup>	$I_{DD\_NVM\_STORE}$			2		mA
EEMEM Read Current <sup>3,8</sup>	$I_{DD\_NVM\_READ}$			320		$\mu\text{A}$
Power Dissipation <sup>9</sup>	$P_{DISS}$	$V_{IH} = V_{DD}$ or $V_{IL} = \text{GND}$		5		$\mu\text{W}$
Power Supply Rejection <sup>3</sup>	PSR	$\Delta V_{DD}/\Delta V_{SS} = 5 \text{ V} \pm 10\%$				
		$R_{AB} = 10 \text{ k}\Omega$			-50	dB
		$R_{AB} = 80 \text{ k}\Omega$			-64	dB

Parameter	Symbol	Test Conditions/Comments	Min	Typ <sup>1</sup>	Max	Unit
DYNAMIC CHARACTERISTICS <sup>3, 10</sup>						
Bandwidth	BW	Code = half scale, -3 dB $R_{AB} = 10\text{ k}\Omega$ $R_{AB} = 80\text{ k}\Omega$		2 200		MHz kHz
Total Harmonic Distortion	THD	$V_A = V_{DD}/2 + 1\text{ V rms}$ , $V_B = V_{DD}/2$ , $f = 1\text{ kHz}$ , code = half scale $R_{AB} = 10\text{ k}\Omega$ $R_{AB} = 80\text{ k}\Omega$		-80 -85		dB dB
$V_W$ Settling Time	$t_s$	$V_A = 5\text{ V}$ , $V_B = 0\text{ V}$ , $\pm 0.5\text{ LSB}$ error band $R_{AB} = 10\text{ k}\Omega$ $R_{AB} = 80\text{ k}\Omega$		3 12		$\mu\text{s}$ $\mu\text{s}$
Resistor Noise Density	$e_{N\_WB}$	Code = half scale, $T_A = 25^\circ\text{C}$ , $f = 100\text{ kHz}$ $R_{AB} = 10\text{ k}\Omega$ $R_{AB} = 80\text{ k}\Omega$		9 20		nV/ $\sqrt{\text{Hz}}$ nV/ $\sqrt{\text{Hz}}$
FLASH/EE MEMORY RELIABILITY <sup>3</sup>						
Endurance <sup>11</sup>		$T_A = 25^\circ\text{C}$		1		MCycles
Data Retention <sup>12</sup>			100	50		kCycles Years

<sup>1</sup> Typical values represent average readings at  $25^\circ\text{C}$ ,  $V_{DD} = 5\text{ V}$ ,  $V_{SS} = 0\text{ V}$ , and  $V_{LOGIC} = 5\text{ V}$ .

<sup>2</sup> R-INL is the deviation from an ideal value measured between the maximum resistance and the minimum resistance wiper positions. R-DNL measures the relative step change from ideal between successive tap positions. The maximum wiper current is limited to  $0.8 \times V_{DD}/R_{AB}$ .

<sup>3</sup> Guaranteed by design and characterization; not subject to production test.

<sup>4</sup> INL and DNL are measured at  $V_{WB}$  with the RDAC configured as a potentiometer divider similar to a voltage output DAC.  $V_A = V_{DD}$  and  $V_B = 0\text{ V}$ . DNL specification limits of  $\pm 1\text{ LSB}$  maximum are guaranteed monotonic operating conditions.

<sup>5</sup> Resistor Terminal A, Resistor Terminal B, and Resistor Terminal W have no limitations on current direction with respect to each other.

<sup>6</sup>  $C_A$  is measured with  $V_W = V_A = 2.5\text{ V}$ ,  $C_B$  is measured with  $V_W = V_B = 2.5\text{ V}$ , and  $C_W$  is measured with  $V_A = V_B = 2.5\text{ V}$ .

<sup>7</sup> Different from operating current; supply current for NVM program lasts approximately 30 ms.

<sup>8</sup> Different from operating current; supply current for NVM read lasts approximately 20  $\mu\text{s}$ .

<sup>9</sup>  $P_{DISS}$  is calculated from  $(I_{DD} \times V_{DD})$ .

<sup>10</sup> All dynamic characteristics use  $V_{DD} = 5.5\text{ V}$  and  $V_{LOGIC} = 5\text{ V}$ .

<sup>11</sup> Endurance is qualified at 100,000 cycles per JEDEC Standard 22, Method A117 and measured at  $150^\circ\text{C}$ .

<sup>12</sup> Retention lifetime equivalent at junction temperature ( $T_J$ ) is  $125^\circ\text{C}$  per JEDEC Standard 22, Method A117. Retention lifetime based on an activation energy of 1 eV derates with junction temperature in the Flash/EE memory.

**ELECTRICAL CHARACTERISTICS—AD5113**

5 k $\Omega$ , 10 k $\Omega$ , and 80 k $\Omega$  versions:  $V_{DD} = 2.3 \text{ V to } 5.5 \text{ V}$ ,  $V_A = V_{DD}$ ,  $V_B = 0 \text{ V}$ ,  $-40^\circ\text{C} < T_A < +125^\circ\text{C}$ , unless otherwise noted.

**Table 3.**

Parameter	Symbol	Test Conditions/Comments	Min	Typ <sup>1</sup>	Max	Unit
<b>DC CHARACTERISTICS—RHEOSTAT MODE</b>						
Resolution	N		6			Bits
Resistor Integral Nonlinearity <sup>2</sup>	R-INL	$R_{AB} = 5 \text{ k}\Omega$ , $V_{DD} = 2.3 \text{ V to } 2.7 \text{ V}$	-2.5	$\pm 0.5$	+2.5	LSB
		$R_{AB} = 5 \text{ k}\Omega$ , $V_{DD} = 2.7 \text{ V to } 5.5 \text{ V}$	-1	$\pm 0.25$	+1	LSB
		$R_{AB} = 10 \text{ k}\Omega$	-1	$\pm 0.25$	+1	LSB
		$R_{AB} = 80 \text{ k}\Omega$	-0.25	$\pm 0.1$	+0.25	LSB
Resistor Differential Nonlinearity <sup>2</sup>	R-DNL		-1	$\pm 0.25$	+1	LSB
Nominal Resistor Tolerance	$\Delta R_{AB}/R_{AB}$		-8		+8	%
Resistance Temperature Coefficient <sup>3</sup>	$(\Delta R_{AB}/R_{AB})/\Delta T \times 10^6$			35		ppm/ $^\circ\text{C}$
Wiper Resistance	$R_W$	Code = zero scale		70	140	$\Omega$
	$R_{BS}$	Code = bottom scale		45	80	$\Omega$
	$R_{TS}$	Code = top scale		70	140	$\Omega$
<b>DC CHARACTERISTICS—POTENTIOMETER DIVIDER MODE</b>						
Integral Nonlinearity <sup>4</sup>	INL		-0.5	$\pm 0.15$	+0.5	LSB
Differential Nonlinearity <sup>4</sup>	DNL		-0.5	$\pm 0.15$	+0.5	LSB
Full-Scale Error	$V_{WFSE}$	$R_{AB} = 5 \text{ k}\Omega$	-2.5			LSB
		$R_{AB} = 10 \text{ k}\Omega$	-1.5			LSB
		$R_{AB} = 80 \text{ k}\Omega$	-1			LSB
Zero-Scale Error	$V_{WZSE}$	$R_{AB} = 5 \text{ k}\Omega$			1.5	LSB
		$R_{AB} = 10 \text{ k}\Omega$			1	LSB
		$R_{AB} = 80 \text{ k}\Omega$			0.25	LSB
Voltage Divider Temperature Coefficient <sup>3</sup>	$(\Delta V_W/V_W)/\Delta T \times 10^6$	Code = half scale		$\pm 10$		ppm/ $^\circ\text{C}$
<b>RESISTOR TERMINALS</b>						
Maximum Continuous $I_A$ , $I_B$ , and $I_W$ Current <sup>3</sup>		$R_{AB} = 5 \text{ k}\Omega$ , 10 k $\Omega$	-6		+6	mA
		$R_{AB} = 80 \text{ k}\Omega$	-1.5		+1.5	mA
Terminal Voltage Range <sup>5</sup>			GND		$V_{DD}$	V
Capacitance A, Capacitance B <sup>3,6</sup>	$C_A$ , $C_B$	f = 1 MHz, measured to GND, code = half scale		20		pF
Capacitance W <sup>3,6</sup>	$C_W$	f = 1 MHz, measured to GND, code = half scale		35		pF
Common-Mode Leakage Current <sup>3</sup>		$V_A = V_W = V_B$	-500	$\pm 15$	+500	nA
<b>DIGITAL INPUTS</b>						
Input Logic <sup>3</sup>						
High	$V_{INH}$		2			V
Low	$V_{INL}$				0.8	V
Input Current <sup>3</sup>	$I_N$				$\pm 1$	$\mu\text{A}$
Input Capacitance <sup>3</sup>	$C_{IN}$			5		pF
<b>POWER SUPPLIES</b>						
Single-Supply Power Range			2.3		5.5	V
Positive Supply Current	$I_{DD}$	$V_{IH} = V_{DD}$ or $V_{IL} = \text{GND}$ , $V_{DD} = 5 \text{ V}$		0.75	3.5	$\mu\text{A}$
		$V_{IH} = V_{DD}$ or $V_{IL} = \text{GND}$ , $V_{DD} = 2.7 \text{ V}$			2.5	$\mu\text{A}$
		$V_{IH} = V_{DD}$ or $V_{IL} = \text{GND}$ , $V_{DD} = 2.3 \text{ V}$			2.4	$\mu\text{A}$
EEMEM Store Current <sup>3,7</sup>	$I_{DD\_NVM\_STORE}$			2		mA
EEMEM Read Current <sup>3,8</sup>	$I_{DD\_NVM\_READ}$			320		$\mu\text{A}$
Power Dissipation <sup>9</sup>	$P_{DISS}$	$V_{IH} = V_{DD}$ or $V_{IL} = \text{GND}$		5		$\mu\text{W}$
Power Supply Rejection <sup>3</sup>	PSR	$\Delta V_{DD}/\Delta V_{SS} = 5 \text{ V} \pm 10\%$				
		$R_{AB} = 5 \text{ k}\Omega$			-43	dB
		$R_{AB} = 10 \text{ k}\Omega$			-50	dB
		$R_{AB} = 80 \text{ k}\Omega$			-64	dB

Parameter	Symbol	Test Conditions/Comments	Min	Typ <sup>1</sup>	Max	Unit
DYNAMIC CHARACTERISTICS <sup>3, 10</sup>						
Bandwidth	BW	Code = half scale, -3 dB				
		$R_{AB} = 5 \text{ k}\Omega$		4		MHz
		$R_{AB} = 10 \text{ k}\Omega$		2		MHz
Total Harmonic Distortion	THD	$R_{AB} = 80 \text{ k}\Omega$		200		kHz
		$V_A = V_{DD}/2 + 1 \text{ V rms}$ , $V_B = V_{DD}/2$ , $f = 1 \text{ kHz}$ , code = half scale				
		$R_{AB} = 5 \text{ k}\Omega$		-75		dB
$V_W$ Settling Time	$t_s$	$R_{AB} = 10 \text{ k}\Omega$				dB
		$R_{AB} = 80 \text{ k}\Omega$				dB
		$V_A = 5 \text{ V}$ , $V_B = 0 \text{ V}$ , $\pm 0.5 \text{ LSB error band}$				
Resistor Noise Density	$e_{N\_WB}$	$R_{AB} = 5 \text{ k}\Omega$		2.5		$\mu\text{s}$
		$R_{AB} = 10 \text{ k}\Omega$		3		$\mu\text{s}$
		$R_{AB} = 80 \text{ k}\Omega$		10		$\mu\text{s}$
FLASH/EE MEMORY RELIABILITY <sup>3</sup>		Code = half scale, $T_A = 25^\circ\text{C}$ , $f = 100 \text{ kHz}$				
		$R_{AB} = 5 \text{ k}\Omega$		7		nV/ $\sqrt{\text{Hz}}$
		$R_{AB} = 10 \text{ k}\Omega$		9		nV/ $\sqrt{\text{Hz}}$
Endurance <sup>11</sup>		$T_A = 25^\circ\text{C}$		1		MCycles
			100			kCycles
Data Retention <sup>12</sup>				50		Years

<sup>1</sup> Typical values represent average readings at  $25^\circ\text{C}$ ,  $V_{DD} = 5 \text{ V}$ ,  $V_{SS} = 0 \text{ V}$ , and  $V_{LOGIC} = 5 \text{ V}$ .

<sup>2</sup> R-INL is the deviation from an ideal value measured between the maximum resistance and the minimum resistance wiper positions. R-DNL measures the relative step change from ideal between successive tap positions. The maximum wiper current is limited to  $0.8 \times V_{DD}/R_{AB}$ .

<sup>3</sup> Guaranteed by design and characterization; not subject to production test.

<sup>4</sup> INL and DNL are measured at  $V_{WB}$  with the RDAC configured as a potentiometer divider similar to a voltage output DAC.  $V_A = V_{DD}$  and  $V_B = 0 \text{ V}$ . DNL specification limits of  $\pm 1 \text{ LSB}$  maximum are guaranteed monotonic operating conditions.

<sup>5</sup> Resistor Terminal A, Resistor Terminal B, and Resistor Terminal W have no limitations on current direction with respect to each other.

<sup>6</sup>  $C_A$  is measured with  $V_W = V_A = 2.5 \text{ V}$ ,  $C_B$  is measured with  $V_W = V_B = 2.5 \text{ V}$ , and  $C_W$  is measured with  $V_A = V_B = 2.5 \text{ V}$ .

<sup>7</sup> Different from operating current; supply current for NVM program lasts approximately 30 ms.

<sup>8</sup> Different from operating current; supply current for NVM read lasts approximately 20  $\mu\text{s}$ .

<sup>9</sup>  $P_{DISS}$  is calculated from  $(I_{DD} \times V_{DD})$ .

<sup>10</sup> All dynamic characteristics use  $V_{DD} = 5.5 \text{ V}$  and  $V_{LOGIC} = 5 \text{ V}$ .

<sup>11</sup> Endurance is qualified at 100,000 cycles per JEDEC Standard 22, Method A117 and measured at  $150^\circ\text{C}$ .

<sup>12</sup> Retention lifetime equivalent at junction temperature ( $T_J$ ) is  $125^\circ\text{C}$  per JEDEC Standard 22, Method A117. Retention lifetime based on an activation energy of 1 eV derates with junction temperature in the Flash/EE memory.

**ELECTRICAL CHARACTERISTICS—AD5115**

10 k $\Omega$  and 80 k $\Omega$  versions:  $V_{DD} = 2.3 \text{ V to } 5.5 \text{ V}$ ,  $V_A = V_{DD}$ ,  $V_B = 0 \text{ V}$ ,  $-40^\circ\text{C} < T_A < +125^\circ\text{C}$ , unless otherwise noted.

**Table 4.**

Parameter	Symbol	Test Conditions/Comments	Min	Typ <sup>1</sup>	Max	Unit
<b>DC CHARACTERISTICS—RHEOSTAT MODE</b>						
Resolution	N		5			Bits
Resistor Integral Nonlinearity <sup>2</sup>	R-INL		-0.5		+0.5	LSB
Resistor Differential Nonlinearity <sup>2</sup>	R-DNL		-0.25		+0.25	LSB
Nominal Resistor Tolerance	$\Delta R_{AB}/R_{AB}$		-8		+8	%
Resistance Temperature Coefficient <sup>3</sup>	$(\Delta R_{AB}/R_{AB})/\Delta T \times 10^6$			35		ppm/ $^\circ\text{C}$
Wiper Resistance	$R_W$	Code = zero scale		70	140	$\Omega$
	$R_{BS}$	Code = bottom scale		45	80	$\Omega$
	$R_{TS}$	Code = top scale		70	140	$\Omega$
<b>DC CHARACTERISTICS—POTENTIOMETER DIVIDER MODE</b>						
Integral Nonlinearity <sup>4</sup>	INL		-0.25		+0.25	LSB
Differential Nonlinearity <sup>4</sup>	DNL		-0.25		+0.25	LSB
Full-Scale Error	$V_{WFSE}$	$R_{AB} = 10 \text{ k}\Omega$	-1			LSB
		$R_{AB} = 80 \text{ k}\Omega$	-0.5			LSB
Zero-Scale Error	$V_{WZSE}$	$R_{AB} = 10 \text{ k}\Omega$			1	LSB
		$R_{AB} = 80 \text{ k}\Omega$			0.25	LSB
Voltage Divider Temperature Coefficient <sup>3</sup>	$(\Delta V_W/V_W)/\Delta T \times 10^6$	Code = half scale		$\pm 10$		ppm/ $^\circ\text{C}$
<b>RESISTOR TERMINALS</b>						
Maximum Continuous $I_A$ , $I_B$ , and $I_W$ Current <sup>3</sup>		$R_{AB} = 10 \text{ k}\Omega$	-6		+6	mA
		$R_{AB} = 80 \text{ k}\Omega$	-1.5		+1.5	mA
Terminal Voltage Range <sup>5</sup>			GND		$V_{DD}$	V
Capacitance A, Capacitance B <sup>3,6</sup>	$C_A, C_B$	f = 1 MHz, measured to GND, code = half scale		20		pF
Capacitance W <sup>3,6</sup>	$C_W$	f = 1 MHz, measured to GND, code = half scale		35		pF
Common-Mode Leakage Current <sup>3</sup>		$V_A = V_W = V_B$	-500	$\pm 15$	+500	nA
<b>DIGITAL INPUTS</b>						
Input Logic <sup>3</sup>						
High	$V_{INH}$		2			V
Low	$V_{INL}$				0.8	V
Input Current <sup>3</sup>	$I_N$				$\pm 1$	$\mu\text{A}$
Input Capacitance <sup>3</sup>	$C_{IN}$			5		pF
<b>POWER SUPPLIES</b>						
Single-Supply Power Range			2.3		5.5	V
Positive Supply Current	$I_{DD}$	$V_{IH} = V_{DD}$ or $V_{IL} = \text{GND}$ , $V_{DD} = 5 \text{ V}$		0.75	3.5	$\mu\text{A}$
		$V_{IH} = V_{DD}$ or $V_{IL} = \text{GND}$ , $V_{DD} = 2.7 \text{ V}$			2.5	$\mu\text{A}$
		$V_{IH} = V_{DD}$ or $V_{IL} = \text{GND}$ , $V_{DD} = 2.3 \text{ V}$			2.4	$\mu\text{A}$
EEMEM Store Current <sup>3,7</sup>	$I_{DD\_NVM\_STORE}$			2		mA
EEMEM Read Current <sup>3,8</sup>	$I_{DD\_NVM\_READ}$			320		$\mu\text{A}$
Power Dissipation <sup>9</sup>	$P_{DISS}$	$V_{IH} = V_{DD}$ or $V_{IL} = \text{GND}$		5		$\mu\text{W}$
Power Supply Rejection <sup>3</sup>	PSR	$\Delta V_{DD}/\Delta V_{SS} = 5 \text{ V} \pm 10\%$				
		$R_{AB} = 10 \text{ k}\Omega$			-50	dB
		$R_{AB} = 80 \text{ k}\Omega$			-64	dB

Parameter	Symbol	Test Conditions/Comments	Min	Typ <sup>1</sup>	Max	Unit
DYNAMIC CHARACTERISTICS <sup>3,10</sup>						
Bandwidth	BW	Code = half scale, -3 dB R <sub>AB</sub> = 10 kΩ R <sub>AB</sub> = 80 kΩ		2 200		MHz kHz
Total Harmonic Distortion	THD	V <sub>A</sub> = V <sub>DD</sub> /2 + 1 V rms, V <sub>B</sub> = V <sub>DD</sub> /2, f = 1 kHz, code = half scale R <sub>AB</sub> = 10 kΩ R <sub>AB</sub> = 80 kΩ		-80 -85		dB dB
V <sub>W</sub> Settling Time	t <sub>s</sub>	V <sub>A</sub> = 5 V, V <sub>B</sub> = 0 V, ±0.5 LSB error band R <sub>AB</sub> = 10 kΩ R <sub>AB</sub> = 80 kΩ		2.7 9.5		μs μs
Resistor Noise Density	e <sub>N_WB</sub>	Code = half scale, T <sub>A</sub> = 25°C, f = 100 kHz R <sub>AB</sub> = 10 kΩ R <sub>AB</sub> = 80 kΩ		9 20		nV/√Hz V
FLASH/EE MEMORY RELIABILITY <sup>3</sup>						
Endurance <sup>11</sup>		T <sub>A</sub> = 25°C		1		MCycles
Data Retention <sup>12</sup>			100	50		kCycles Years

<sup>1</sup> Typical values represent average readings at 25°C, V<sub>DD</sub> = 5 V, V<sub>SS</sub> = 0 V, and V<sub>LOGIC</sub> = 5 V.

<sup>2</sup> R-INL is the deviation from an ideal value measured between the maximum resistance and the minimum resistance wiper positions. R-DNL measures the relative step change from ideal between successive tap positions. The maximum wiper current is limited to  $0.8 \times V_{DD}/R_{AB}$ .

<sup>3</sup> Guaranteed by design and characterization; not subject to production test.

<sup>4</sup> INL and DNL are measured at V<sub>WB</sub> with the RDAC configured as a potentiometer divider similar to a voltage output DAC. V<sub>A</sub> = V<sub>DD</sub> and V<sub>B</sub> = 0 V. DNL specification limits of ±1 LSB maximum are guaranteed monotonic operating conditions.

<sup>5</sup> Resistor Terminal A, Resistor Terminal B, and Resistor Terminal W have no limitations on current direction with respect to each other.

<sup>6</sup> C<sub>A</sub> is measured with V<sub>W</sub> = V<sub>A</sub> = 2.5 V, C<sub>B</sub> is measured with V<sub>W</sub> = V<sub>B</sub> = 2.5 V, and C<sub>W</sub> is measured with V<sub>A</sub> = V<sub>B</sub> = 2.5 V.

<sup>7</sup> Different from operating current; supply current for NVM program lasts approximately 30 ms.

<sup>8</sup> Different from operating current; supply current for NVM read lasts approximately 20 μs.

<sup>9</sup> P<sub>DISS</sub> is calculated from (I<sub>DD</sub> × V<sub>DD</sub>).

<sup>10</sup> All dynamic characteristics use V<sub>DD</sub> = 5.5 V and V<sub>LOGIC</sub> = 5 V.

<sup>11</sup> Endurance is qualified at 100,000 cycles per JEDEC Standard 22, Method A117 and measured at 150°C.

<sup>12</sup> Retention lifetime equivalent at junction temperature (T<sub>J</sub>) is 125°C per JEDEC Standard 22, Method A117. Retention lifetime based on an activation energy of 1 eV derates with junction temperature in the Flash/EE memory.



**INTERFACE TIMING SPECIFICATIONS**

$V_{DD} = 2.3\text{ V to }5.5\text{ V}$ ; all specifications  $T_{MIN}$  to  $T_{MAX}$ , unless otherwise noted.

Table 5.

Parameter	Test Conditions/Comments	Min	Typ	Max	Unit	Description
$f_{CLK}$	$V_{DD} \geq 2.7\text{ V}$			50	MHz	Clock frequency
	$V_{DD} < 2.7\text{ V}$			25	MHz	
$t_1$		25			ns	$\overline{CS}$ setup time
$t_2$	$V_{DD} \geq 2.7\text{ V}$	10			ns	$\overline{CLK}$ low time
	$V_{DD} < 2.7\text{ V}$	20			ns	
$t_3$	$V_{DD} \geq 2.7\text{ V}$	10			ns	$\overline{CLK}$ high time
	$V_{DD} < 2.7\text{ V}$	20			ns	
$t_4$		15			ns	$U/\overline{D}$ setup time
$t_5$		6			ns	$U/\overline{D}$ hold time
$t_6$	$V_{DD} \geq 2.7\text{ V}$	20			ns	$\overline{CS}$ rise to $\overline{CLK}$ hold time
	$V_{DD} < 2.7\text{ V}$	40			ns	
$t_7$		15			ns	$\overline{CS}$ rising edge to next $\overline{CLK}$ ignored
$t_8$	$V_{DD} \geq 2.7\text{ V}$	12			ns	$U/\overline{D}$ minimum pulse time
	$V_{DD} < 2.7\text{ V}$	24			ns	
$t_9$		12			ns	$U/\overline{D}$ rise to $\overline{CLK}$ falling edge
$t_{10}$		1			$\mu\text{s}$	Minimum $\overline{CS}$ time
$t_{EEPROM\_PROGRAM}^1$			15	50	ms	Memory program time
$t_{POWER\_UP}^2$				50	$\mu\text{s}$	Power-on EEPROM restore time

<sup>1</sup> EEPROM program time depends on the temperature and EEPROM write cycles. Higher timing is expected at a lower temperature and higher write cycles.

<sup>2</sup> Maximum time after  $V_{DD}$  is equal to 2.3 V.

**TIMING DIAGRAMS**

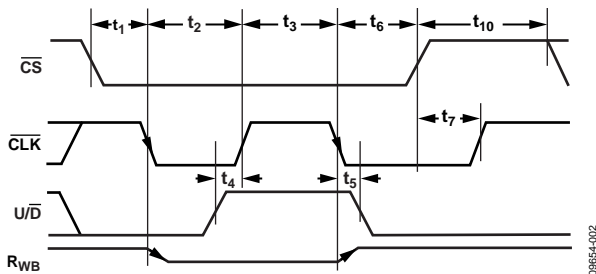

Figure 2. Increment/Decrement Mode Timing

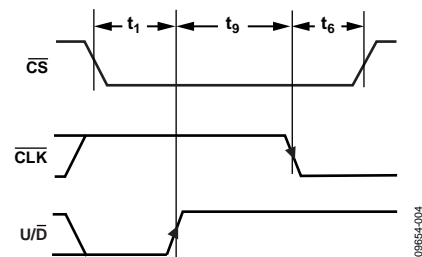

Figure 4. Shutdown Mode Timing

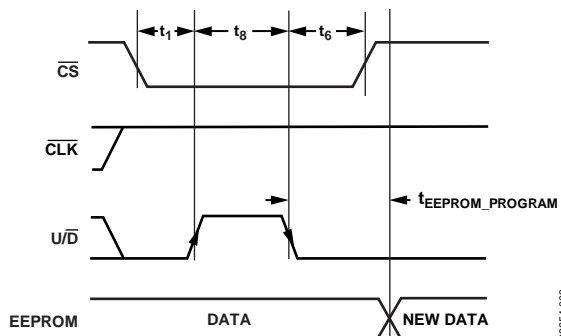

Figure 3. Storage Mode Timing

09854-002

09854-004

09854-003

## ABSOLUTE MAXIMUM RATINGS

$T_A = 25^\circ\text{C}$ , unless otherwise noted.

Table 6.

Parameter	Rating
$V_{DD}$ to GND	-0.3 V to +7.0 V
$V_{LOGIC}$ to GND	-0.3 V to +7.0 V
$V_A, V_W, V_B$ to GND	GND - 0.3 V to $V_{DD} + 0.3$ V
$I_A, I_W, I_B$	
Pulsed <sup>1</sup>	
Frequency > 10 kHz	
$R_{AW} = 5$ k $\Omega$ and 10 k $\Omega$	$\pm 6$ mA/d <sup>2</sup>
$R_{AW} = 80$ k $\Omega$	$\pm 1.5$ mA/d <sup>2</sup>
Frequency $\leq$ 10 kHz	
$R_{AW} = 5$ k $\Omega$ and 10 k $\Omega$	$\pm 6$ mA/ $\sqrt{d^2}$
$R_{AW} = 80$ k $\Omega$	$\pm 1.5$ mA/ $\sqrt{d^2}$
Continuous	
$R_{AW} = 5$ k $\Omega$ and 10 k $\Omega$	$\pm 6$ mA
$R_{AW} = 80$ k $\Omega$	$\pm 1.5$ mA
Digital Inputs $\overline{U/D}$ , $\overline{CLK}$ , and $\overline{CS}$	-0.3 V to +7 V or $V_{DD} + 0.3$ V (whichever is less)
Operating Temperature Range <sup>3</sup>	-40°C to +125°C
Maximum Junction Temperature ( $T_J$ Max)	150°C
Storage Temperature Range	-65°C to +150°C
Reflow Soldering	
Peak Temperature	260°C
Time at Peak Temperature	20 sec to 40 sec
Package Power Dissipation	$(T_J \text{ max} - T_A)/\theta_{JA}$

<sup>1</sup> Maximum terminal current is bounded by the maximum current handling of the switches, maximum power dissipation of the package, and maximum applied voltage across any two of the A, B, and W terminals at a given resistance.

<sup>2</sup> Pulse duty factor.

<sup>3</sup> Includes programming of EEPROM memory.

Stresses above those listed under Absolute Maximum Ratings may cause permanent damage to the device. This is a stress rating only; functional operation of the device at these or any other conditions above those indicated in the operational section of this specification is not implied. Exposure to absolute maximum rating conditions for extended periods may affect device reliability.

### THERMAL RESISTANCE

$\theta_{JA}$  is defined by JEDEC specification JESD-51, and the value is dependent on the test board and test environment.

Table 7. Thermal Resistance

Package Type	$\theta_{JA}$	$\theta_{JC}$	Unit
8-Lead LFCSP	90 <sup>1</sup>	25	°C/W

<sup>1</sup> JEDEC 2S2P test board, still air (0 m/sec air flow).

### ESD CAUTION



#### ESD (electrostatic discharge) sensitive device.

Charged devices and circuit boards can discharge without detection. Although this product features patented or proprietary protection circuitry, damage may occur on devices subjected to high energy ESD. Therefore, proper ESD precautions should be taken to avoid performance degradation or loss of functionality.

## PIN CONFIGURATION AND FUNCTION DESCRIPTIONS

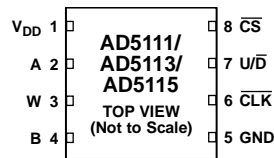

## NOTES

1. THE EXPOSED PAD IS INTERNALLY FLOATING.

09854-008

Figure 5. Pin Configuration

Table 8. Pin Function Descriptions

Pin No.	Mnemonic	Description
1	$V_{DD}$	Positive Power Supply. Decouple this pin with 0.1 $\mu$ F ceramic capacitors and 10 $\mu$ F capacitors.
2	A	Terminal A of RDAC. $GND \leq V_A \leq V_{DD}$ .
3	W	Wiper Terminal of RDAC. $GND \leq V_W \leq V_{DD}$ .
4	B	Terminal B of RDAC. $GND \leq V_B \leq V_{DD}$ .
5	GND	Ground Pin, Logic Ground Reference.
6	CLK	Clock Input. Each clock pulse executes the step-up or step-down of the resistance. The direction is determined by the state of the U/D pin. CLK is a negative edge trigger. Data can be transferred at rates up to 50 MHz.
7	U/D	Up/Down Selection Counter Control.
8	CS	Chip Select. Active Low.
	EPAD	Exposed Pad. The exposed pad is internally floating.

TYPICAL PERFORMANCE CHARACTERISTICS

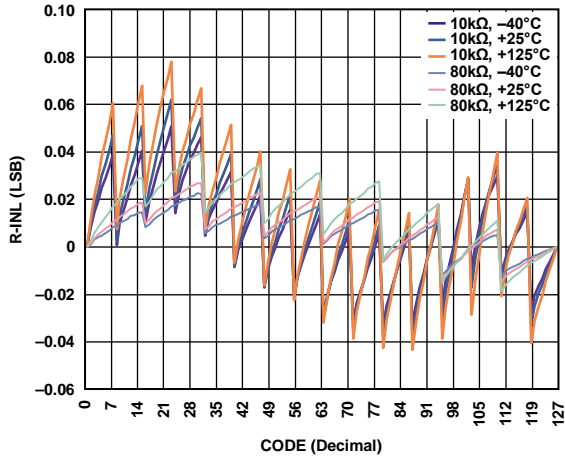

Figure 6. R-INL vs. Code (AD5111)

09654-007

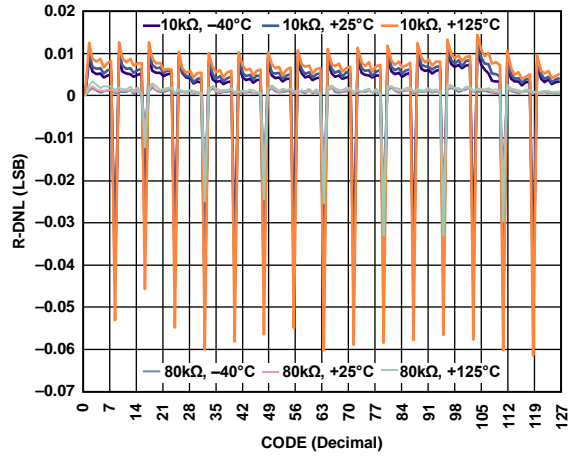

Figure 9. R-DNL vs. Code (AD5111)

09654-010

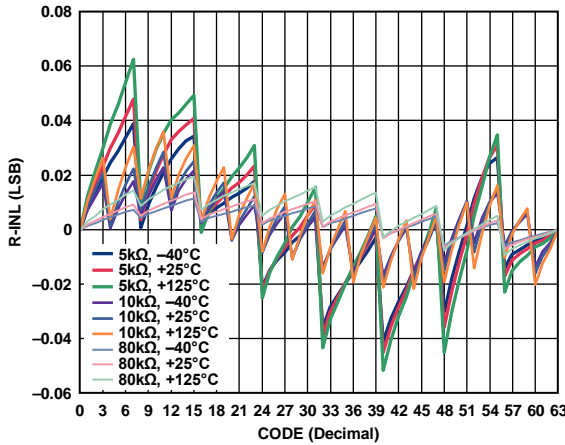

Figure 7. R-INL vs. Code (AD5113)

09654-008

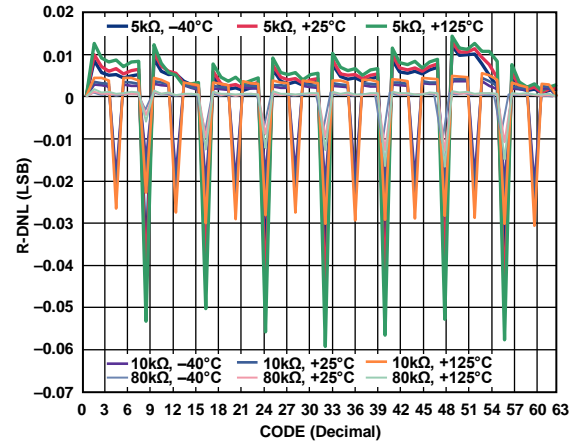

Figure 10. R-DNL vs. Code (AD5113)

09654-011

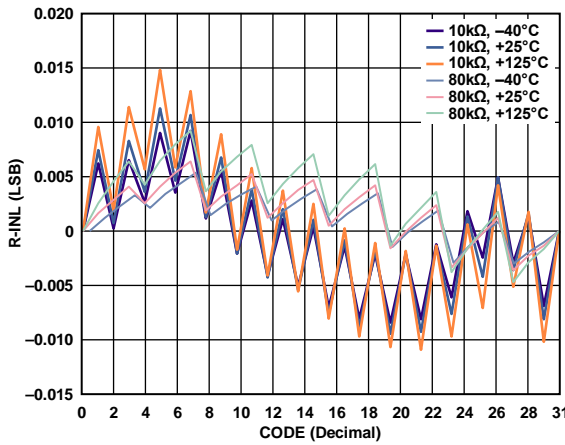

Figure 8. R-INL vs. Code (AD5115)

09654-009

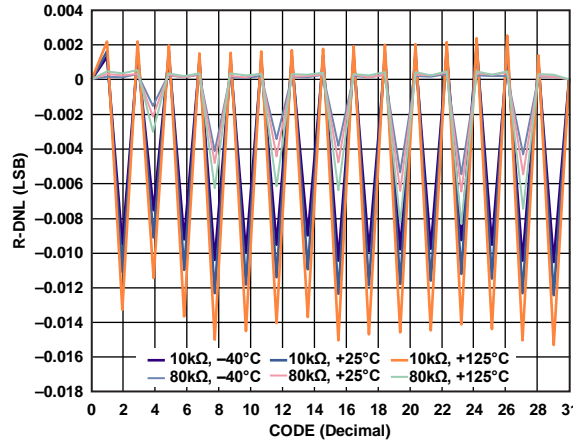

Figure 11. R-DNL vs. Code (AD5115)

09654-012

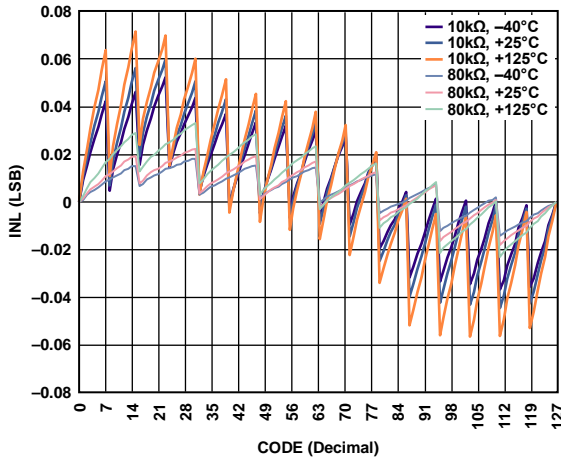

Figure 12. INL vs. Code (AD5111)

09854-013

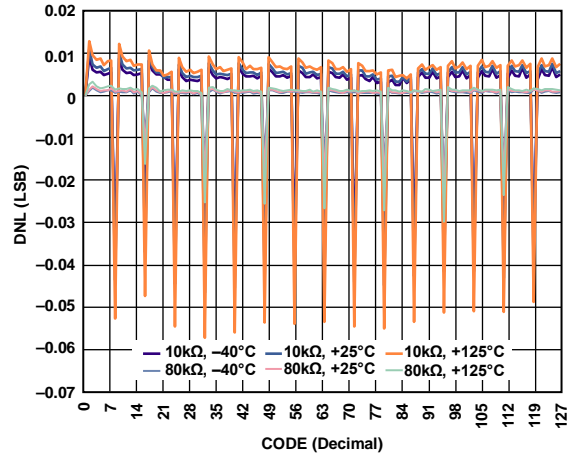

Figure 15. DNL vs. Code (AD5111)

09854-016

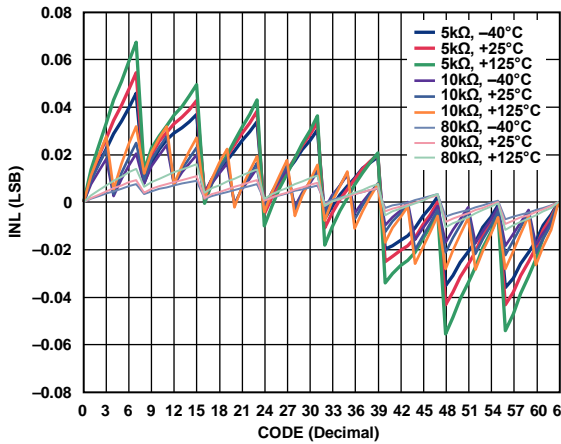

Figure 13. INL vs. Code (AD5113)

09854-014

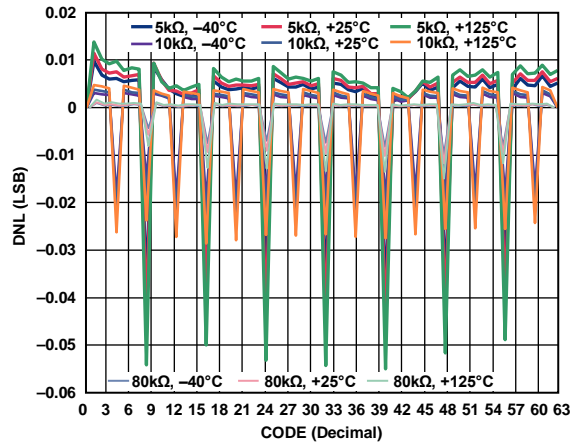

Figure 16. DNL vs. Code (AD5113)

09854-017

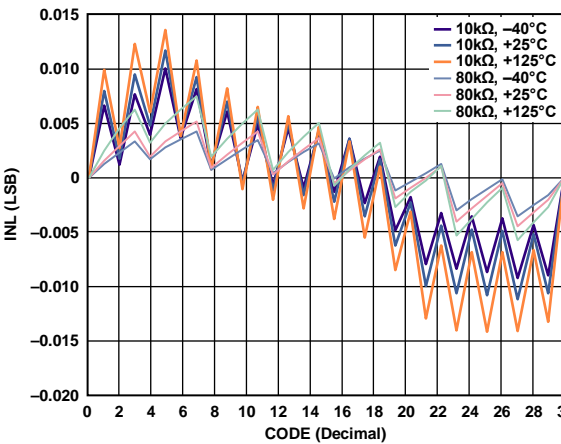

Figure 14. INL vs. Code (AD5115)

09854-015

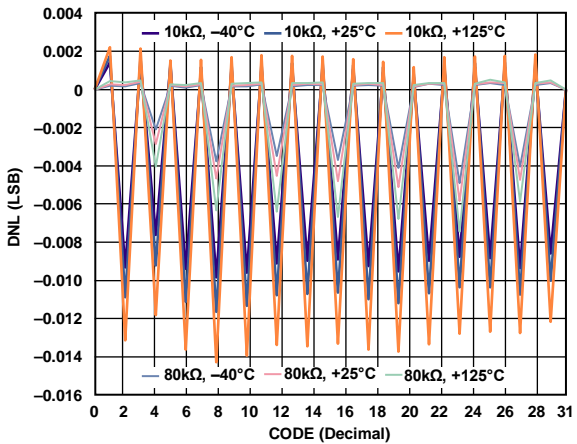

Figure 17. DNL vs. Code (AD5115)

09854-018

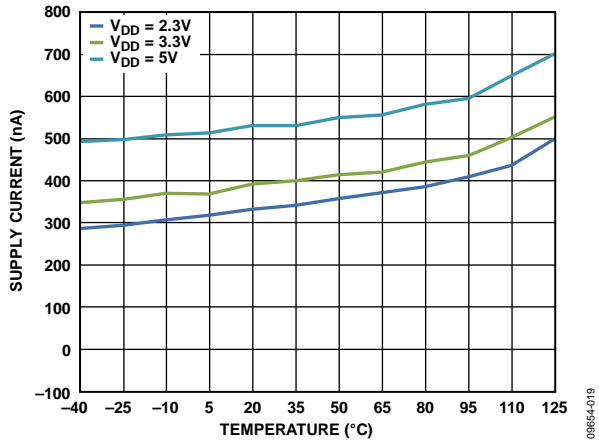

Figure 18. Supply Current vs. Temperature

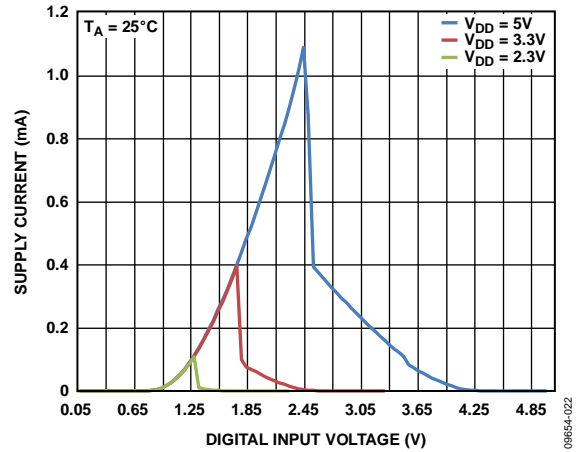

Figure 21. Supply Current ( $I_{DD}$ ) vs. Digital Input Voltage

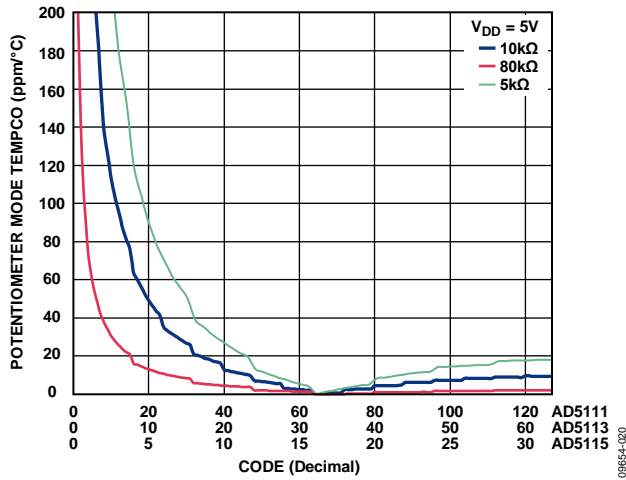

Figure 19. Potentiometer Mode Tempco ( $(\Delta V_w/V_w)/\Delta T \times 10^6$ ) vs. Code

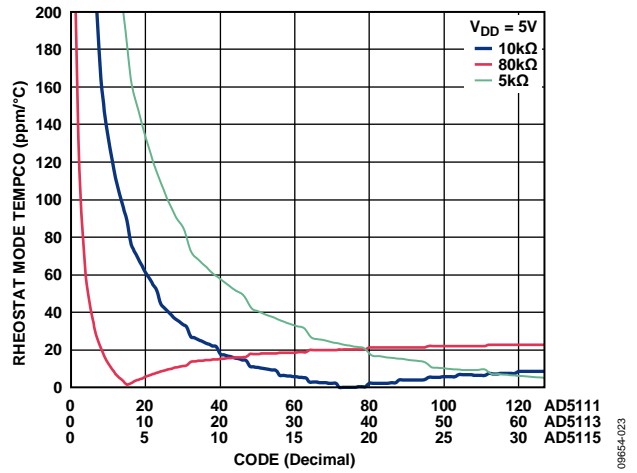

Figure 22. Rheostat Mode Tempco ( $(\Delta R_{WB}/R_{WB})/\Delta T \times 10^6$ ) vs. Code

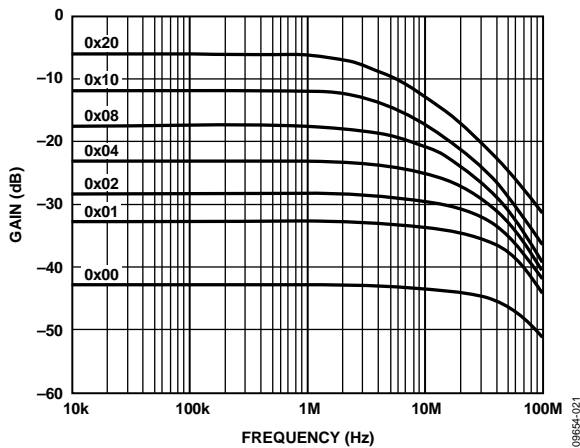

Figure 20. 5 kΩ Gain vs. Frequency vs. Code

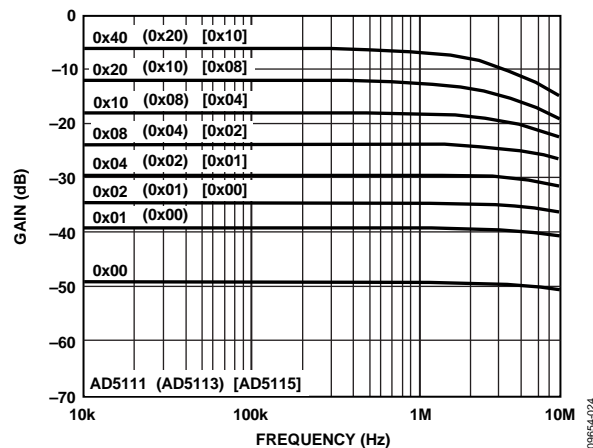

Figure 23. 10 kΩ Gain vs. Frequency vs. Code

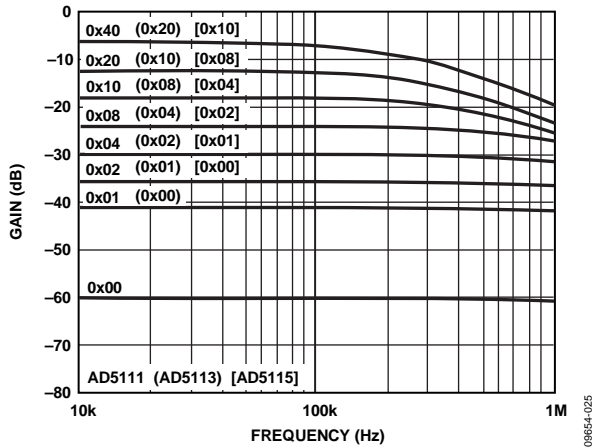

Figure 24. 80 kΩ Gain vs. Frequency vs. Code

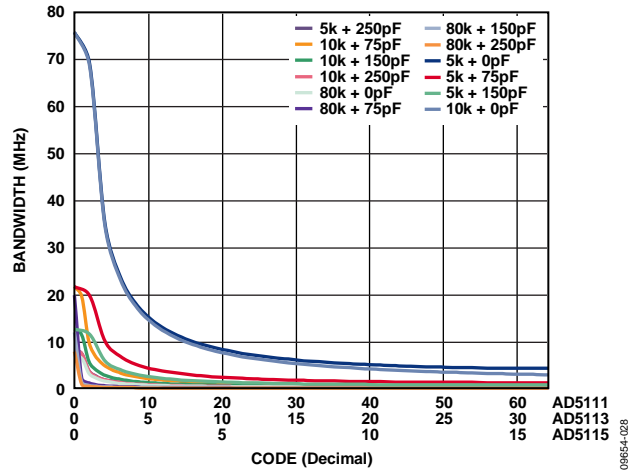

Figure 27. Maximum Bandwidth vs. Code vs. Net Capacitance

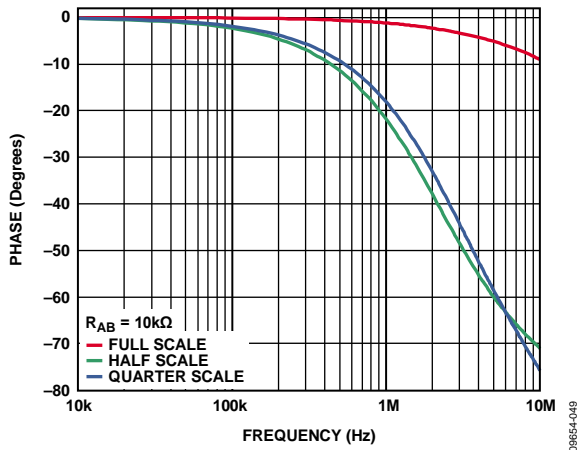

Figure 25. Normalized Phase Flatness vs. Frequency

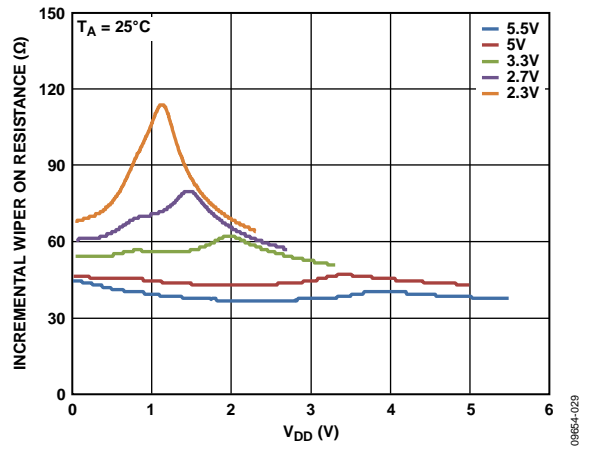

Figure 28. Incremental Wiper On Resistance vs.  $V_{DD}$

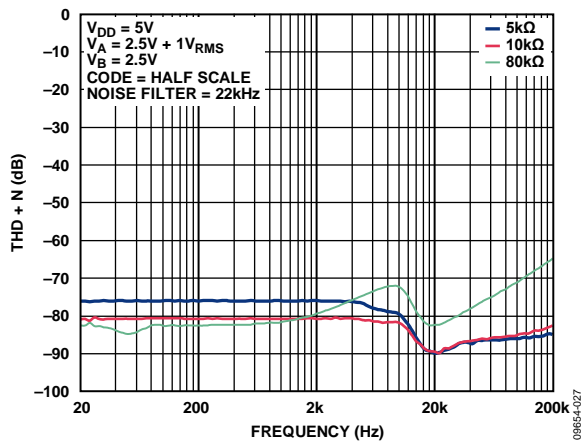

Figure 26. Total Harmonic Distortion + Noise (THD + N) vs. Frequency

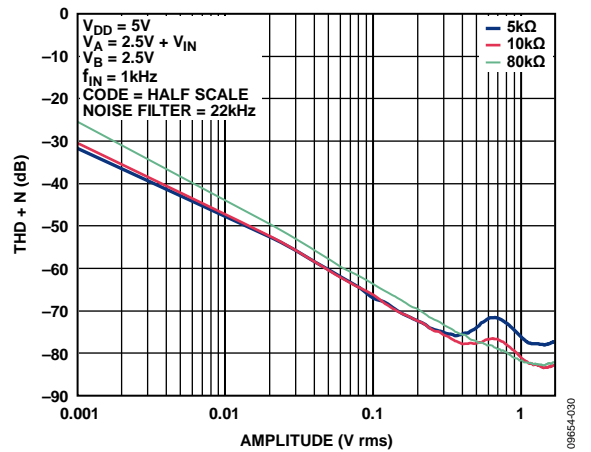

Figure 29. Total Harmonic Distortion + Noise (THD + N) vs. Amplitude

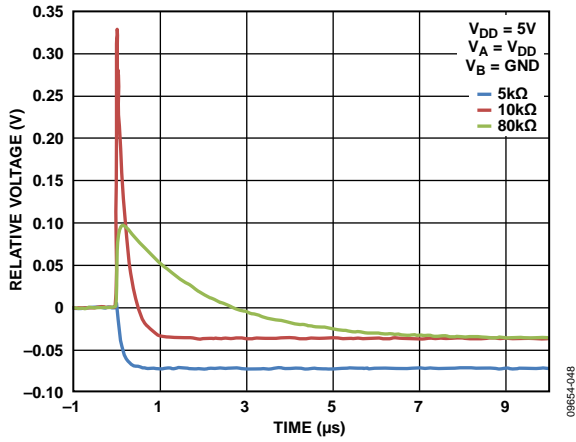

Figure 30. Maximum Transition Glitch

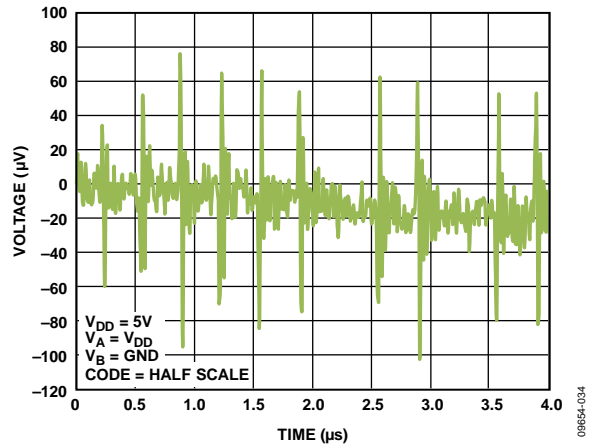

Figure 33. Digital Feedthrough

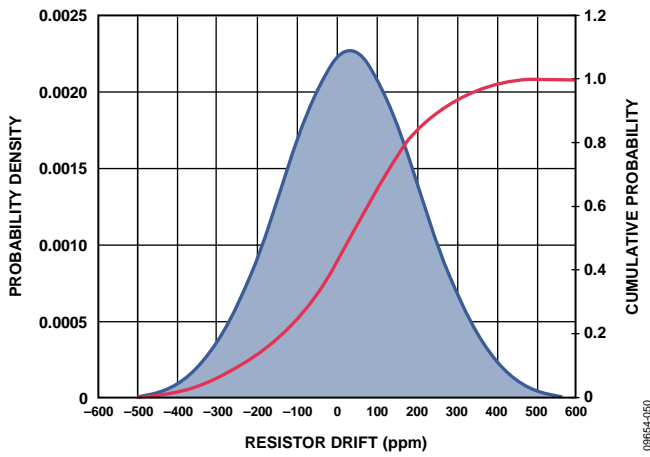

Figure 31. Resistor Lifetime Drift

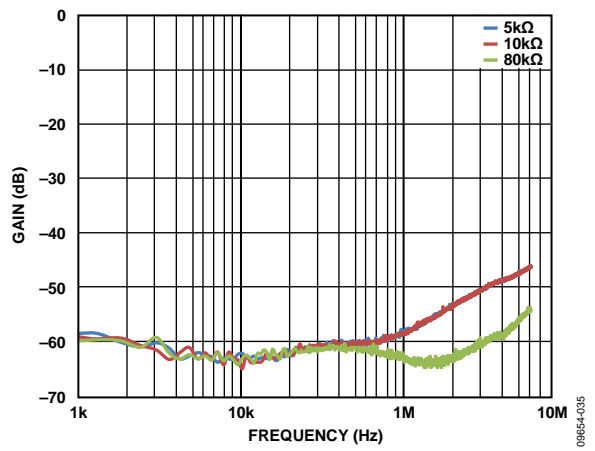

Figure 34. Shutdown Isolation vs. Frequency

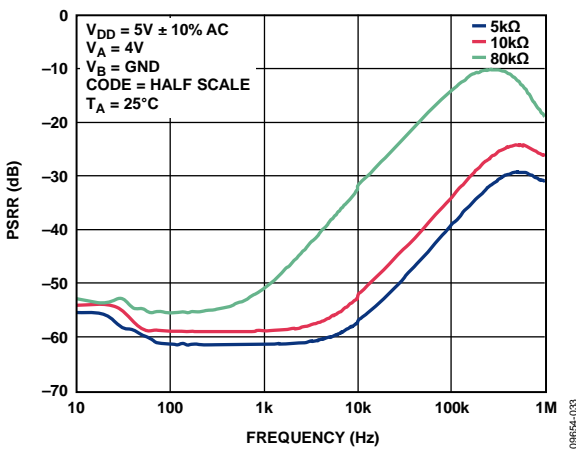

Figure 32. Power Supply Rejection Ratio (PSRR) vs. Frequency

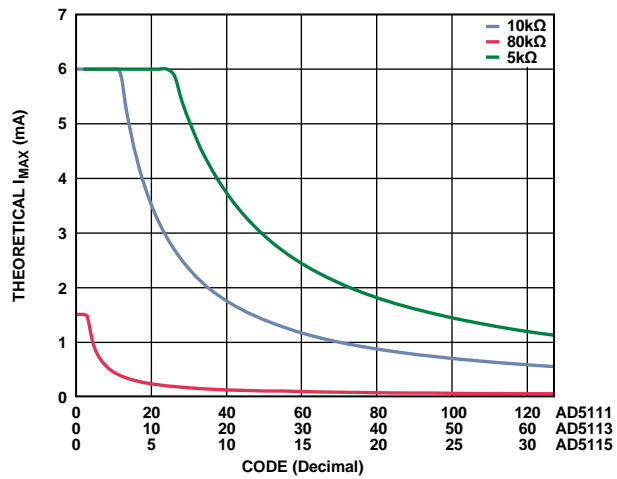

Figure 35. Theoretical Maximum Current vs. Code



### TEST CIRCUITS

Figure 36 to Figure 41 define the test conditions used in the Specifications section.

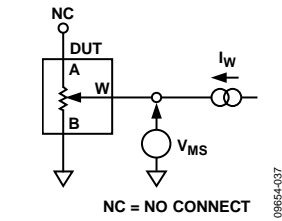

Figure 36. Resistor Position Nonlinearity Error (Rheostat Operation: R-INL, R-DNL)

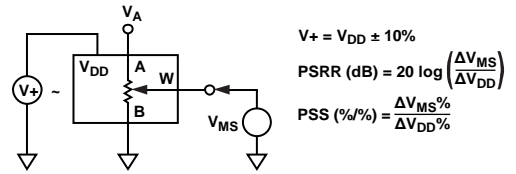

Figure 39. Power Supply Sensitivity (PSS, PSRR)

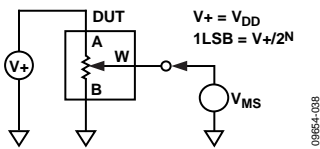

Figure 37. Potentiometer Divider Nonlinearity Error (INL, DNL)

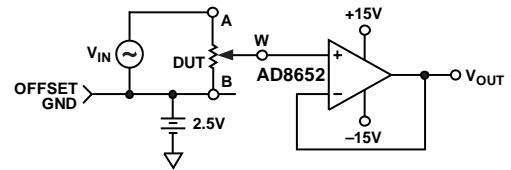

Figure 40. Gain and Phase vs. Frequency

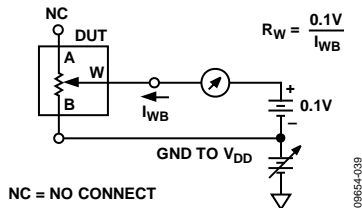

Figure 38. Wiper Resistance

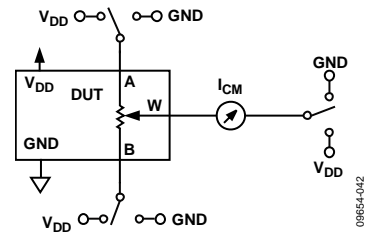

Figure 41. Common-Mode Leakage Current

## THEORY OF OPERATION

The AD5111/AD5113/AD5115 digital programmable resistors are designed to operate as true variable resistors for analog signals within the terminal voltage range of  $GND < V_{TERM} < V_{DD}$ . The resistor wiper position is determined by the RDAC register contents. The RDAC register acts as a scratchpad register that allows unlimited changes of resistance settings.

The RDAC register can be programmed with any position setting using the up/down interface. Once a desirable wiper position is found, this value can be stored in the EEPROM. Thereafter, the wiper position is always restored to that position for subsequent power-up. The storing of EEPROM data takes approximately 30 ms; during this time, the device is locked and does not accept any new operation, thus preventing any changes from taking place.

The AD5111/AD5113/AD5115 are designed to allow high speed digital control with clock rates up to 50 MHz.

### RDAC REGISTER AND EEPROM

The RDAC register directly controls the position of the digital potentiometer wiper. For example, when the RDAC register is 0x40 (AD5111), the wiper is connected to midscale of the variable resistor. The RDAC register is a standard logic register; there is no restriction on the number of changes allowed.

Once a desirable wiper position is found, this value can be saved into the EEPROM. Thereafter, the wiper position is always set at that position for any future on-off-on power supply sequence or recall operation.

### BASIC OPERATION

When  $\overline{CS}$  is pulled low, changing the resistance settings is achieved by clocking the  $\overline{CLK}$  pin. It is negative edge triggered, and the direction of stepping into the RDAC register is determined by the state of the  $U/\overline{D}$  input. When a specific state of the  $U/\overline{D}$  remains, the device continues to change in the same direction under consecutive clocks until it comes to the end of the resistance setting. When the wiper reaches the maximum or minimum setting, additional  $\overline{CLK}$  pulses do not change the wiper setting. Figure 2 shows a typical increment/decrement operation.

The  $U/\overline{D}$  pin value can be changed only when the  $\overline{CLK}$  pin is low.

### LOW WIPER RESISTANCE FEATURE

The AD5111/AD5113/AD5115 include a new feature to reduce the resistance between terminals. These extra steps are called bottom scale and top scale. At bottom scale, the typical wiper resistance decreases from 70  $\Omega$  to 45  $\Omega$ . At top scale, the resistance between Terminal A and Terminal W is decreased by 1 LSB and the total resistance is reduced to 70  $\Omega$ . The new extra steps are loaded automatically in the RDAC register after zero-scale or full-scale position has been reached.

The extra steps are not equal to 1 LSB and are not included in the INL, DNL, R-INL, and R-DNL specifications.

### SHUTDOWN MODE

This feature places Terminal A in open circuit, disconnected from the internal resistor, and connects Terminal W and Terminal B. A finite wiper resistance of 45  $\Omega$  is present between these two terminals. The command is sent by a low-to-high transition on the  $U/\overline{D}$  pin, when  $\overline{CLK}$  is high and  $\overline{CS}$  is enabled. The command is executed on the  $\overline{CLK}$  negative edge, as shown in Figure 4.

The AD5111/AD5113/AD5115 return the wiper to prior shutdown position if any other operation is performed.

### EEPROM WRITE OPERATION

The AD5111/AD5113/AD5115 contain an EEPROM that allows the wiper position storage. Once a desirable wiper position is found, this value can be saved into the EEPROM. Thereafter, the wiper position is always set at that position for any future power-up sequence or a memory recall operation.

During the storage cycle, the device is locked and does not accept any new operation, thus preventing any changes from taking place.

The write cycle is started by applying a pulse in the  $U/\overline{D}$  pin when  $\overline{CS}$  is enabled and  $\overline{CLK}$  remains high, as shown in Figure 3. The write cycle takes approximately 20 ms.

**RDAC ARCHITECTURE**

To achieve optimum performance, Analog Devices, Inc., has patented the RDAC segmentation architecture for all the digital potentiometers. In particular, the AD5111/AD5113/AD5115 employ a two-stage segmentation approach as shown in Figure 42. The AD5111/AD5113/AD5115 wiper switch is designed with the transmission gate CMOS topology and with the gate voltage derived from  $V_{DD}$ .

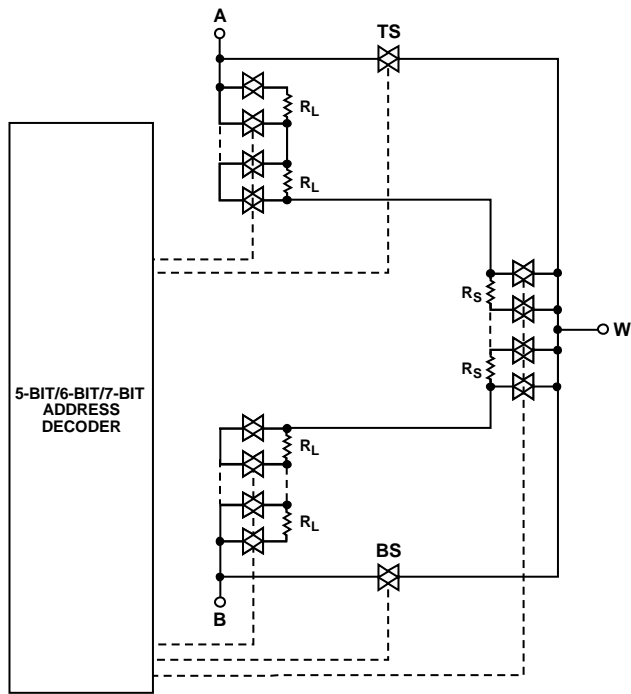

Figure 42. AD5111/AD5113/AD5115 Simplified RDAC Circuit

**Low Wiper Resistance Feature**

In addition, the AD5111/AD5113/AD5115 include a new feature to reduce the resistance between terminals. These extra steps are called bottom scale and top scale. At bottom scale, the typical wiper resistance decreases from 70  $\Omega$  to 45  $\Omega$ . At top scale, the resistance between Terminal A and Terminal W is decreased by 1 LSB and the total resistance is reduced to 70  $\Omega$ . The extra steps are not equal to 1 LSB and are not included in the INL, DNL, R-INL, and R-DNL specifications.

**PROGRAMMING THE VARIABLE RESISTOR**

**Rheostat Operation— $\pm 8\%$  Resistor Tolerance**

The AD5111/AD5113/AD5115 operate in rheostat mode when only two terminals are used as a variable resistor. The unused terminal can be floating or tied to the W terminal as shown in Figure 43.

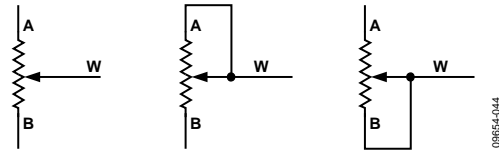

Figure 43. Rheostat Mode Configuration

The nominal resistance between Terminal A and Terminal B,  $R_{AB}$ , is available in 5 k $\Omega$ , 10 k $\Omega$ , and 80 k $\Omega$  and has 128/64/32 tap points accessed by the wiper terminal. The 5-/6-/7-bit data in the RDAC latch is decoded to select one of the 128/64/32 possible wiper settings. The general equations for determining the digitally programmed output resistance between the W terminal and B terminal are

AD5111:

$$R_{WB} = R_{BS} \quad \text{Bottom scale (1)}$$

$$R_{WB}(D) = \frac{D}{128} \times R_{AB} + R_W \quad \text{From 0 to 128 (2)}$$

AD5113:

$$R_{WB} = R_{BS} \quad \text{Bottom scale (3)}$$

$$R_{WB}(D) = \frac{D}{64} \times R_{AB} + R_W \quad \text{From 0 to 64 (4)}$$

AD5115:

$$R_{WB} = R_{BS} \quad \text{Bottom scale (5)}$$

$$R_{WB}(D) = \frac{D}{32} \times R_{AB} + R_W \quad \text{From 0 to 32 (6)}$$

where:

$D$  is the decimal equivalent of the binary code in the 5-/6-/7-bit RDAC register; 128, 64, and 32 refer to the top scale step.

$R_{AB}$  is the end-to-end resistance.

$R_W$  is the wiper resistance.

$R_{BS}$  is the wiper resistance at bottom scale.

Similar to the mechanical potentiometer, the resistance of the RDAC between the W terminal and the A terminal also produces a digitally controlled complementary resistance,  $R_{WA}$ .  $R_{WA}$  starts at the maximum resistance value and decreases as the data loaded into the latch increases. The general equations for this operation are

**AD5111:**

$$R_{AW} = R_{AB} + R_W \quad \text{Bottom scale (7)}$$

$$R_{AW}(D) = \frac{128-D}{128} \times R_{AB} + R_W \quad \text{From 0 to 127 (8)}$$

$$R_{AW} = R_{TS} \quad \text{Top scale (9)}$$

**AD5113:**

$$R_{AW} = R_{AB} + R_W \quad \text{Bottom scale (10)}$$

$$R_{AW}(D) = \frac{64-D}{64} \times R_{AB} + R_W \quad \text{From 0 to 63 (11)}$$

$$R_{AW} = R_{TS} \quad \text{Top scale (12)}$$

**AD5115:**

$$R_{AW} = R_{AB} + R_W \quad \text{Bottom scale (13)}$$

$$R_{AW}(D) = \frac{32-D}{32} \times R_{AB} + R_W \quad \text{From 0 to 31 (14)}$$

$$R_{AW} = R_{TS} \quad \text{Top scale (15)}$$

where:

$D$  is the decimal equivalent of the binary code in the 5-/6-/7-bit RDAC register; 128, 64, and 32 refer to top scale step.

$R_{AB}$  is the end-to-end resistance.

$R_W$  is the wiper resistance.

$R_{TS}$  is the wiper resistance at top scale.

Regardless of which setting the part is operating in, take care to limit the current between A to B, W to A, and W to B, to the maximum continuous current of  $\pm 6$  mA (5 k $\Omega$  and 10 k $\Omega$ ) or  $\pm 1.5$  mA (80 k $\Omega$ ), or pulse current specified in Table 6. Otherwise, degradation or possible destruction of the internal switch contact can occur.

**PROGRAMMING THE POTENTIOMETER DIVIDER****Voltage Output Operation**

The digital potentiometer easily generates a voltage divider at W-to-B and W-to-A that is proportional to the input voltage at A-to-B, as shown in Figure 44. Unlike the polarity of  $V_{DD}$  to GND, which must be positive, current across A-to-B, W-to-A, and W-to-B can be in either direction.

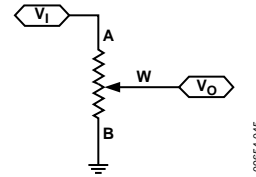

Figure 44. Potentiometer Mode Configuration

If ignoring the effect of the wiper resistance for simplicity, connecting Terminal A to 5 V and Terminal B to ground produces an output voltage at W to B ranging from 0 V to 5 V. The general equation defining the output voltage at  $V_W$  with respect to ground for any valid input voltage applied to Terminal A and Terminal B, is

$$V_W(D) = \frac{R_{WB}(D)}{R_{AB}} \times V_A + \frac{R_{AW}(D)}{R_{AB}} \times V_B \quad (16)$$

where:

$R_{WB}(D)$  can be obtained from Equation 1 to Equation 6.

$R_{AW}(D)$  can be obtained from Equation 7 to Equation 14.

Operation of the digital potentiometer in the divider mode results in a more accurate operation over temperature. Unlike the rheostat mode, the output voltage is dependent mainly on the ratio of the internal resistors,  $R_{WA}$  and  $R_{WB}$ , and not the absolute values. Therefore, the temperature drift reduces to 5 ppm/ $^{\circ}$ C.

**TERMINAL VOLTAGE OPERATING RANGE**

The AD5111/AD5113/AD5115 are designed with internal ESD diodes for protection. These diodes also set the voltage boundary of the terminal operating voltages. Positive signals present on the A, B, or W terminals that exceed  $V_{DD}$  are clamped by the forward-biased diode. There is no polarity constraint between  $V_A$ ,  $V_W$ , and  $V_B$ , but they cannot be higher than  $V_{DD}$  or lower than GND.

**POWER-UP SEQUENCE**

Because of the ESD protection diodes that limit the voltage compliance at the A, B, and W terminals (see Figure 45), it is important to power on  $V_{DD}$  before applying any voltage to the A, B, and W terminals. Otherwise, the diodes are forward-biased such that  $V_{DD}$  is powered on unintentionally and can affect other parts of the circuit. Similarly,  $V_{DD}$  should be powered down last. The ideal power-on sequence is in the following order: GND,  $V_{DD}$ , and  $V_A/V_B/V_W$ . The order of powering  $V_A$ ,  $V_B$ ,  $V_W$  and the digital inputs is not important as long as they are powered on after  $V_{DD}$ .

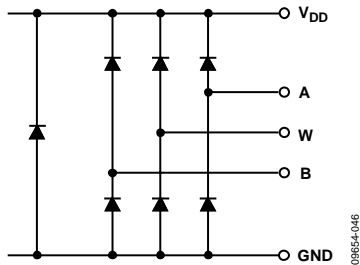

Figure 45. Maximum Terminal Voltages Set by  $V_{DD}$  and GND

**LAYOUT AND POWER SUPPLY BIASING**

It is always a good practice to use compact, minimum lead length layout design. The leads to the input should be as direct as possible with a minimum conductor length. Ground paths should have low resistance and low inductance. It is also good practice to bypass the power supplies with quality capacitors. Apply low equivalent series resistance (ESR) 1  $\mu\text{F}$  to 10  $\mu\text{F}$  tantalum or electrolytic capacitors at the supplies to minimize any transient disturbance and to filter low frequency ripple. Figure 46 illustrates the basic supply bypassing configuration for the AD5111/AD5113/AD5115.

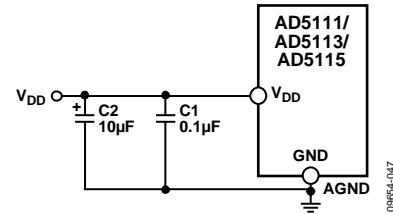
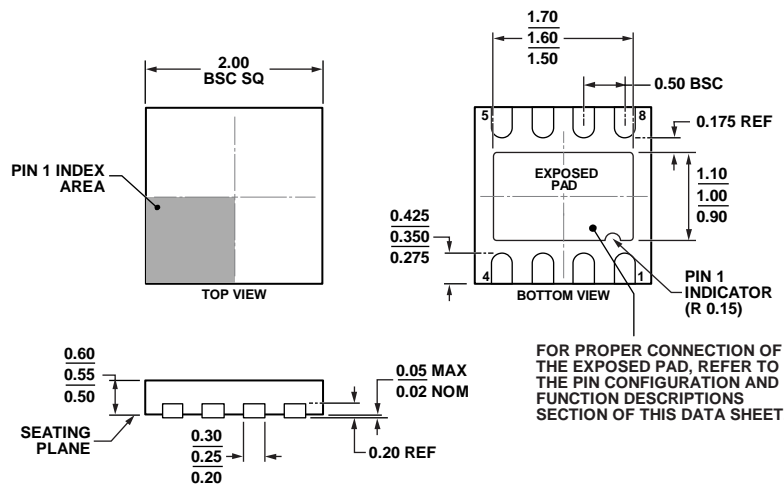

Figure 46. Power Supply Bypassing

OUTLINE DIMENSIONS



07-11-2011-B

Figure 47. 8-Lead Frame Chip Scale Package [LFCSP\_UD]  
 2 mm × 2 mm Body, Very Thin, Dual Lead (CP-8-10)  
 Dimensions shown in millimeters

ORDERING GUIDE

Model <sup>1,2</sup>	R <sub>AB</sub> (kΩ)	Resolution	Temperature Range	Package Description	Package Option	Branding Code
AD5111BCPZ10-RL7	10	128	-40°C to +125°C	8-Lead LFCSP_UD	CP-8-10	7S
AD5111BCPZ10-500R7	10	128	-40°C to +125°C	8-Lead LFCSP_UD	CP-8-10	7S
AD5111BCPZ80-RL7	80	128	-40°C to +125°C	8-Lead LFCSP_UD	CP-8-10	7T
AD5111BCPZ80-500R7	80	128	-40°C to +125°C	8-Lead LFCSP_UD	CP-8-10	7T
AD5113BCPZ5-RL7	5	64	-40°C to +125°C	8-Lead LFCSP_UD	CP-8-10	85
AD5113BCPZ5-500R7	5	64	-40°C to +125°C	8-Lead LFCSP_UD	CP-8-10	85
AD5113BCPZ10-RL7	10	64	-40°C to +125°C	8-Lead LFCSP_UD	CP-8-10	84
AD5113BCPZ10-500R7	10	64	-40°C to +125°C	8-Lead LFCSP_UD	CP-8-10	84
AD5113BCPZ80-RL7	80	64	-40°C to +125°C	8-Lead LFCSP_UD	CP-8-10	86
AD5113BCPZ80-500R7	80	64	-40°C to +125°C	8-Lead LFCSP_UD	CP-8-10	86
AD5115BCPZ10-RL7	10	32	-40°C to +125°C	8-Lead LFCSP_UD	CP-8-10	7Y
AD5115BCPZ10-500R7	10	32	-40°C to +125°C	8-Lead LFCSP_UD	CP-8-10	7Y
AD5115BCPZ80-RL7	80	32	-40°C to +125°C	8-Lead LFCSP_UD	CP-8-10	7Z
AD5115BCPZ80-500R7	80	32	-40°C to +125°C	8-Lead LFCSP_UD	CP-8-10	7Z
EVAL-AD5111SDZ				Evaluation Board		

<sup>1</sup> Z = RoHS Compliant Part.  
<sup>2</sup> The EVAL-AD5111SDZ has an R<sub>AB</sub> of 10 kΩ.

**NOTES**

NOTES