

1 2 3 4 5 6

A

B

C

D

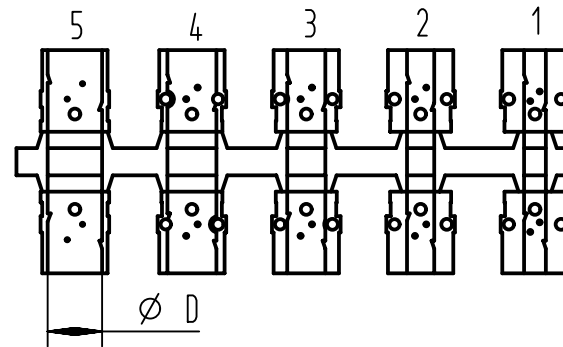
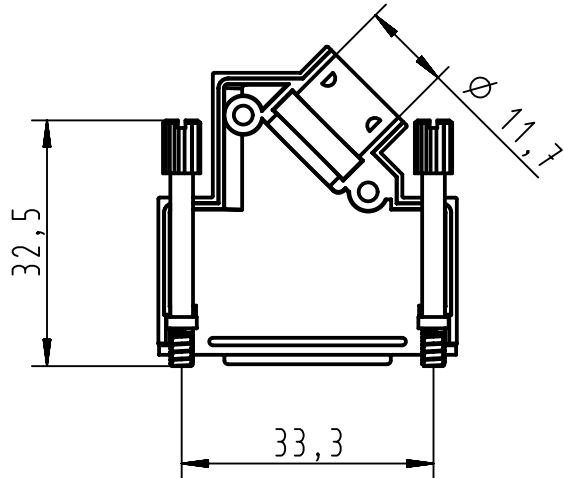
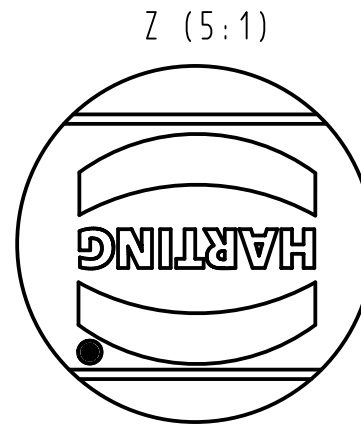
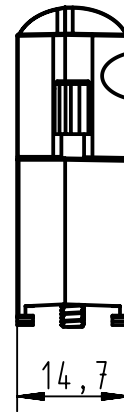
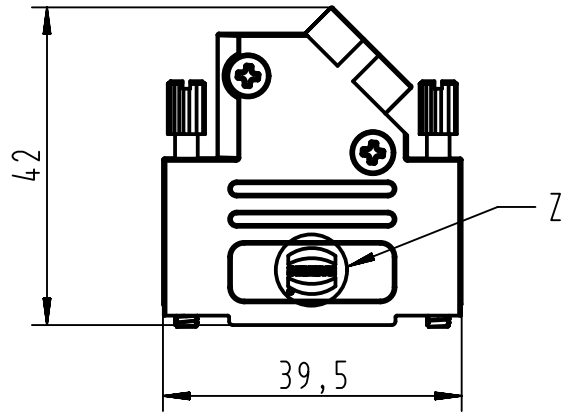

Grommet dimensions	
Number	Diameter D
1	4,0
2	5,0
3	7,0
4	9,0
5	10,2

	All rights reserved Department EC PD - FR	All Dimensions in mm Original Size DIN A4		Scale 1:1	Free size tol.	Ref.	
		HARTING Electronics GmbH D-32339 Espelkamp	Created by DOUGE	Inspected by BAGDIKIAN	Standardisation KOHLER	Date 2013-01-29	State Final Release
Part number 09 67 015 0333 screw thread 4-40 UNC		Title D-Sub Hood 15P side entry full metal				Doc-Key / ECM-Nr. 100521372/UGD/001/A 500000056836	
		Type TB	Number 09670150333			Rev. A	Page 1/1