

5

4

3

2

1

Hood upper part

Hood lower part

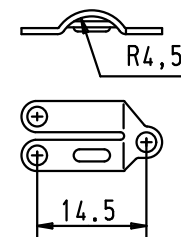
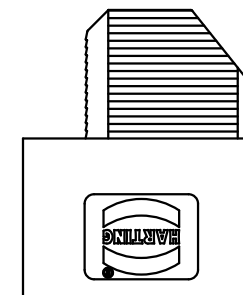
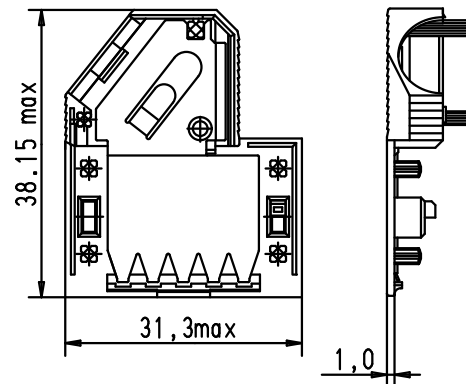
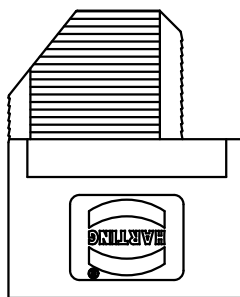
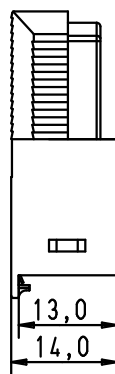
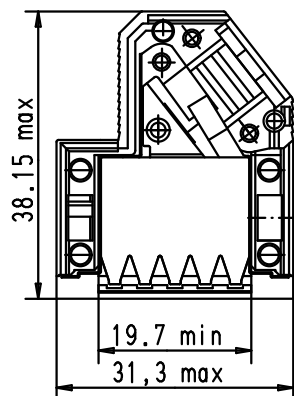

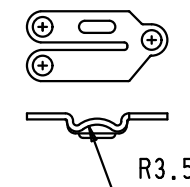

Strain relief 1

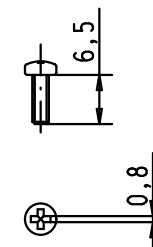

Strain relief 2



Flathead screw

				Det.	Name	 All Dim. in mm Orig. Size DIN A 4	D-Sub Hoods 9 POLES with SHELL	Maßstab/ Scale
			Insp.					1 : 1
			Stand.					
EC01696	20/04/10	SC						
31392	27/02/03	S.H.	HARTING EURL F-95972 Paris				TB 09 67 009 0573	Blatt/ Page
Mod.	Dat.	Name					Sub.	1 / 1

D

C

B

A