

D-SUB coupling - VS-15-KU-BU/BU - 1689653

Please be informed that the data shown in this PDF Document is generated from our Online Catalog. Please find the complete data in the user's documentation. Our General Terms of Use for Downloads are valid (<http://download.phoenixcontact.com>)



D-SUB coupling, shell size 2, socket, gender changer, shielded, connection direction straight, IP67 degree of protection



Key commercial data

Packing unit	1 1
Minimum order quantity	5 1
Weight per Piece (excluding packing)	28.4 GRM
Custom tariff number	85366990
Country of origin	Germany

Technical data

Mechanical characteristics

Number of positions	15
Insertion/withdrawal cycles	≥ 200
Cable exit	Straight
Color	gray

Ambient conditions

Ambient temperature (operation)	-40 °C ... 80 °C
Degree of protection	IP67

Material data

Inflammability class according to UL 94	V0
Housing material	PA
Contact carrier material	Polyester GF
Contact material	Copper alloy
Contact surface material	Hard gold-plated over nickel
Sealing material	EPDM

D-SUB coupling - VS-15-KU-BU/BU - 1689653

Technical data

Material data

Seal material	EPDM
---------------	------

Electrical characteristics

Rated voltage (III/3)	125 V
Rated current	5 A

Classifications

eCl@ss

eCl@ss 4.0	27140816
eCl@ss 4.1	27260701
eCl@ss 5.0	27260701
eCl@ss 5.1	27260701
eCl@ss 6.0	27261203
eCl@ss 7.0	27440202
eCl@ss 8.0	27440202

ETIM

ETIM 2.0	EC000437
ETIM 3.0	EC000437
ETIM 4.0	EC000437
ETIM 5.0	EC000437

UNSPSC

UNSPSC 6.01	31261501
UNSPSC 7.0901	31261501
UNSPSC 11	31261501
UNSPSC 12.01	31261501
UNSPSC 13.2	31261501

Accessories

Accessories

Protective cover

D-SUB coupling - VS-15-KU-BU/BU - 1689653

Accessories

D-SUB protective cover - VS-15-SD - 1887099



D-SUB protective cover, shell size 2, IP54 degree of protection, for panel mounting frame and sleeve housing VS-15-...

Drawings

Dimensioned drawing

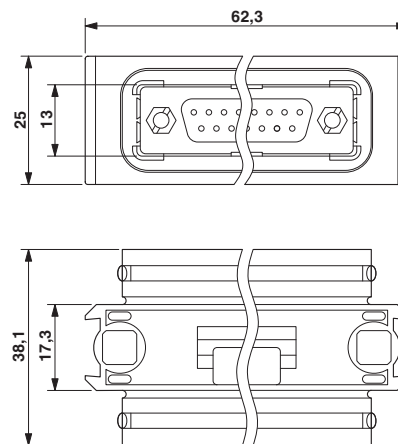

D-SUB coupling