

5

4

3

2

1

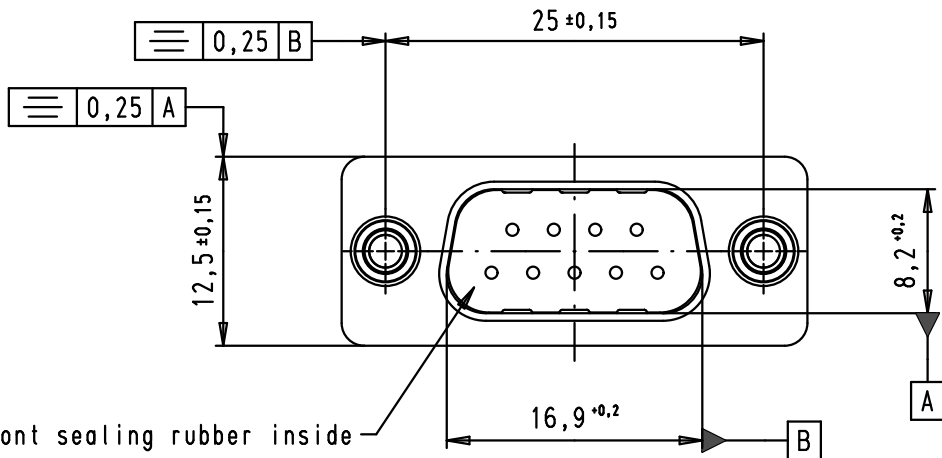

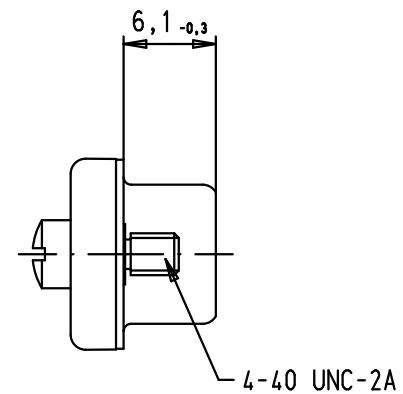
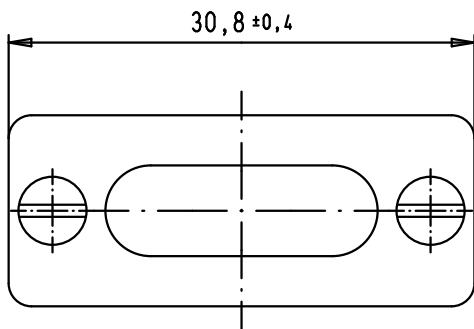
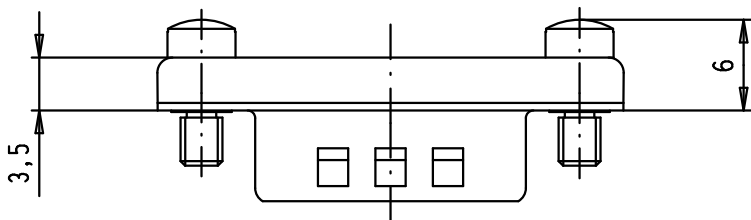

Front sealing rubber inside

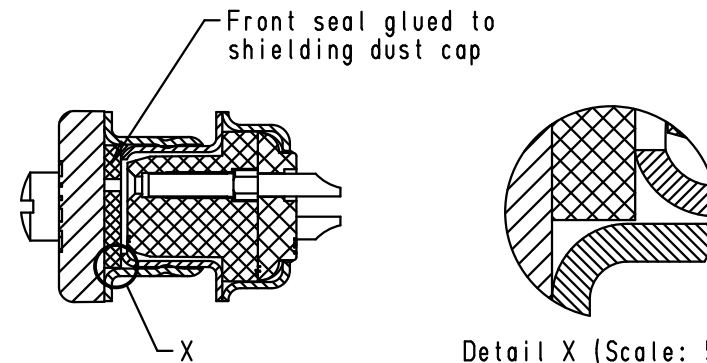

IP 67 shielding concept

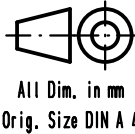

Detail X (Scale: 5:1)

				Dot.	Name	 <p>All Dim. in mm Orig. Size DIN A 4</p>	IP 67 male metal shielding cap, tin plated shell with dimples for 9 poles female D-Sub with screw locks	Maßstab/ Scale
			Detail.	05/04/07	PK			2:1
			Insp.					
			Stand.					
34906	18/04/08	PK	HARTING EURL F-95972 Paris				TB 09 67 002 9050	Blatt/ Page
33977	05/04/07	PK						1 / 1
Mod.	Dot.	Name						Sub.

D

C

B

A