

Description

The ZXCT1030 is a high side current sense monitor containing an internal reference and comparator with a non-latching output. Using this device eliminates the need to disrupt the ground plane when sensing a load current.

The wide input voltage range of 20V down to as low as 2.2V make it suitable for a range of applications. Dynamics and supply current are optimized for the processing of fast pulses, associated with switch mode applications.

Pin Assignments

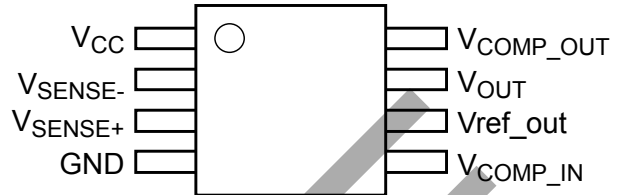

Features

- Low cost, accurate high-side current sensing
- Output voltage scaling
- Up to 18V output
- 2.2V - 20V supply range
- Voltage reference on chip
- Comparator on chip
- SO8 package

Applications

- Battery chargers
- Electronic fuse
- DC motor control
- Over current monitor
- Power management
- Inrush current limiting

Typical Application Circuit

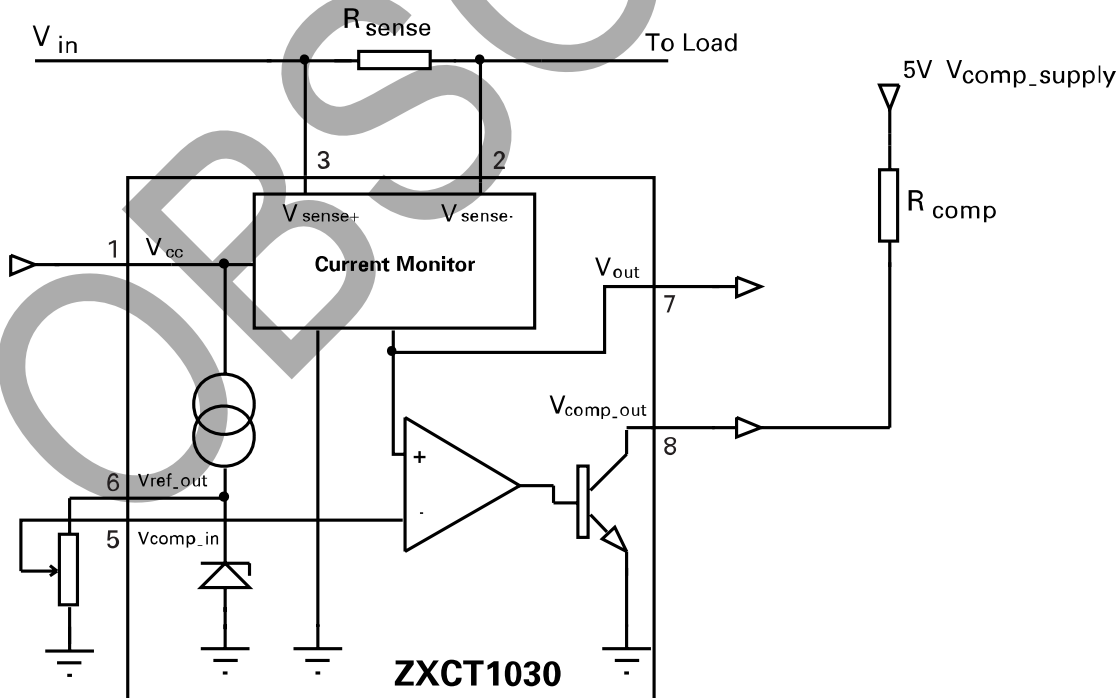

Pin Description

Pin Name	Function
V _{CC}	Supply voltage
V _{SENSE-}	Negative sense input
V _{SENSE+}	Positive sense input
GND	Ground
V _{COMP_IN}	Comparator input, usually a ratio of the reference or other control signal
V _{REF_OUT}	Reference output
V _{OUT}	Current monitor output voltage
V _{COMP_OUT}	Open collector comparator output

Absolute Maximum Ratings

Parameter	Rating	Unit
Voltage on any pin	-0.6 and V _{CC} +0.6	V
Operating Temperature	-40 to 85	°C
Storage Temperature	-55 to 125	°C
Package Power Dissipation	(T _{AMB} = 25)	°C
SO8	700	mW

Recommended Operating Conditions

Parameter	Min	Max	Units
V _{CC}	2.2	20	V
V _{SENSE+}	2.2	V _{CC}	V
V _{SENSE} ^(a)	10	500	mV
V _{OUT}	0	V _{SENSE-} -1V	V
V _{COMP_IN}	0.005	10	V
T _{AMB}	-40	85	°C

Electrical Characteristics (ZXCT1030N8) – Test conditions $T_{AMB} = 25^{\circ}\text{C}$, $V_{IN} = V_{CC} = 15\text{V}$, $R_{COMP} = 10\text{k}\Omega$,

 $V_{COMP_SUPPLY} = 5\text{V}$ unless otherwise stated.

Symbol	Parameter	Condition	Min.	Typ.	Max.	Unit
V_{CC}	V_{CC} Range		2.2		20	V
V_{SENSE+}	Sense+ Range		2.2		V_{CC}	
V_{OUT}	Output Voltage	$V_{SENSE} = 0$ $V_{SENSE} = 10$ $V_{SENSE} = 30$ $V_{SENSE} = 50$ $V_{SENSE} = 100$ $V_{SENSE} = 500$	0 88 284 480 970 4500	2 100 300 500 1000 5000	10 112 316 520 1030 5500	mV
R_{OUT}	Output Resistance	$V_{SENSE-} = 15\text{V}$, $V_{OUT} = 1\text{V}$	1.2	1.5	1.8	k Ω
V_{OUT} T_C	V_{OUT} Temperature Coefficient			30		ppm/ $^{\circ}\text{C}$
I_{CC}	Supply Current	$V_{SENSE-} = 15\text{V}$	170	270	350	μA
I_{SENSE+}	V_{SENSE+} Input Current			48	90	μA
I_{SENSE-}	V_{SENSE-} Input Current	$V_{SENSE-} = 14.9\text{V}$		70	220	nA
$V_{CM(MIN)}^{(B)}$	Minimum Active Common Mode Voltage	$V_{CC} = 15\text{V}$ $V_{COMP_SUPPLY} = 5\text{V}$ $V_{COMP_IN} = V_{REF}$ $V_{SENSE} = 10\text{mV}$	2.8			V
A_{CC}	Accuracy	$V_{SENSE} = 100\text{mV}$	-3		3	%
GAIN	V_{OUT}/V_{SENSE}	$V_{SENSE} = 100\text{mV}$	9.7	10.0	10.3	
BW	Bandwidth	$V_{SENSE} = 10\text{mVp-p}$ $V_{SENSE} = 100\text{mVp-p}$		3 6		MHz
COMPARATOR						
V_{COMP_IN}	Input Voltage		0.005		10	V
V_H	Hysteresis			15		mV
I_B	Input Bias		5	80	150	nA
T_D	Propagation Delay			100		ns
V_{OL}	Output Voltage Low		30	150	200	mV
V_{OH}	Output Voltage High				V_{COMP_SUPPLY}	
I_{OL}	Output Sink Current	$V_{ol} = 0.4\text{V}$	2			mA
I_{OH}	Output High Leakage Current				1.0	μA
Voltage Reference						
V_{REF}		Reference Current = +300 μA to -5 μA	1.200	1.240	1.280	V
Delta V_{REF}	Change in V_{REF}	SOURCE 5 μA to SINK 300 μA		10		mV
T_C				30		ppm/ $^{\circ}\text{C}$
PSR	Supply Rejection			0.01		%/V

Notes: (a) $(V_{SENSE+}) - (V_{SENSE-})$
 (b) Level of V_{SENSE+} where comparator output defaults to 'off'.

OBSOLETE – PART DISCONTINUED

Typical Application Circuits

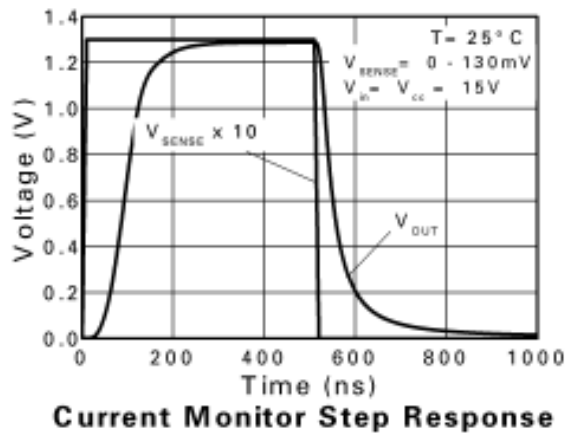
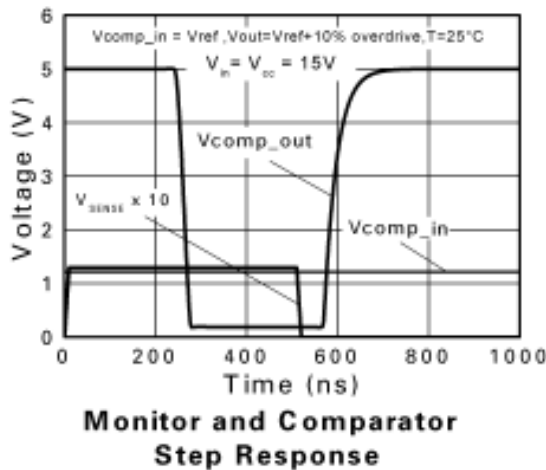
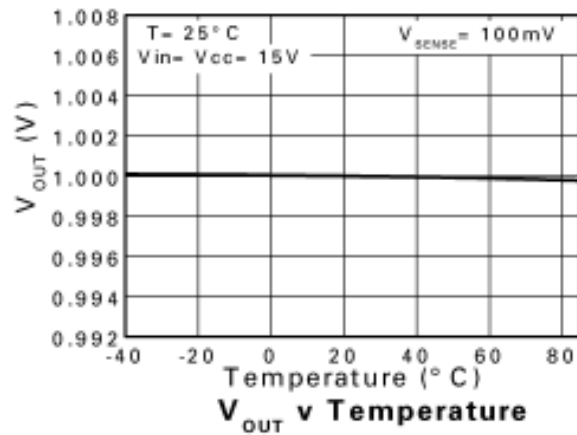
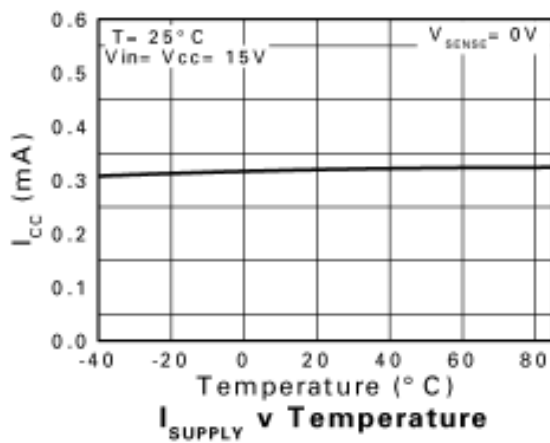
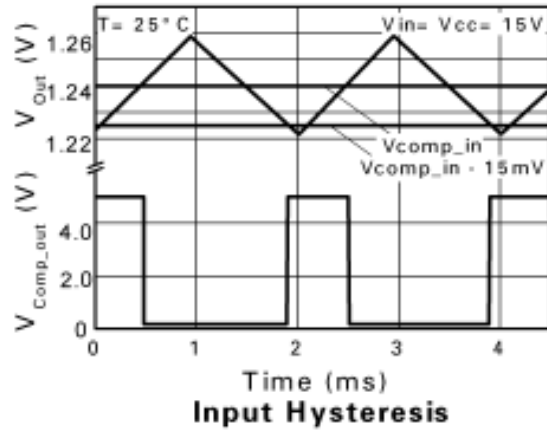
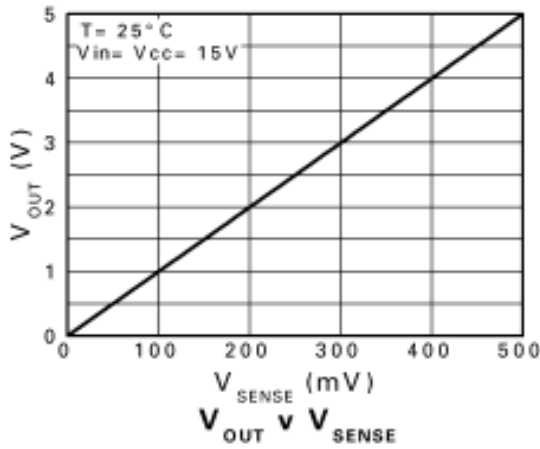

Voltage output current monitor

Referring to the block diagram, the current monitor takes the small voltage developed across the sense resistor (V_{SENSE}) and transfers it from the large common mode supply voltage to a ground referenced signal with a gain of 10. The sense input common mode range is 2.2V to 20V. In this range, a linear output voltage is delivered.

Reference

The bandgap reference allows the comparator to compare the translated V_{SENSE} with threshold value chosen by the user which can be any voltage from 0 to 1.24V, configured by two external resistors which forms V_{COMP_IN} .

The output current which can be drawn from the comparator reference (I_{REF} source) is limited to 5 μ A, making potentiometers $\geq 250k\Omega$ suitable for setting a threshold level. Where a lower potentiometer resistor value is used, an additional resistor value should be inserted between V_{REF} and V_{CC} to maintain sufficient current for the reference. (as shown in Figure 1).

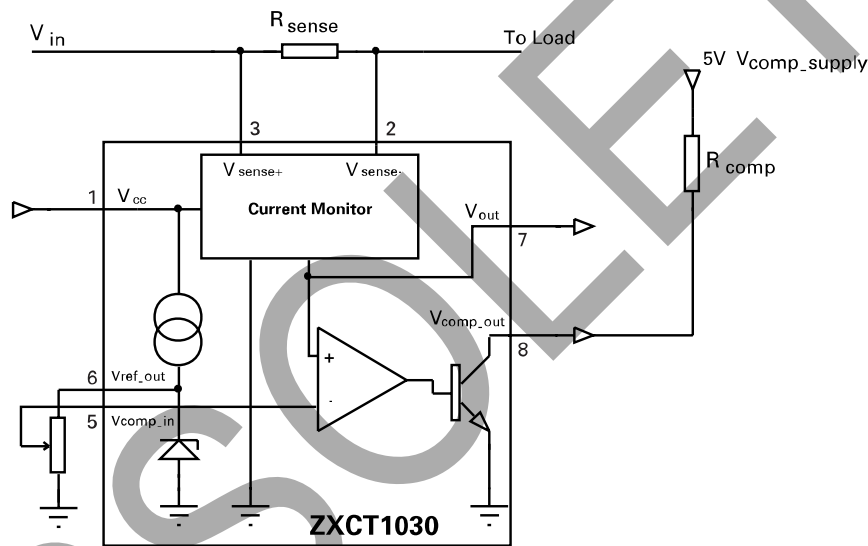

Figure 1: External Resistor for Reference Level

The voltage reference has a maximum current sink capability. This magnitude of current will be influenced by the value of R_1 which is inserted between V_{REF} and V_{CC} . The value of current flowing through R_1 can be expressed as:

$$I = (V_{CC} - V_{REF}) / R_1$$

Comparator

The open collector output is active low and is asserted when $V_{SENSE} \times 10 (V_{OUT}) > V_{COMP_IN}$. It can be connected to any voltage rail up to V_{IN} via a pull-up resistor. Suggest values for the resistor are in the range of 10-100k Ω .

In the case where high load currents or a short circuit occurs, thus reducing the common mode signals ($V+$, $V-$) typically below 2.2V, the comparator will default to the asserted state. This can eliminate a closed loop system 'latch-up' condition, allowing the controller to remove the applied power.

Stability

To ensure stable operation of the ZXCT1030, it is recommended a decoupling capacitor is placed across the V_{CC} and ground connections. A ceramic 10 μ F will be adequate.

Ordering Information*

Device	Status(*)	Package	Device Marking	Reel Size (inches)	Tape Width (mm)	Quantity Per reel
ZXCT1030X8TA	Obsolete	MSOP8	ZXCT1030	7	12	1000
ZXCT1030N8TA	Active	SO8	ZXCT1030	7	12	500

Notes: *ZXCT1030X8TA is obsolete for more device information please check our obsolete products search on diodes website

OBSOLETE - PART DISCONTINUED

Package Outline – SO8

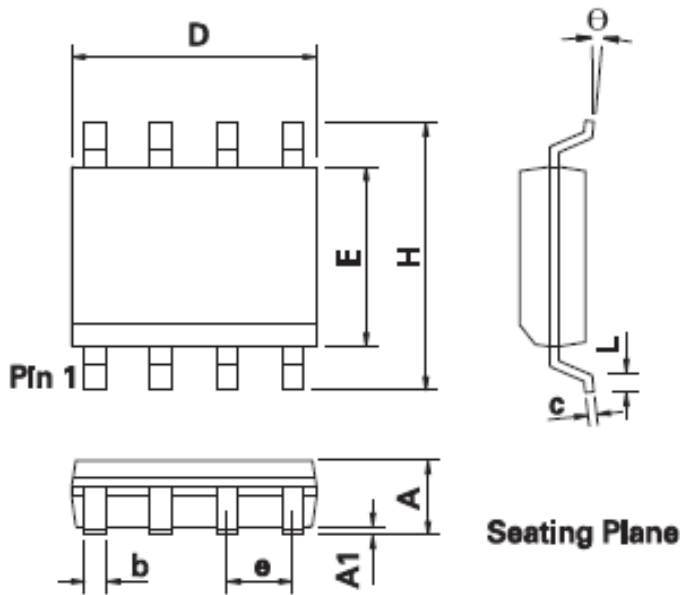

DIM	Inches		Millimeters		DIM	Inches		Millimeters	
	Min.	Max.	Min.	Max.		Min.	Max.	Min.	Max.
A	0.053	0.069	1.35	1.75	e	0.050 BSC		1.27 BSC	
A1	0.004	0.010	0.10	0.25	b	0.013	0.020	0.33	0.51
D	0.189	0.197	4.80	5.00	c	0.008	0.010	0.19	0.25
H	0.228	0.244	5.80	6.20	theta	0°	8°	0°	8°
E	0.150	0.157	3.80	4.00	h	0.010	0.020	0.25	0.50
L	0.016	0.050	0.40	1.27	-	-	-	-	-

Note: Controlling dimensions are in inches. Approximate dimensions are provided in millimeters

IMPORTANT NOTICE

1. DIODES INCORPORATED AND ITS SUBSIDIARIES (“DIODES”) MAKE NO WARRANTY OF ANY KIND, EXPRESS OR IMPLIED, WITH REGARDS TO ANY INFORMATION CONTAINED IN THIS DOCUMENT, INCLUDING, BUT NOT LIMITED TO, THE IMPLIED WARRANTIES OF MERCHANTABILITY, FITNESS FOR A PARTICULAR PURPOSE OR NON-INFRINGEMENT OF THIRD PARTY INTELLECTUAL PROPERTY RIGHTS (AND THEIR EQUIVALENTS UNDER THE LAWS OF ANY JURISDICTION).
2. The Information contained herein is for informational purpose only and is provided only to illustrate the operation of Diodes products described herein and application examples. Diodes does not assume any liability arising out of the application or use of this document or any product described herein. This document is intended for skilled and technically trained engineering customers and users who design with Diodes products. Diodes products may be used to facilitate safety-related applications; however, in all instances customers and users are responsible for (a) selecting the appropriate Diodes products for their applications, (b) evaluating the suitability of the Diodes products for their intended applications, (c) ensuring their applications, which incorporate Diodes products, comply the applicable legal and regulatory requirements as well as safety and functional-safety related standards, and (d) ensuring they design with appropriate safeguards (including testing, validation, quality control techniques, redundancy, malfunction prevention, and appropriate treatment for aging degradation) to minimize the risks associated with their applications.
3. Diodes assumes no liability for any application-related information, support, assistance or feedback that may be provided by Diodes from time to time. Any customer or user of this document or products described herein will assume all risks and liabilities associated with such use, and will hold Diodes and all companies whose products are represented herein or on Diodes’ websites, harmless against all damages and liabilities.
4. Products described herein may be covered by one or more United States, international or foreign patents and pending patent applications. Product names and markings noted herein may also be covered by one or more United States, international or foreign trademarks and trademark applications. Diodes does not convey any license under any of its intellectual property rights or the rights of any third parties (including third parties whose products and services may be described in this document or on Diodes’ website) under this document.
5. Diodes products are provided subject to Diodes’ Standard Terms and Conditions of Sale (<https://www.diodes.com/about/company/terms-and-conditions/terms-and-conditions-of-sales/>) or other applicable terms. This document does not alter or expand the applicable warranties provided by Diodes. Diodes does not warrant or accept any liability whatsoever in respect of any products purchased through unauthorized sales channel.
6. Diodes products and technology may not be used for or incorporated into any products or systems whose manufacture, use or sale is prohibited under any applicable laws and regulations. Should customers or users use Diodes products in contravention of any applicable laws or regulations, or for any unintended or unauthorized application, customers and users will (a) be solely responsible for any damages, losses or penalties arising in connection therewith or as a result thereof, and (b) indemnify and hold Diodes and its representatives and agents harmless against any and all claims, damages, expenses, and attorney fees arising out of, directly or indirectly, any claim relating to any noncompliance with the applicable laws and regulations, as well as any unintended or unauthorized application.
7. While efforts have been made to ensure the information contained in this document is accurate, complete and current, it may contain technical inaccuracies, omissions and typographical errors. Diodes does not warrant that information contained in this document is error-free and Diodes is under no obligation to update or otherwise correct this information. Notwithstanding the foregoing, Diodes reserves the right to make modifications, enhancements, improvements, corrections or other changes without further notice to this document and any product described herein. This document is written in English but may be translated into multiple languages for reference. Only the English version of this document is the final and determinative format released by Diodes.
8. Any unauthorized copying, modification, distribution, transmission, display or other use of this document (or any portion hereof) is prohibited. Diodes assumes no responsibility for any losses incurred by the customers or users or any third parties arising from any such unauthorized use.

Copyright © 2021 Diodes Incorporated

www.diodes.com