

Rochester Electronics Manufactured Components

Rochester branded components are manufactured using either die/wafers purchased from the original suppliers or Rochester wafers recreated from the original IP. All recreations are done with the approval of the OCM.

Parts are tested using original factory test programs or Rochester developed test solutions to guarantee product meets or exceed the OCM data sheet.

Quality Overview

- ISO-9001
- AS9120 certification
- Qualified Manufacturers List (QML) MIL-PRF-35835
 - Class Q Military
 - Class V Space Level
- Qualified Suppliers List of Distributors (QSLD)
 - Rochester is a critical supplier to DLA and meets all industry and DLA standards.

Rochester Electronics, LLC is committed to supplying products that satisfy customer expectations for quality and are equal to those originally supplied by industry manufacturers.

The original manufacturer's datasheet accompanying this document reflects the performance and specifications of the Rochester manufactured version of this device. Rochester Electronics guarantees the performance of its semiconductor products to the original OEM specifications. 'Typical' values are for reference purposes only. Certain minimum or maximum ratings may be based on product characterization, design, simulation, or sample testing.

SN74LS161A, SN74LS163A

BCD Decade Counters/ 4-Bit Binary Counters

The LS161A/163A are high-speed 4-bit synchronous counters. They are edge-triggered, synchronously presettable, and cascadable MSI building blocks for counting, memory addressing, frequency division and other applications. The LS161A and LS163A count modulo 16 (binary).

The LS161A has an asynchronous Master Reset (Clear) input that overrides, and is independent of, the clock and all other control inputs. The LS163A has a Synchronous Reset (Clear) input that overrides all other control inputs, but is active only during the rising clock edge.

	Binary (Modulo 16)
Asynchronous Reset	LS161A
Synchronous Reset	LS163A

- Synchronous Counting and Loading
- Two Count Enable Inputs for High Speed Synchronous Expansion
- Terminal Count Fully Decoded
- Edge-Triggered Operation
- Typical Count Rate of 35 MHz
- ESD > 3500 Volts

GUARANTEED OPERATING RANGES

Symbol	Parameter	Min	Typ	Max	Unit
V _{CC}	Supply Voltage	4.75	5.0	5.25	V
T _A	Operating Ambient Temperature Range	0	25	70	°C
I _{OH}	Output Current – High			-0.4	mA
I _{OL}	Output Current – Low			8.0	mA



ON Semiconductor™

<http://onsemi.com>

LOW POWER SCHOTTKY

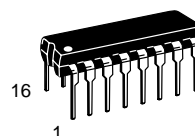

PLASTIC
N SUFFIX
CASE 648

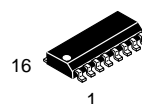

SOIC
D SUFFIX
CASE 751B

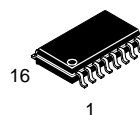

SOEIAJ
M SUFFIX
CASE 966

ORDERING INFORMATION

Device	Package	Shipping
SN74LS161AN	16 Pin DIP	2000 Units/Box
SN74LS161AD	SOIC-16	38 Units/Rail
SN74LS161ADR2	SOIC-16	2500/Tape & Reel
SN74LS161AM	SOEIAJ-16	See Note 1
SN74LS161AMEL	SOEIAJ-16	See Note 1
SN74LS163AN	16 Pin DIP	2000 Units/Box
SN74LS163AD	SOIC-16	38 Units/Rail
SN74LS163ADR2	SOIC-16	2500/Tape & Reel
SN74LS163AM	SOEIAJ-16	See Note 1
SN74LS163AMEL	SOEIAJ-16	See Note 1

1. For ordering information on the EIAJ version of the SOIC package, please contact your local ON Semiconductor representative.

SN74LS161A, SN74LS163A

CONNECTION DIAGRAM DIP (TOP VIEW)

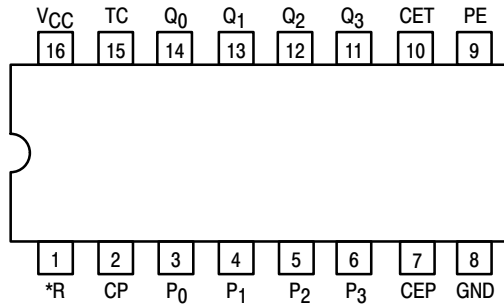

NOTE:
The Flatpak version has the same pinouts (Connection Diagram) as the Dual In-Line Package.

*MR for LS161A
*SR for LS163A

PIN NAMES

PE	Parallel Enable (Active LOW) Input
P ₀ - P ₃	Parallel Inputs
CEP	Count Enable Parallel Input
CET	Count Enable Trickle Input
CP	Clock (Active HIGH Going Edge) Input
MR	Master Reset (Active LOW) Input
SR	Synchronous Reset (Active LOW) Input
Q ₀ - Q ₃	Parallel Outputs
TC	Terminal Count Output

LOADING (Note a)

	HIGH	LOW
PE	1.0 U.L.	0.5 U.L.
P ₀ - P ₃	0.5 U.L.	0.25 U.L.
CEP	0.5 U.L.	0.25 U.L.
CET	1.0 U.L.	0.5 U.L.
CP	0.5 U.L.	0.25 U.L.
MR	0.5 U.L.	0.25 U.L.
SR	1.0 U.L.	0.5 U.L.
Q ₀ - Q ₃	10 U.L.	5 U.L.
TC	10 U.L.	5 U.L.

NOTES:

a) 1 TTL Unit Load (U.L.) = 40 μ A HIGH/1.6 mA LOW.

LOGIC SYMBOL

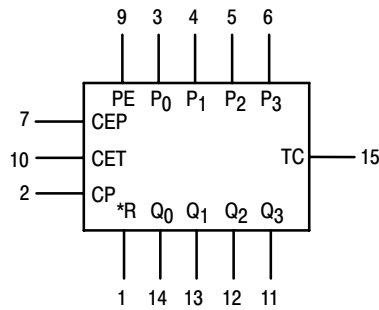

V_{CC} = PIN 16
GND = PIN 8

*MR for LS161A
*SR for LS163A

SN74LS161A, SN74LS163A

STATE DIAGRAM

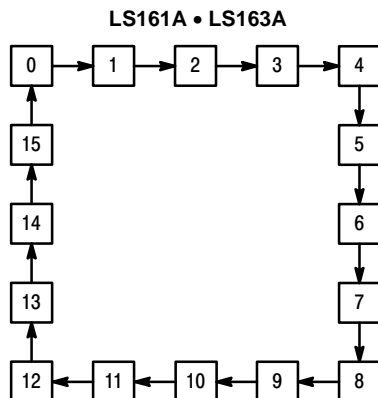

LOGIC EQUATIONS

Count Enable = $CEP \cdot CET \cdot PE$
 TC for LS161A & LS163A = $CET \cdot Q_0 \cdot Q_1 \cdot Q_2 \cdot Q_3$
 Preset = $\overline{PE} \cdot CP + (\text{rising clock edge})$
 Reset = \overline{MR} (LS161A)
 Reset = $SR \cdot CP + (\text{rising clock edge})$ (LS163A)

FUNCTIONAL DESCRIPTION

The LS161A/163A are 4-bit synchronous counters with a synchronous Parallel Enable (Load) feature. The counters consist of four edge-triggered D flip-flops with the appropriate data routing networks feeding the D inputs. All changes of the Q outputs (except due to the asynchronous Master Reset in the LS161A) occur as a result of, and synchronous with, the LOW to HIGH transition of the Clock input (CP). As long as the set-up time requirements are met, there are no special timing or activity constraints on any of the mode control or data inputs.

Three control inputs — Parallel Enable (\overline{PE}), Count Enable Parallel (CEP) and Count Enable Trickle (CET) — select the mode of operation as shown in the tables below. The Count Mode is enabled when the CEP, CET, and PE inputs are HIGH. When the PE is LOW, the counters will synchronously load the data from the parallel inputs into the flip-flops on the LOW to HIGH transition of the clock. Either the CEP or CET can be used to inhibit the count sequence. With the PE held HIGH, a LOW on either the CEP or CET inputs at least one set-up time prior to the LOW to HIGH clock transition will cause the existing output states to be retained. The AND feature of the two Count Enable inputs ($CET \cdot CEP$) allows synchronous cascading without external gating and without delay accumulation over any practical number of bits or digits.

The Terminal Count (TC) output is HIGH when the Count Enable Trickle (CET) input is HIGH while the counter is in its maximum count state (HLLH for the BCD counters, HHHH for the Binary counters). Note that TC is fully decoded and will, therefore, be HIGH only for one count state.

The LS161A and LS163A count modulo 16 following a binary sequence. They generate a TC when the CET input is HIGH while the counter is in state 15 (HHHH). From this state they increment to state 0 (LLLL).

The Master Reset (MR) of the LS161A is asynchronous. When the MR is LOW, it overrides all other input conditions and sets the outputs LOW. The MR pin should never be left open. If not used, the MR pin should be tied through a resistor to V_{CC} , or to a gate output which is permanently set to a HIGH logic level.

The active LOW Synchronous Reset (SR) input of the LS163A acts as an edge-triggered control input, overriding CET, CEP and PE, and resetting the four counter flip-flops on the LOW to HIGH transition of the clock. This simplifies the design from race-free logic controlled reset circuits, e.g., to reset the counter synchronously after reaching a predetermined value.

MODE SELECT TABLE

*SR	PE	CET	CEP	Action on the Rising Clock Edge ()
L	X	X	X	RESET (Clear)
H	L	X	X	LOAD ($P_n \rightarrow Q_n$)
H	H	H	H	COUNT (Increment)
H	H	L	X	NO CHANGE (Hold)
H	H	X	L	NO CHANGE (Hold)

*For the LS163A only.

H = HIGH Voltage Level
 L = LOW Voltage Level
 X = Don't Care

SN74LS161A, SN74LS163A

LS161A

DC CHARACTERISTICS OVER OPERATING TEMPERATURE RANGE (unless otherwise specified)

Symbol	Parameter	Limits			Unit	Test Conditions
		Min	Typ	Max		
V _{IH}	Input HIGH Voltage	2.0			V	Guaranteed Input HIGH Voltage for All Inputs
V _{IL}	Input LOW Voltage			0.8	V	Guaranteed Input LOW Voltage for All Inputs
V _{IK}	Input Clamp Diode Voltage		-0.65	-1.5	V	V _{CC} = MIN, I _{IN} = -18 mA
V _{OH}	Output HIGH Voltage	2.7	3.5		V	V _{CC} = MIN, I _{OH} = MAX, V _{IN} = V _{IH} or V _{IL} per Truth Table
V _{OL}	Output LOW Voltage		0.25	0.4	V	I _{OL} = 4.0 mA
			0.35	0.5	V	I _{OL} = 8.0 mA
I _{IH}	Input HIGH Current MR, Data, CEP, Clock PE, CET			20 40	μA	V _{CC} = MAX, V _{IN} = 2.7 V
	MR, Data, CEP, Clock PE, CET			0.1 0.2	mA	V _{CC} = MAX, V _{IN} = 7.0 V
I _{IL}	Input LOW Current MR, Data, CEP, Clock PE, CET			-0.4 -0.8	mA	V _{CC} = MAX, V _{IN} = 0.4 V
I _{OS}	Short Circuit Current (Note 2)	-20		-100	mA	V _{CC} = MAX
I _{CC}	Power Supply Current Total, Output HIGH Total, Output LOW			31 32	mA	V _{CC} = MAX

2. Not more than one output should be shorted at a time, nor for more than 1 second.

LS163A

DC CHARACTERISTICS OVER OPERATING TEMPERATURE RANGE (unless otherwise specified)

Symbol	Parameter	Limits			Unit	Test Conditions
		Min	Typ	Max		
V _{IH}	Input HIGH Voltage	2.0			V	Guaranteed Input HIGH Voltage for All Inputs
V _{IL}	Input LOW Voltage			0.8	V	Guaranteed Input LOW Voltage for All Inputs
V _{IK}	Input Clamp Diode Voltage		-0.65	-1.5	V	V _{CC} = MIN, I _{IN} = -18 mA
V _{OH}	Output HIGH Voltage	2.7	3.5		V	V _{CC} = MIN, I _{OH} = MAX, V _{IN} = V _{IH} or V _{IL} per Truth Table
V _{OL}	Output LOW Voltage		0.25	0.4	V	I _{OL} = 4.0 mA
			0.35	0.5	V	I _{OL} = 8.0 mA
I _{IH}	Input HIGH Current Data, CEP, Clock PE, CET, SR			20 40	μA	V _{CC} = MAX, V _{IN} = 2.7 V
	Data, CEP, Clock PE, CET, SR			0.1 0.2	mA	V _{CC} = MAX, V _{IN} = 7.0 V
I _{IL}	Input LOW Current Data, CEP, Clock, PE, SR CET			-0.4 -0.8	mA	V _{CC} = MAX, V _{IN} = 0.4 V
I _{OS}	Short Circuit Current (Note 3)	-20		-100	mA	V _{CC} = MAX
I _{CC}	Power Supply Current Total, Output HIGH Total, Output LOW			31 32	mA	V _{CC} = MAX

3. Not more than one output should be shorted at a time, nor for more than 1 second.

AC CHARACTERISTICS (T_A = 25°C)

SN74LS161A, SN74LS163A

Symbol	Parameter	Limits			Unit	Test Conditions
		Min	Typ	Max		
f _{MAX}	Maximum Clock Frequency	25	32		MHz	V _{CC} = 5.0 V C _L = 15 pF
t _{PLH} t _{PHL}	Propagation Delay Clock to TC		20 18	35 35	ns	
t _{PLH} t _{PHL}	Propagation Delay Clock to Q		13 18	24 27	ns	
t _{PLH} t _{PHL}	Propagation Delay CET to TC		9.0 9.0	14 14	ns	
t _{PHL}	MR or SR to Q		20	28	ns	

AC SETUP REQUIREMENTS (T_A = 25°C)

Symbol	Parameter	Limits			Unit	Test Conditions
		Min	Typ	Max		
t _{WCP}	Clock Pulse Width Low	25			ns	V _{CC} = 5.0 V
t _W	MR or SR Pulse Width	20			ns	
t _S	Setup Time, other*	20			ns	
t _S	Setup Time PE or SR	25			ns	
t _H	Hold Time, data	3			ns	
t _H	Hold Time, other	0			ns	
t _{rec}	Recovery Time MR to CP	15			ns	

*CEP, CET, or DATA

DEFINITION OF TERMS

SETUP TIME (t_S) — is defined as the minimum time required for the correct logic level to be present at the logic input prior to the clock transition from LOW to HIGH in order to be recognized and transferred to the outputs.

HOLD TIME (t_H) — is defined as the minimum time following the clock transition from LOW to HIGH that the logic level must be maintained at the input in order to ensure

continued recognition. A negative HOLD TIME indicates that the correct logic level may be released prior to the clock transition from LOW to HIGH and still be recognized.

RECOVERY TIME (t_{rec}) — is defined as the minimum time required between the end of the reset pulse and the clock transition from LOW to HIGH in order to recognize and transfer HIGH Data to the Q outputs.

AC WAVEFORMS

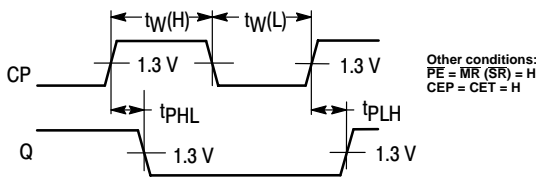

Figure 1. Clock to Output Delays, Count Frequency, and Clock Pulse Width

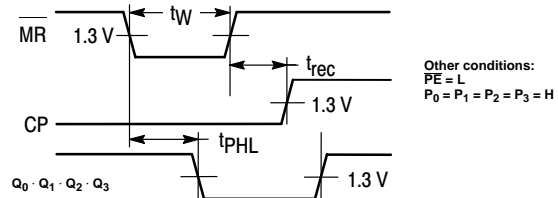

Figure 2. Master Reset to Output Delay, Master Reset Pulse Width, and Master Reset Recovery Time

SN74LS161A, SN74LS163A

AC WAVEFORMS (continued)

COUNT ENABLE TRICKLE INPUT TO TERMINAL COUNT OUTPUT DELAYS

The positive TC pulse occurs when the outputs are in the ($Q_0 \bullet Q_1 \bullet Q_2 \bullet Q_3$) state for the LS161 and LS163.

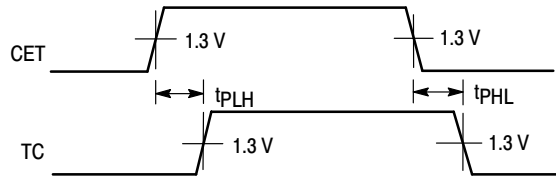

Figure 3.

CLOCK TO TERMINAL COUNT DELAYS

The positive TC pulse is coincident with the output state ($Q_0 \bullet Q_1 \bullet Q_2 \bullet Q_3$) for the LS161 and LS163.

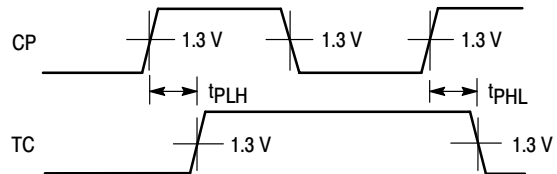

Figure 4.

SETUP TIME (t_s) AND HOLD TIME (t_h) FOR PARALLEL DATA INPUTS

The shaded areas indicate when the input is permitted to change for predictable output performance.

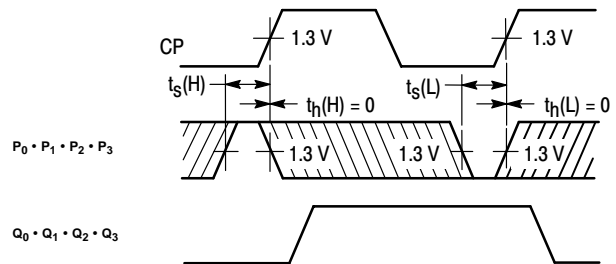

Figure 5.

SETUP TIME (t_s) AND HOLD TIME (t_h) FOR COUNT ENABLE (CEP) AND (CET) AND PARALLEL ENABLE (PE) INPUTS

The shaded areas indicate when the input is permitted to change for predictable output performance.

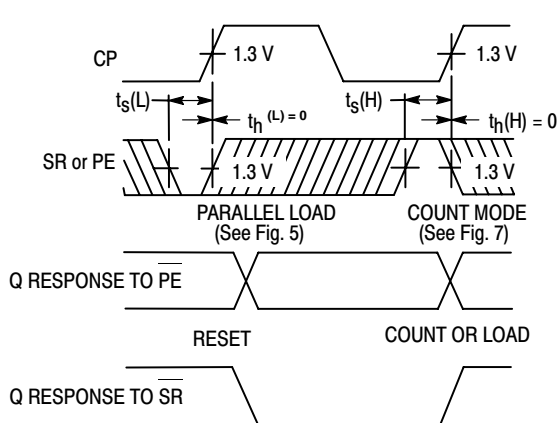

Figure 6.

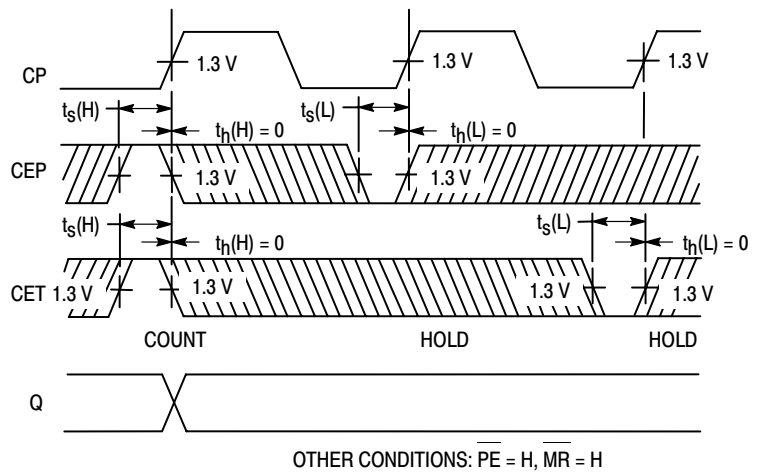
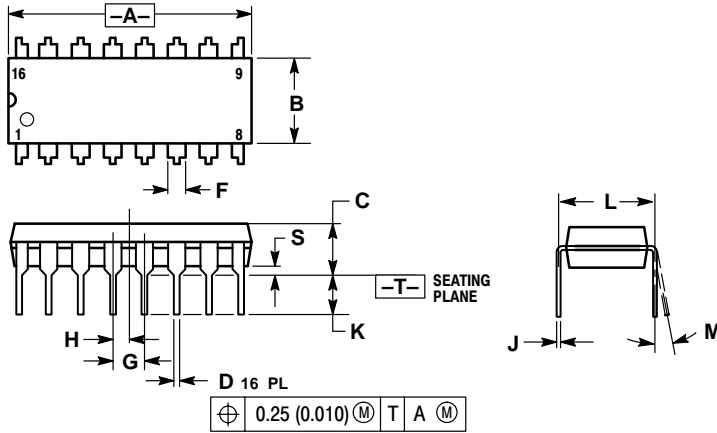

Figure 7.

SN74LS161A, SN74LS163A

PACKAGE DIMENSIONS

N SUFFIX PLASTIC PACKAGE CASE 648-08 ISSUE R



NOTES:

1. DIMENSIONING AND TOLERANCING PER ANSI Y14.5M, 1982.
2. CONTROLLING DIMENSION: INCH.
3. DIMENSION L TO CENTER OF LEADS WHEN FORMED PARALLEL.
4. DIMENSION B DOES NOT INCLUDE MOLD FLASH.
5. ROUNDED CORNERS OPTIONAL.

DIM	INCHES		MILLIMETERS	
	MIN	MAX	MIN	MAX
A	0.740	0.770	18.80	19.55
B	0.250	0.270	6.35	6.85
C	0.145	0.175	3.69	4.44
D	0.015	0.021	0.39	0.53
F	0.040	0.70	1.02	1.77
G	0.100 BSC		2.54 BSC	
H	0.050 BSC		1.27 BSC	
J	0.008	0.015	0.21	0.38
K	0.110	0.130	2.80	3.30
L	0.295	0.305	7.50	7.74
M	0° 10°		0° 10°	
S	0.020	0.040	0.51	1.01

D SUFFIX PLASTIC SOIC PACKAGE CASE 751B-05 ISSUE J

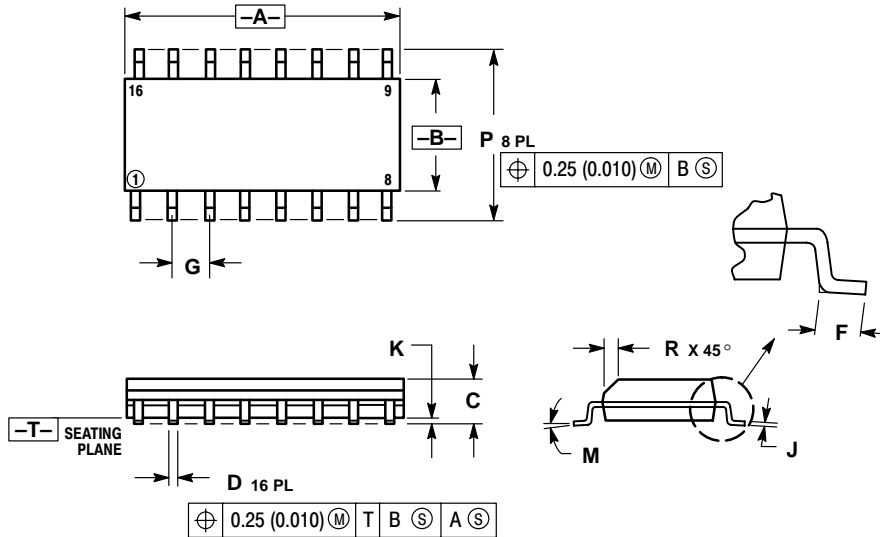

NOTES:

1. DIMENSIONING AND TOLERANCING PER ANSI Y14.5M, 1982.
2. CONTROLLING DIMENSION: MILLIMETER.
3. DIMENSIONS A AND B DO NOT INCLUDE MOLD PROTRUSION.
4. MAXIMUM MOLD PROTRUSION 0.15 (0.006) PER SIDE.
5. DIMENSION D DOES NOT INCLUDE DAMBAR PROTRUSION. ALLOWABLE DAMBAR PROTRUSION SHALL BE 0.127 (0.005) TOTAL IN EXCESS OF THE D DIMENSION AT MAXIMUM MATERIAL CONDITION.

DIM	MILLIMETERS		INCHES	
	MIN	MAX	MIN	MAX
A	9.80	10.00	0.386	0.393
B	3.80	4.00	0.150	0.157
C	1.35	1.75	0.054	0.068
D	0.35	0.49	0.014	0.019
F	0.40	1.25	0.016	0.049
G	1.27 BSC		0.050 BSC	
J	0.19	0.25	0.008	0.009
K	0.10	0.25	0.004	0.009
M	0° 7°		0° 7°	
P	5.80	6.20	0.229	0.244
R	0.25	0.50	0.010	0.019

SN74LS161A, SN74LS163A

PACKAGE DIMENSIONS

M SUFFIX
SOEIAJ PACKAGE
CASE 966-01
ISSUE O

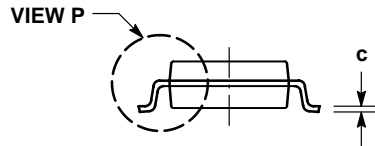
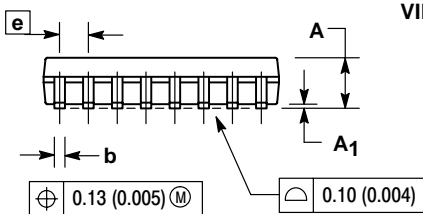
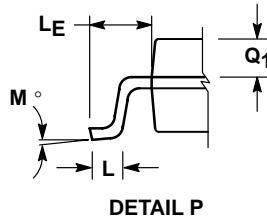
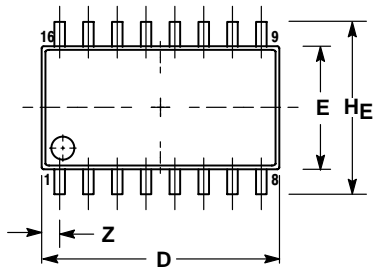

NOTES:

1. DIMENSIONING AND TOLERANCING PER ANSI Y14.5M, 1982.
2. CONTROLLING DIMENSION: MILLIMETER.
3. DIMENSIONS D AND E DO NOT INCLUDE MOLD FLASH OR PROTRUSIONS AND ARE MEASURED AT THE PARTING LINE. MOLD FLASH OR PROTRUSIONS SHALL NOT EXCEED 0.15 (0.006) PER SIDE.
4. TERMINAL NUMBERS ARE SHOWN FOR REFERENCE ONLY.
5. THE LEAD WIDTH DIMENSION (b) DOES NOT INCLUDE DAMBAR PROTRUSION. ALLOWABLE DAMBAR PROTRUSION SHALL BE 0.08 (0.003) TOTAL IN EXCESS OF THE LEAD WIDTH DIMENSION AT MAXIMUM MATERIAL CONDITION. DAMBAR CANNOT BE LOCATED ON THE LOWER RADIUS OR THE FOOT. MINIMUM SPACE BETWEEN PROTRUSIONS AND ADJACENT LEAD TO BE 0.46 (0.018).

DIM	MILLIMETERS		INCHES	
	MIN	MAX	MIN	MAX
A	---	2.05	---	0.081
A ₁	0.05	0.20	0.002	0.008
b	0.35	0.50	0.014	0.020
c	0.18	0.27	0.007	0.011
D	9.90	10.50	0.390	0.413
E	5.10	5.45	0.201	0.215
e	1.27 BSC		0.050 BSC	
HE	7.40	8.20	0.291	0.323
L	0.50	0.85	0.020	0.033
LE	1.10	1.50	0.043	0.059
M	0° 10°		0° 10°	
Q ₁	0.70	0.90	0.028	0.035
Z	---	0.78	---	0.031

ON Semiconductor and  are trademarks of Semiconductor Components Industries, LLC (SCILLC). SCILLC reserves the right to make changes without further notice to any products herein. SCILLC makes no warranty, representation or guarantee regarding the suitability of its products for any particular purpose, nor does SCILLC assume any liability arising out of the application or use of any product or circuit, and specifically disclaims any and all liability, including without limitation special, consequential or incidental damages. "Typical" parameters which may be provided in SCILLC data sheets and/or specifications can and do vary in different applications and actual performance may vary over time. All operating parameters, including "Typicals" must be validated for each customer application by customer's technical experts. SCILLC does not convey any license under its patent rights nor the rights of others. SCILLC products are not designed, intended, or authorized for use as components in systems intended for surgical implant into the body, or other applications intended to support or sustain life, or for any other application in which the failure of the SCILLC product could create a situation where personal injury or death may occur. Should Buyer purchase or use SCILLC products for any such unintended or unauthorized application, Buyer shall indemnify and hold SCILLC and its officers, employees, subsidiaries, affiliates, and distributors harmless against all claims, costs, damages, and expenses, and reasonable attorney fees arising out of, directly or indirectly, any claim of personal injury or death associated with such unintended or unauthorized use, even if such claim alleges that SCILLC was negligent regarding the design or manufacture of the part. SCILLC is an Equal Opportunity/Affirmative Action Employer.

PUBLICATION ORDERING INFORMATION

Literature Fulfillment:

Literature Distribution Center for ON Semiconductor
P.O. Box 5163, Denver, Colorado 80217 USA
Phone: 303-675-2175 or 800-344-3860 Toll Free USA/Canada
Fax: 303-675-2176 or 800-344-3867 Toll Free USA/Canada
Email: ONlit@hibbertco.com

N. American Technical Support: 800-282-9855 Toll Free USA/Canada

JAPAN: ON Semiconductor, Japan Customer Focus Center
4-32-1 Nishi-Gotanda, Shinagawa-ku, Tokyo, Japan 141-0031
Phone: 81-3-5740-2700
Email: r14525@onsemi.com

ON Semiconductor Website: <http://onsemi.com>

For additional information, please contact your local Sales Representative.