

# USB 3.1 SuperSpeed 10 Gbps Switch

## FUSB340

### Description

The FUSB340 is a 2:1 data switch for USB SuperSpeed Gen1 and Gen2, 5 Gbps and 10 Gbps data. It is targeted at the mobile device market and for use in Type-C applications where a reversible cable requires a switch.

The FUSB340 data switch offers superior performance various high speed data transmission protocols:

- USB 3.1 SuperSpeed (Gen 2), 10 Gbps
- PCI Express, Gen 3
- SATA
- Fibre Channel
- Display Port 1.3

### Features

- 10 GHz Typical Bandwidth
- USB 3.1 SuperSpeed 5 Gbps and 10 Gbps Switch
- -1.0 dB Typical Insertion Loss at 2.5 GHz
- Low Active Power of 12  $\mu$ A Typical
- Low Shutdown Power of < 1  $\mu$ A Max.
- 2 kV HBM ESD Protection
- Small Packaging, 18 Lead TMLP
- Wide  $V_{DD}$  Operating Range, 1.5 V–5.0 V
- This is a Pb-Free Device

### Applications

- Smartphones
- Tablets
- Notebooks

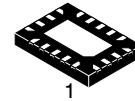

1

**X2QFN18  
CASE 722AB**

### MARKING DIAGRAM

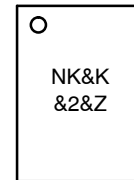

NK = Specific Device Code  
 &K = Lot Code  
 &2 = Date Code  
 &Z = Assembly Plant Code

### ORDERING INFORMATION

See detailed ordering and shipping information on page 6 of this data sheet.

# FUSB340

## BLOCK DIAGRAM

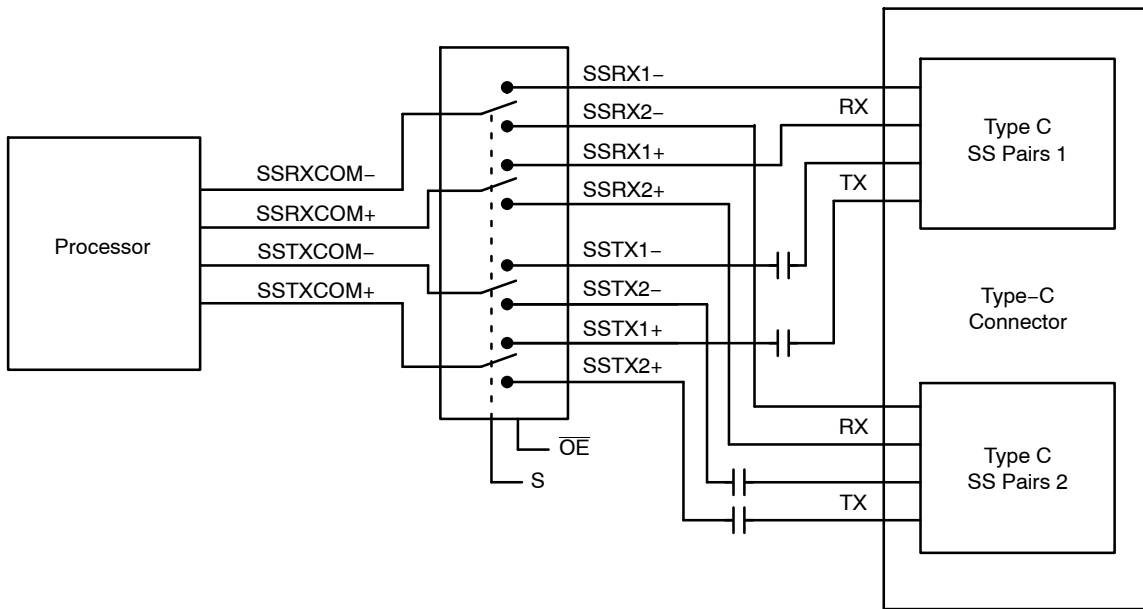

Figure 1. Block Diagram

## TYPICAL APPLICATION

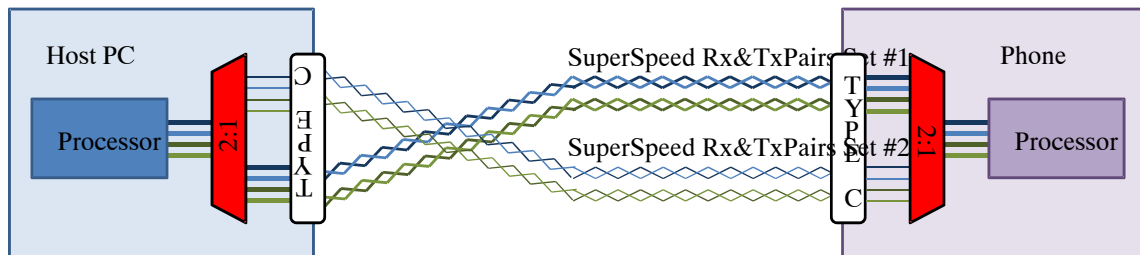

Figure 2. Typical Application

# FUSB340

## PIN CONFIGURATION

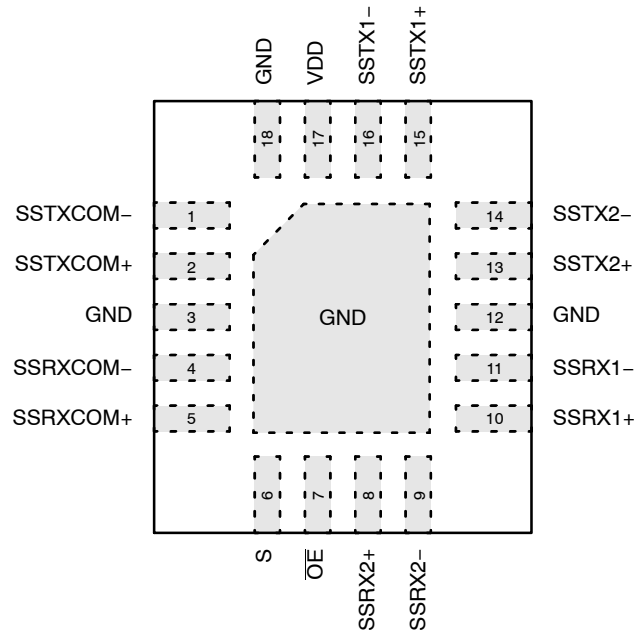

Figure 3. Pin Assignment (Top Through View)

### PIN DESCRIPTIONS

Pin #	Name	Type	Description
1	SSTXCOM-	SW	SuperSpeed TX- Common
2	SSTXCOM+	SW	SuperSpeed TX+ Common
3	GND	GND	Ground (connected to die attach pad)
4	SSRXCOM-	SW	SuperSpeed RX- Common
5	SSRXCOM+	SW	SuperSpeed RX+ Common
6	S	Input	Switch Select (0 = SW1, 1 = SW2)
7	OE	Input	Output Enable (0 = Switches Enabled, 1 = Switches Disabled)
8	SSRX2+	SW	SuperSpeed RX2+
9	SSRX2-	SW	SuperSpeed RX2-
10	SSRX1+	SW	SuperSpeed RX1+
11	SSRX1-	SW	SuperSpeed RX1-
12	GND	GND	Ground (connected to die attach pad)
13	SSTX2+	SW	SuperSpeed TX2+
14	SSTX2-	SW	SuperSpeed TX2-
15	SSTX1+	SW	SuperSpeed TX1+
16	SSTX1-	SW	SuperSpeed TX1-
17	V <sub>DD</sub>	VDD	Device Power
18	GND	GND	Ground

# FUSB340

## ABSOLUTE MAXIMUM RATINGS

Symbol	Parameter	Min	Max	Unit	
V <sub>DD</sub>	Supply Voltage	-0.5	6.0	V	
V <sub>CNTRL</sub>	DC Input Voltage (S, $\overline{OE}$ ) (Note 1)	-0.5	V <sub>DD</sub>	V	
V <sub>SW</sub>	DC Switch I/O Voltage (Notes 1, 2)	-0.3	2.1	V	
I <sub>IK</sub>	DC Input Diode Current	-50	-	mA	
I <sub>sw</sub>	DC Switch Current	-	25	mA	
T <sub>STG</sub>	Storage Temperature	-65	+150	°C	
MSL	Moisture Sensitivity Level (JEDEC J-STD-020A)	-	1		
ESD	Human Body Model, JEDEC: JESD22-A114	All Pins	2	-	kV
	IEC 61000-2-4, Level 4, for Switch Pins	Contact	8	-	
		Air	15	-	
	Charged Device Model, JESD22-C101		1	-	

Stresses exceeding those listed in the Maximum Ratings table may damage the device. If any of these limits are exceeded, device functionality should not be assumed, damage may occur and reliability may be affected.

- The input and output negative ratings may be exceeded if the input and output diode current ratings are observed.
- V<sub>SW</sub> refers to analog data switch paths.

## RECOMMENDED OPERATING RANGES

Symbol	Parameter	Min	Max	Unit
V <sub>DD</sub>	Supply Voltage	1.5	5.0	V
t <sub>RAMP(VDD)</sub>	Power Supply Slew Rate	100	1000	μs/V
V <sub>CNTRL</sub>	Control Input Voltage (S, $\overline{OE}$ ) (Note 3)	0	5.0	V
V <sub>SW</sub>	Switch I/O Voltage (Both SSUSB Switch Paths)	0	2.0	V
T <sub>A</sub>	Operating Temperature	-40	+85	°C

Functional operation above the stresses listed in the Recommended Operating Ranges is not implied. Extended exposure to stresses beyond the Recommended Operating Ranges limits may affect device reliability.

- The control inputs must be held HIGH or LOW; they must not float.

## DC AND TRANSIENT CHARACTERISTICS

All typical values are at T<sub>A</sub> = 25°C unless otherwise specified.

Symbol	Parameter	Conditions	V <sub>DD</sub> (V)	T <sub>A</sub> = -40°C to +85°C			Unit
				Min	Typ	Max	
V <sub>IK</sub>	Clamp Diode Voltage S, $\overline{OE}$	I <sub>IN</sub> = -18 mA	1.5	-1.2	-	-0.6	V
I <sub>IK</sub>	Clamp Diode Current (Switch Pins)	V <sub>IN</sub> = -0.3 V	0	-	-	18	μA
V <sub>IH</sub>	Control Input Voltage High	S, $\overline{OE}$	1.5	1.30	-	-	V
		S, $\overline{OE}$	3.6	1.4	-	-	V
		S, $\overline{OE}$	5.0	1.5	-	-	V
V <sub>IL</sub>	Control Input Voltage Low	S, $\overline{OE}$	1.5	-	-	0.4	V
		S, $\overline{OE}$	3.6	-	-	0.4	V
		S, $\overline{OE}$	5.0	-	-	0.4	V
I <sub>IN</sub>	Control Input Leakage	V <sub>SW</sub> = -0.6 to 2.0 V, V <sub>CNTRL</sub> = 0 to V <sub>DD</sub>	5.0	-500	-	500	nA
I <sub>OZ</sub>	Off-State Leakage for Open Data Paths	V <sub>SW</sub> = 0.0 ≤ DATA ≤ 2.0 V	5.0	-0.5	-	0.5	μA
I <sub>CL</sub>	On-State Leakage for Closed Data Paths (Note 4)	V <sub>SW</sub> = 0.0 ≤ DATA ≤ 2.0 V	5.0	-0.5	-	0.5	μA
I <sub>OFF</sub>	Power-Off Leakage Current (All I/O Ports)	V <sub>SW</sub> = 0 V or 2.0 V	0	-500	-	500	nA

# FUSB340

## DC AND TRANSIENT CHARACTERISTICS (continued)

All typical values are at  $T_A = 25^\circ\text{C}$  unless otherwise specified.

Symbol	Parameter	Conditions	$V_{DD}$ (V)	$T_A = -40^\circ\text{C to } +85^\circ\text{C}$			Unit
				Min	Typ	Max	
$R_{ON}$	Switch On Resistance	$V_{SW} = 0\text{ V}, I_{ON} = -8\text{ mA}$	1.5	–	5.4	8.0	$\Omega$
$\Delta R_{ON}$	Difference in $R_{ON}$ Between Positive–Negative	$V_{SW} = 0\text{ V}, I_{ON} = -8\text{ mA}$	1.5	–	0.1	–	$\Omega$
$R_{ONF}$	Flatness for $R_{ON}$	$V_{SW} = 0 \leq \text{DATA} \leq 2.0\text{ V}, I_{ON} = -8\text{ mA}$	1.5	–	0.9	–	$\Omega$
$I_{CC}$	Quiescent Supply Current	$\overline{V_{OE}} = 0, V_{SEL} = 0\text{ or }V_{DD}, I_{OUT} = 0$	5.0	–	12	30	$\mu\text{A}$
$I_{CCZ}$	Quiescent Supply Current (High Impedance)	$V_{SEL} = X, \overline{V_{OE}} = V_{DD}, I_{OUT} = 0$	5.0	–	–	1	$\mu\text{A}$
$I_{CCT}$	Increase in Quiescent Supply Current per VCNTL	$V_{SEL}$ or $\overline{V_{OE}} = 1.5\text{ V}$	5.0	–	5	15	$\mu\text{A}$

4. For this test, the data switch is closed with the respective switch pin floating.

## AC ELECTRICAL CHARACTERISTICS

All typical value are for  $V_{DD} = 3.6\text{ V}$  and  $T_A = 25^\circ\text{C}$  unless otherwise specified.

Symbol	Parameter	Conditions	$V_{DD}$ (V)	$T_A = -40^\circ\text{C to } +85^\circ\text{C}$			Unit
				Min	Typ	Max	
$t_{ON}$	Turn–On Time, S to Output	$R_L = 50\ \Omega, C_L = 0\text{ pF}, V_{SW} = 0\text{ V}, V_{SW} = 0.6\text{ V}$	1.5 to 5.0 V	–	350	600	ns
$t_{OFF}$	Turn–Off Time, S to Output	$R_L = 50\ \Omega, C_L = 0\text{ pF}, V_{SW} = 0\text{ V}, V_{SW} = 0.6\text{ V}$	1.5 to 5.0 V	–	125	300	ns
$t_{ZHM,ZL}$	Enable Time, $\overline{OE}$ to Output	$R_L = 50\ \Omega, C_L = 0\text{ pF}, V_{SW} = 0.6\text{ V}$	1.5 to 5.0 V	–	60	150	$\mu\text{s}$
$t_{LZM,HZ}$	Disable Time, $\overline{OE}$ to Output	$R_L = 50\ \Omega, C_L = 0\text{ pF}, V_{SW} = 0.6\text{ V}$	1.5 to 5.0 V	–	35	240	ns
$t_{PD}$	Propagation Delay (Note 5)	$C_L = 0\text{ pF}, R_L = 50\ \Omega$	1.5 to 5.0 V	–	60	–	ps
$t_{BBM}$	Break–Before–Make (Note 5)	$R_L = 50\ \Omega, C_L = 0\text{ pF}, V_{SW1} = 0.6\text{ V}, V_{SW2} = -0.6\text{ V}$	1.5 to 5.0 V	100	–	350	ns
$DO_{IRR}$	Differential Off Isolation (Note 5)	$V_S = 0\text{ dBm}, R_L = 50\ \Omega, f = 2.5\text{ GHz}$	3.6 V	–	–28	–	dB
		$V_S = 0\text{ dBm}, R_L = 50\ \Omega, f = 5.0\text{ GHz}$			–25		
SDDNEXT	Differential Channel Crosstalk (Note 5)	$V_S = 0\text{ dBm}, R = 50\ \Omega, f = 2.5\text{ GHz}$	3.6 V	–	–44	–	dB
		$V_S = 0\text{ dBm}, R = 50\ \Omega, f = 5.0\text{ GHz}$			–40		
DIL	Differential Insertion Loss (Note 5) (All Data Paths)	$V_{IN} = 0\text{ dBm}, f = 2.5\text{ GHz}, R_L = 50\ \Omega, C_L = 0\text{ pF}$	3.6 V	–	–1.0	–	dB
		$V_{IN} = 0\text{ dBm}, f = 5.0\text{ GHz}, R_L = 50\ \Omega, C_L = 0\text{ pF}$			–1.8		
BW	Differential, –3 dB Bandwidth (Note 5)	$V_{IN} = 1\text{ Vpk-pk}, R_L = 50\ \Omega, C_L = 0\text{ pF}$ (Both Data Paths)	3.6 V	–	10	–	GHz
$t_{SK(P)}$	Skew of Opposite Transitions of the Same Output (Note 5)	$R_{PU} = 50\ \Omega\text{ to }V_{DD}, C_L = 0\text{ pF}$	3.6 V	–	6	–	ps
$C_{IN}$	Control Pin Input Capacitance (Note 5)	$V_{DD} = 0\text{ V}, f = 1\text{ MHz}$		–	2.7	–	pF
$C_{ON}$	On Capacitance (Note 5)	$V_{DD} = 3.3\text{ V}, f = 2.5\text{ GHz}$		–	0.5	–	pF
$C_{OFF}$	Off Capacitance (Note 5)	$V_{DD} = 3.3\text{ V}, f = 2.5\text{ GHz}$		–	0.4	–	pF

Product parametric performance is indicated in the Electrical Characteristics for the listed test conditions, unless otherwise noted. Product performance may not be indicated by the Electrical Characteristics if operated under different conditions.

5. Guaranteed by characterization.

# FUSB340

## EYE DIAGRAMS

(All plots below are for  $V_{DD} = 3.6\text{ V}$  and  $T_A = 25^\circ\text{C}$  with 0 dBm differential data.)

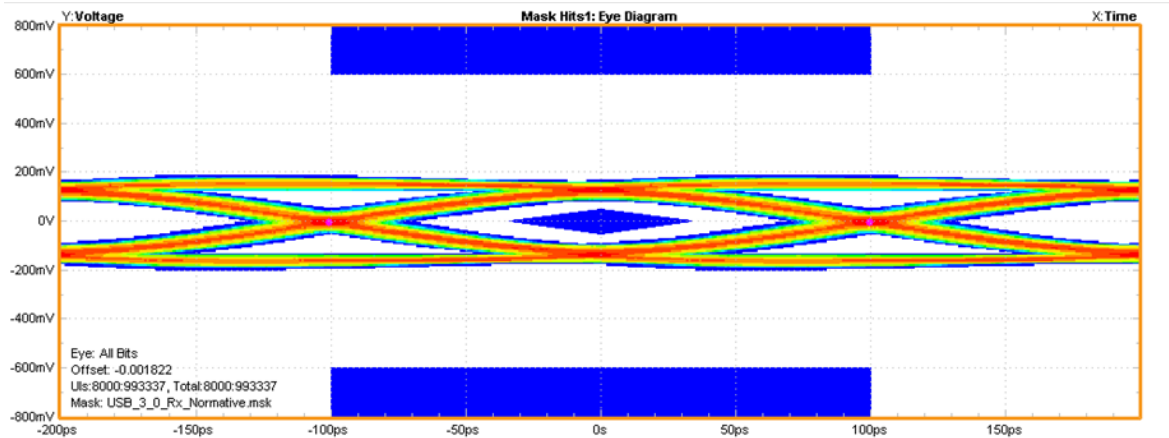

Figure 4. 5 Gbps Eye Diagram with Eye Mask

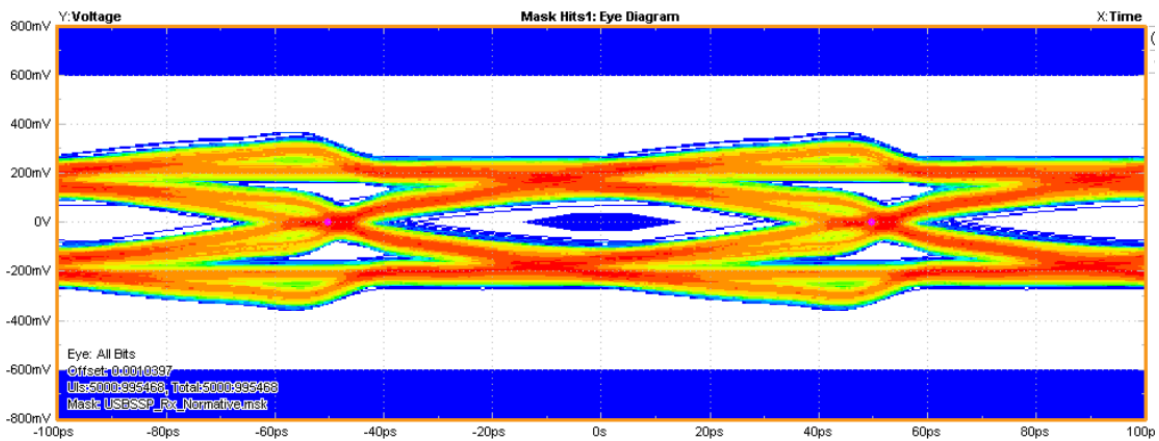

Figure 5. 10 Gbps Eye Diagram with Eye Mask

### ORDERING INFORMATION

Part Number	Operating Temperature Range	Package	Shipping <sup>†</sup>
FUSB340TMX	-40 to +85°C	18-Lead, Quad, Ultra-ultrathin Molded Leadless Package (TMLP), 2.0 mm × 2.8 mm × 0.375 mm	5,000 / Tape & Reel

<sup>†</sup>For information on tape and reel specifications, including part orientation and tape sizes, please refer to our Tape and Reel Packaging Specifications Brochure, BRD8011/D.

The table below pertains to the UMLP Package drawing on the following page.

### PRODUCT-SPECIFIC DIMENSIONS

Product	A	B
FUSB340TMX	2.00 mm	2.80 mm

# MECHANICAL CASE OUTLINE

## PACKAGE DIMENSIONS

ON Semiconductor®

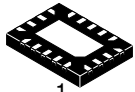

SCALE 4:1

**X2QFN18, 2.0x2.8, 0.4P**  
CASE 722AB  
ISSUE O

DATE 17 MAY 2016

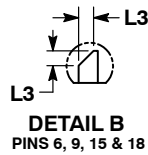
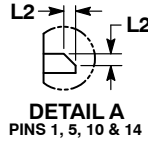
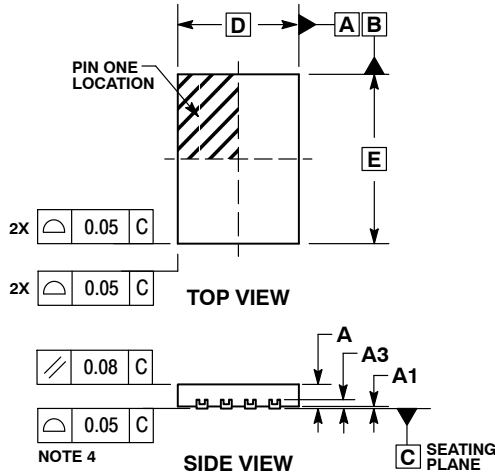

**NOTES:**

1. DIMENSIONING AND TOLERANCING PER ASME Y14.5M, 1994.
2. CONTROLLING DIMENSION: MILLIMETERS
3. DIMENSION b APPLIES TO PLATED TERMINAL AND IS MEASURED BETWEEN 0.15 AND 0.25 MM FROM THE TERMINAL TIP.
4. COPLANARITY APPLIES TO THE EXPOSED PAD AS WELL AS THE TERMINALS.

DIM	MILLIMETERS	
	MIN	MAX
A	---	0.40
A1	0.00	0.05
A3	0.13 REF	
b	0.13	0.23
D	2.00 BSC	
D2	0.90	1.00
E	2.80 BSC	
E2	1.70	1.80
e	0.40 BSC	
L	0.25	0.35
L2	0.11 REF	
L3	0.14 REF	

**GENERIC MARKING DIAGRAM\***

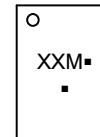

- XX = Specific Device Code
- M = Month Code
- = Pb-Free Package

(Note: Microdot may be in either location)

\*This information is generic. Please refer to device data sheet for actual part marking. Pb-Free indicator, "G", may or not be present.

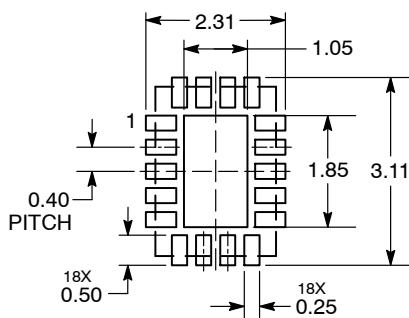
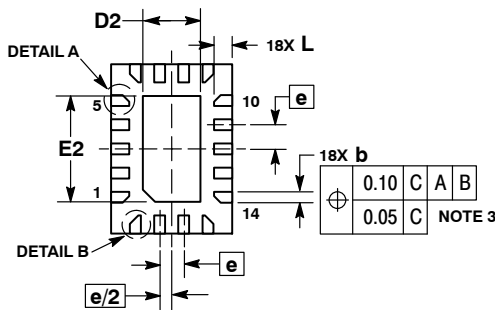

\*For additional information on our Pb-Free strategy and soldering details, please download the ON Semiconductor Soldering and Mounting Techniques Reference Manual, SOLDERRM/D.

<b>DOCUMENT NUMBER:</b>	<b>98AON11641G</b>	Electronic versions are uncontrolled except when accessed directly from the Document Repository. Printed versions are uncontrolled except when stamped "CONTROLLED COPY" in red.
<b>DESCRIPTION:</b>	<b>X2QFN18, 2.0 X 2.8, 0.4P</b>	<b>PAGE 1 OF 1</b>

ON Semiconductor and ON are trademarks of Semiconductor Components Industries, LLC dba ON Semiconductor or its subsidiaries in the United States and/or other countries. ON Semiconductor reserves the right to make changes without further notice to any products herein. ON Semiconductor makes no warranty, representation or guarantee regarding the suitability of its products for any particular purpose, nor does ON Semiconductor assume any liability arising out of the application or use of any product or circuit, and specifically disclaims any and all liability, including without limitation special, consequential or incidental damages. ON Semiconductor does not convey any license under its patent rights nor the rights of others.

**onsemi**, **Onsemi**, and other names, marks, and brands are registered and/or common law trademarks of Semiconductor Components Industries, LLC dba "**onsemi**" or its affiliates and/or subsidiaries in the United States and/or other countries. **onsemi** owns the rights to a number of patents, trademarks, copyrights, trade secrets, and other intellectual property. A listing of **onsemi**'s product/patent coverage may be accessed at [www.onsemi.com/site/pdf/Patent-Marking.pdf](http://www.onsemi.com/site/pdf/Patent-Marking.pdf). **onsemi** reserves the right to make changes at any time to any products or information herein, without notice. The information herein is provided "as-is" and **onsemi** makes no warranty, representation or guarantee regarding the accuracy of the information, product features, availability, functionality, or suitability of its products for any particular purpose, nor does **onsemi** assume any liability arising out of the application or use of any product or circuit, and specifically disclaims any and all liability, including without limitation special, consequential or incidental damages. Buyer is responsible for its products and applications using **onsemi** products, including compliance with all laws, regulations and safety requirements or standards, regardless of any support or applications information provided by **onsemi**. "Typical" parameters which may be provided in **onsemi** data sheets and/or specifications can and do vary in different applications and actual performance may vary over time. All operating parameters, including "Typicals" must be validated for each customer application by customer's technical experts. **onsemi** does not convey any license under any of its intellectual property rights nor the rights of others. **onsemi** products are not designed, intended, or authorized for use as a critical component in life support systems or any FDA Class 3 medical devices or medical devices with a same or similar classification in a foreign jurisdiction or any devices intended for implantation in the human body. Should Buyer purchase or use **onsemi** products for any such unintended or unauthorized application, Buyer shall indemnify and hold **onsemi** and its officers, employees, subsidiaries, affiliates, and distributors harmless against all claims, costs, damages, and expenses, and reasonable attorney fees arising out of, directly or indirectly, any claim of personal injury or death associated with such unintended or unauthorized use, even if such claim alleges that **onsemi** was negligent regarding the design or manufacture of the part. **onsemi** is an Equal Opportunity/Affirmative Action Employer. This literature is subject to all applicable copyright laws and is not for resale in any manner.

## PUBLICATION ORDERING INFORMATION

### LITERATURE FULFILLMENT:

Email Requests to: [orderlit@onsemi.com](mailto:orderlit@onsemi.com)

**onsemi Website:** [www.onsemi.com](http://www.onsemi.com)

### TECHNICAL SUPPORT

**North American Technical Support:**

Voice Mail: 1 800-282-9855 Toll Free USA/Canada

Phone: 011 421 33 790 2910

**Europe, Middle East and Africa Technical Support:**

Phone: 00421 33 790 2910

For additional information, please contact your local Sales Representative