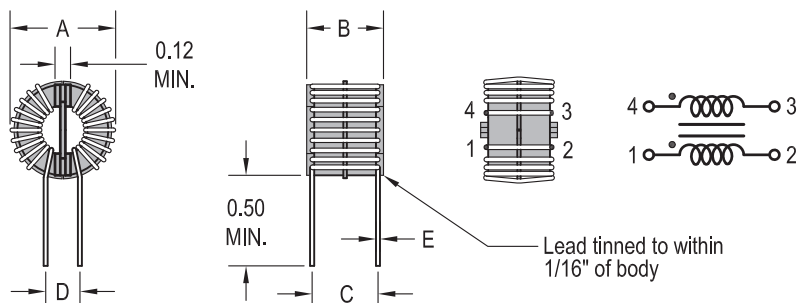

VCM710

Common Mode Choke

**Features**

- Wide Range of Values and Current Ratings
- Excellent EMI Suppression
- Cross to Miller / Bourns 7100 series
- Core encased in UL94V-0 housing

Electrical

Inductance Range: .51mH to 42.5mH
Tolerance: Inductance shown in min. L
Test Frequency: 1KHz
Operating Temp: -55°C ~ 105°C
Temp Rise: Idc based on a 35°C temp rise Typ.
Dielectric Strength: 3750Vrms
Base: VW-1 Flamability Rating

Physical

Packaging: In box Trays
Marking: None

Allied Part Number	L(mH) Min @ 1KHZ	IDC (A)	DCR (mΩ) Max.	Dim A Max Inch	Dim B Max Inch	Dim C Nom Inch	Dim D Nom Inch	Dim E Max Inch
VCM7101-RC	0.51	1.0	0.040	0.700	0.450	0.400	0.200	0.016
VCM7102-RC	0.85	1.0	0.060	0.700	0.450	0.400	0.200	0.016
VCM7103-RC	1.70	1.0	0.070	0.700	0.450	0.400	0.200	0.016
VCM7104-RC	2.55	1.0	0.100	0.700	0.450	0.400	0.200	0.016
VCM7105-RC	4.25	1.0	0.125	0.700	0.450	0.400	0.200	0.016
VCM7106-RC	0.51	2.0	0.030	0.700	0.450	0.400	0.200	0.020
VCM7107-RC	0.85	2.0	0.040	0.700	0.450	0.400	0.200	0.020
VCM7108-RC	1.70	2.0	0.060	0.700	0.450	0.400	0.200	0.020
VCM7109-RC	2.55	2.0	0.075	0.600	0.450	0.400	0.200	0.020
VCM7110-RC	0.51	3.0	0.020	0.600	0.450	0.400	0.200	0.023
VCM7111-RC	0.85	3.0	0.030	0.600	0.450	0.400	0.200	0.023
VCM7112-RC	0.85	2.0	0.050	0.800	0.550	0.500	0.300	0.023
VCM7113-RC	1.70	2.0	0.075	0.800	0.550	0.500	0.300	0.023
VCM7114-RC	2.55	2.0	0.085	0.800	0.550	0.500	0.300	0.023
VCM7115-RC	4.25	2.0	0.110	0.800	0.550	0.500	0.300	0.023
VCM7116-RC	6.80	2.0	0.200	0.800	0.550	0.500	0.300	0.023
VCM7117-RC	0.85	5.0	0.035	0.800	0.550	0.500	0.300	0.030
VCM7118-RC	1.70	5.0	0.040	1.20	0.800	0.700	0.400	0.030
VCM7119-RC	4.25	4.0	0.046	1.20	0.800	0.700	0.400	0.030
VCM7120-RC	6.80	4.0	0.060	1.20	0.800	0.700	0.400	0.030
VCM7121-RC	42.5	2.0	0.200	1.20	0.800	0.700	0.400	0.023
VCM7122-RC	25.5	4.0	0.130	1.20	0.800	0.700	0.400	0.030
VCM7123-RC	9.35	5.0	0.072	1.20	0.800	0.700	0.400	0.036
VCM7124-RC	2.55	10	0.020	1.20	0.800	0.700	0.400	0.046

All specifications subject to change without notice.