

ECMS1V0905

Common mode choke, surface mount



Product features

- High frequency filter
- Square type closed magnetic core
- Current rating up to 6 A
- 10 mm x 7.5 mm surface mount package in a 4.8 mm height
- Moisture sensitivity level (MSL): 1

Applications

- Battery backup
- Renewable energy products
- High tech consumer products
- Appliances
- LED lighting
- Smart meters
- Industrial IoT equipment
- Motion controls
- Power supplies
- Medical equipment

Environmental compliance and general specifications

- Storage temperature (component): -40 °C to +125 °C
- Operating temperature range: -40 °C to +125 °C (ambient plus self-temperature rise)
- Solder reflow temperature: J-STD-020 (latest revision) compliant



Product specifications

Part number ⁵	Impedance ¹ (Ω) minimum	Impedance ¹ (Ω) typical	DCR ² (mΩ) @ +25 °C maximum	Rated current ³ (A) maximum	Rated voltage (Vdc) maximum	Insulation resistance ⁴ @ (MΩ) minimum
ECMS1V0905-301-R	225	300	6.0	6.0	80	10
ECMS1V0905-601-R	450	600	8.0	5.5	80	10
ECMS1V0905-701-R	500	700	10	5.0	80	10
ECMS1V0905-102-R	750	1000	13	4.0	80	10
ECMS1V0905-222-R	1700	2200	50	3.0	80	10
ECMS1V0905-272-R	2000	2700	80	2.0	80	10

1. Impedance test parameters: 100 MHz, 0.1 Vrms, parallel connection (1,2 - 4,3), +25 °C
2. DCR test parameters: parallel connection (1,2 - 4,3), 4-wire method measured at +25°C
3. Rated current: DC current for an approximate temperature rise of 40 °C without core loss. It is recommended that the temperature of the part not exceed +125 °C under worst case operating conditions verified in the end application.

4. Insulation resistance: Coil to coil
5. Part Number Definition: ECMS1Vxxx-yyy-R
 ECMS1V = Product code
 xxx = Size indicator
 yyy = Typical impedance value in ohms. R= decimal point, if no R is present then last digit indicates the number of zeros
 -R suffix = RoHS compliant

Mechanical parameters, schematic, pad layout (mm)

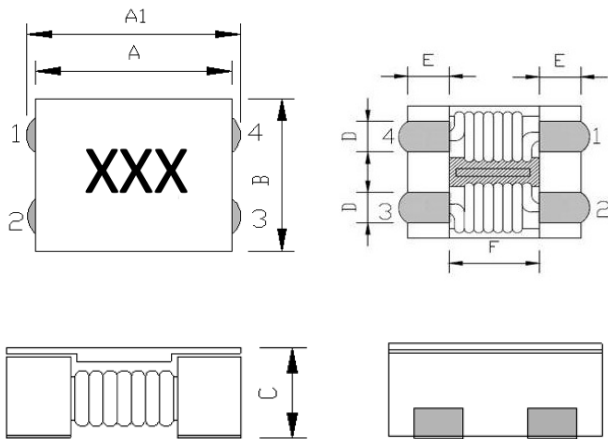

Dimension	Value
A	9.0 ±0.5
A1	9.5 ±0.5
B	7.0 ±0.5
C	4.8 maximum
D	1.5 typical
E	1.7 typical
F	5.6 typical

Part marking: xxx= Typical impedance value in ohms
 All soldering surfaces to be coplanar within 0.1 millimeters
 Tolerances are ±0.5 millimeters unless stated otherwise
 Traces or vias underneath the inductor is not recommended

Recommended PCB Layout

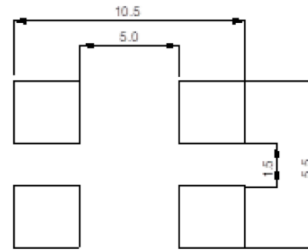

Schematic

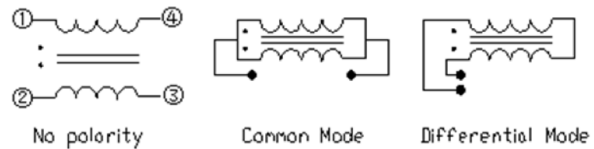

Packaging information (mm)

Supplied in tape and reel packaging, 13" diameter reel (EIA-481 compliant)
700 parts per reel

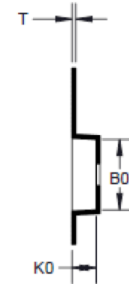
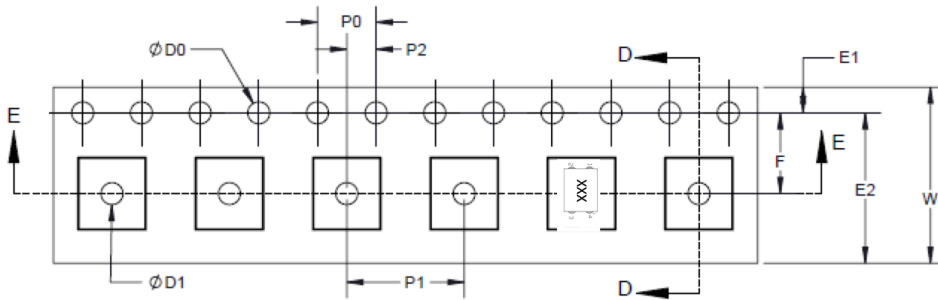

SECTION D-D

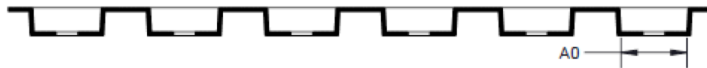

SECTION E-E

Dimension	Value
W	24.0 ±0.3
F	11.5 ±0.1
E1	1.75 ±0.1
E2	na
P0	4.0 ±0.1
P1	16 ±0.1
P2	2.0 ±0.1
D0	1.5 +0.1/-0
D1	1.5 +0.1/-0
A0	9.5 ±0.1
B0	7.7 ±0.1
K0	5.0 ±0.1
T	0.4 ±0.05

Impedance vs frequency

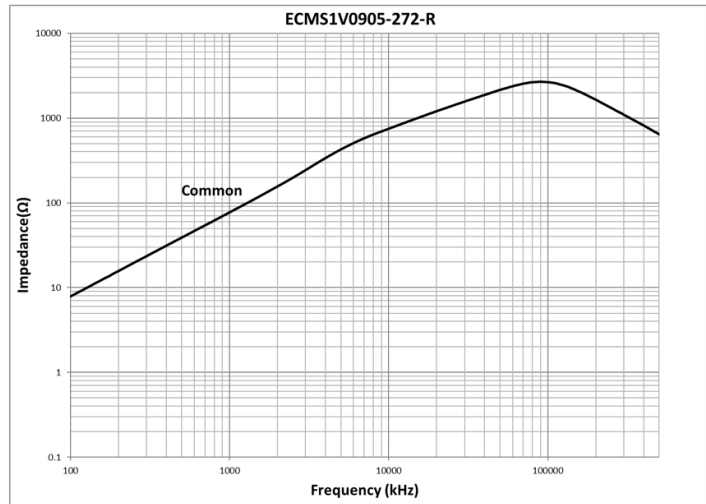
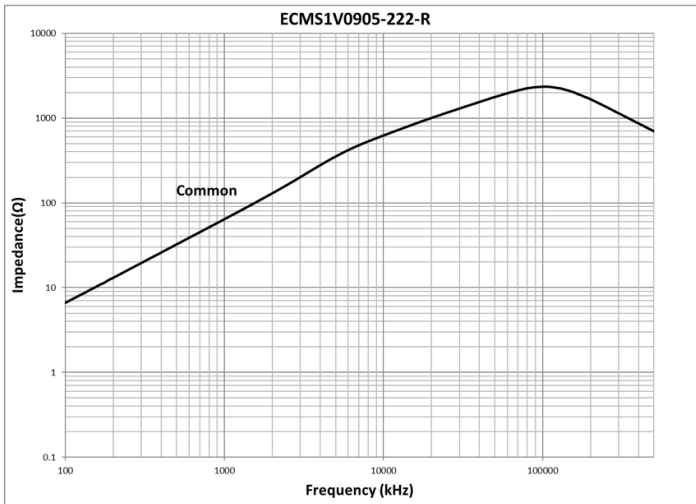
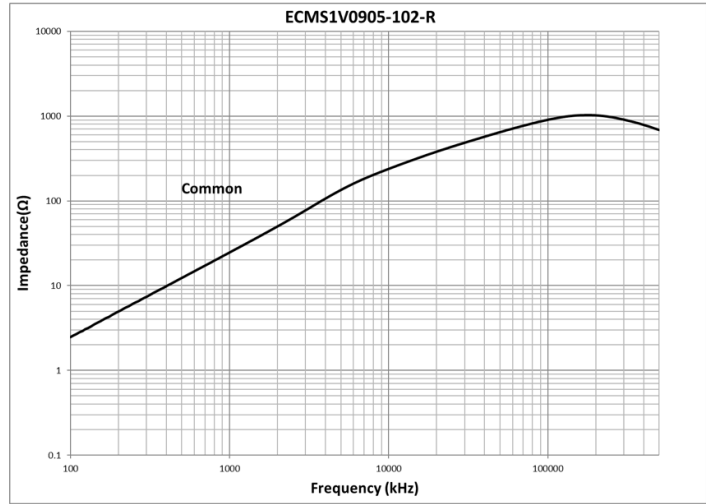
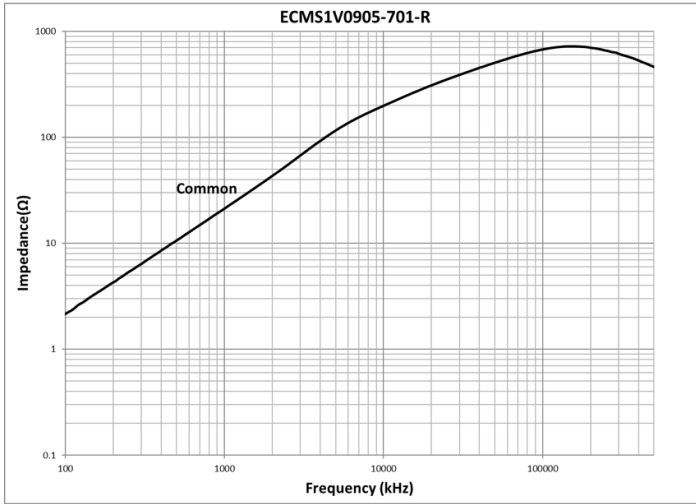
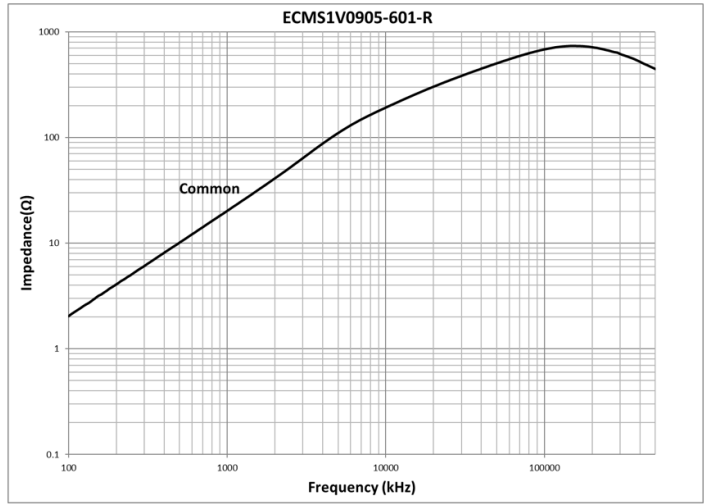
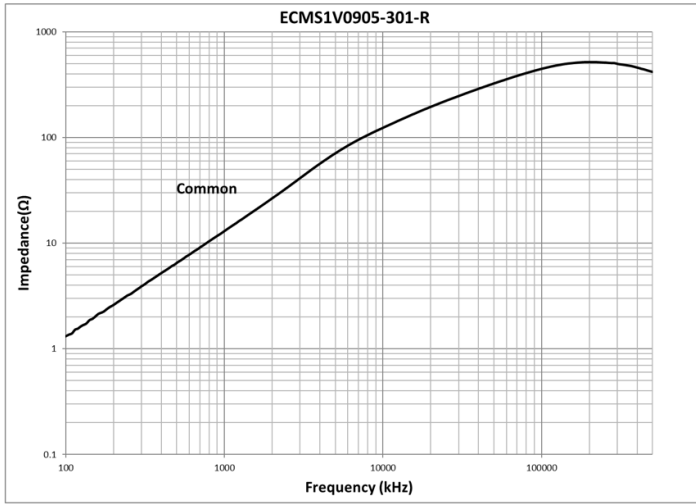

Solder reflow profile

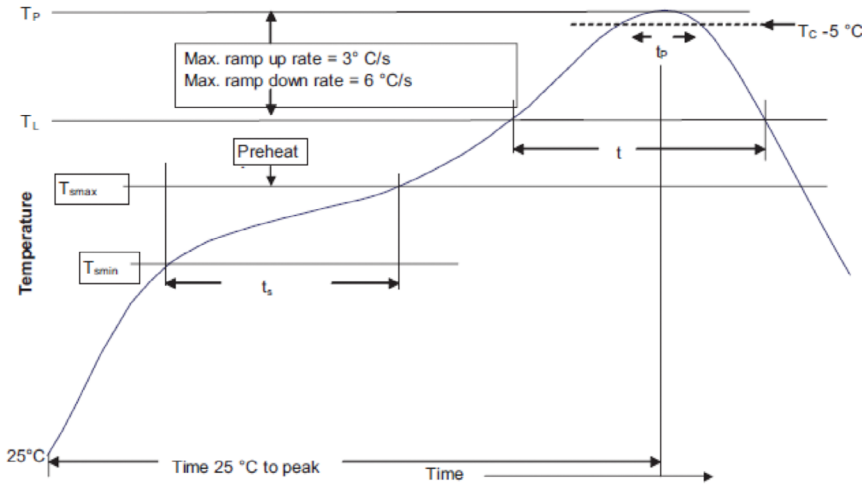

Table 1 - Standard SnPb solder (T_C)

Package Thickness	Volume mm ³ <350	Volume mm ³ ≥350
<2.5 mm)	235 °C	220 °C
≥2.5 mm	220 °C	220 °C

Table 2 - Lead (Pb) free solder (T_C)

Package thickness	Volume mm ³ <350	Volume mm ³ 350 - 2000	Volume mm ³ >2000
<1.6 mm	260 °C	260 °C	260 °C
1.6 – 2.5 mm	260 °C	250 °C	245 °C
>2.5 mm	250 °C	245 °C	245 °C

Reference J-STD-020

Profile feature	Standard SnPb solder	Lead (Pb) free solder
Preheat and soak		
• Temperature min. (T _{smin})	100 °C	150 °C
• Temperature max. (T _{smax})	150 °C	200 °C
• Time (T _{smin} to T _{smax}) (t _s)	60-120 seconds	60-120 seconds
Ramp up rate T _L to T _p	3 °C/ second max.	3 °C/ second max.
Liquidous temperature (T _L)	183 °C	217 °C
Time (t _L) maintained above T _L	60-150 seconds	60-150 seconds
Peak package body temperature (T _p)*	Table 1	Table 2
Time (t _p)* within 5 °C of the specified classification temperature (T _C)	20 seconds*	30 seconds*
Ramp-down rate (T _p to T _L)	6 °C/ second max.	6 °C/ second max.
Time 25 °C to peak temperature	6 minutes max.	8 minutes max.

* Tolerance for peak profile temperature (T_p) is defined as a supplier minimum and a user maximum.

Life Support Policy: Eaton does not authorize the use of any of its products for use in life support devices or systems without the express written approval of an officer of the Company. Life support systems are devices which support or sustain life, and whose failure to perform, when properly used in accordance with instructions for use provided in the labeling, can be reasonably expected to result in significant injury to the user.

Eaton reserves the right, without notice, to change design or construction of any products and to discontinue or limit distribution of any products. Eaton also reserves the right to change or update, without notice, any technical information contained in this bulletin.

Eaton
Electronics Division
1000 Eaton Boulevard
Cleveland, OH 44122
United States
Eaton.com/electronics

© 2021 Eaton
All Rights Reserved
Printed in USA
Publication No. ELX1113 BU-ELX21125
December 2021

Eaton is a registered trademark.
All other trademarks are property of their respective owners.

Follow us on social media to get the latest product and support information.

