

COMMON MODE CHOKES

960046A

- Designed to reduce EMI and filter common mode noise
- Multiple signal lines and packaging options available
- Custom designs available
- Operational frequencies from 100KHz to over 500MHz
- 500 Vrms minimum isolation
- Application note available describing how to reduce affects of common mode noise and to effectively implement common mode chokes

ELECTRICALS AT 25°C

Part No.	No. of Signal Lines (1)	OCL Lp (µH) Min	Common Mode Attenuation (dB) Typical								DCR (ohms) Max	Schematic	Package Style
			300KHz	1MHz	10MHz	30MHz	50MHz	100MHz	300MHz	500MHz			
0553-3965-00	2x1	80	-13	-21	-28	-28	-26	-24	-18	-12	0.10	J	11
0553-3965-08	2x1	140	-15	-25	-40	-45	-43	-36	-22	-20	0.80	J	11
0553-3965-09	2x1	140	-15	-25	-40	-45	-43	-36	-22	-20	0.80	J	11
0553-5841-01	2x2	140	-15	-25	-40	-45	-43	-36	-22	-20	0.50	A	1
0555-3001-08	2x2	120	-16	-26	-38	-44	-42	-38	-18	-16	0.80	E	1
0555-5999-04	4x1	35	-5	-12	-26	-31	-32	-29	-13	-12	0.50	D	2
0555-5999-13	2x1	140	-15	-25	-40	-45	-43	-36	-22	-20	0.50	J	11
0555-5999-16	2x1	18	-7	-15	-28	-31	-30	-24	-12	-6	0.16	J	11
A555-0139-01	2x2	80	-15	-22	-37	-42	-39	-32	-18	-12	0.30	E	5
A555-1006-AF	2x4	80	-12	-21	-30	-29	-28	-25	-18	-10	0.25	B	4
A555-3536-01	4x1	18	-5	-10	-24	-29	-31	-29	-14	-11	0.25	D	5
A555-5999-20	4x2	68	-9	-15	-26	-28	-28	-27	-18	-10	0.20	K	4
A555-5999-21	4x1	68	-9	-15	-26	-28	-28	-27	-18	-10	0.20	D	5
A555-5999-25	4x1	24	-6	-16	-28	-32	-34	-31	-20	-12	0.35	D	5
S555-0139-01	2x2	80	-15	-22	-37	-42	-39	-32	-18	-12	0.30	E	3
S555-0379-00	4x1	68	-12	-20	-29	-28	-27	-25	-18	-11	0.30	D	6
S555-2940-00	2x3	80	-12	-19	-26	-27	-27	-25	-18	-10	0.20	I	9
S555-5999-02	2x2	140	-15	-25	-40	-45	-43	-36	-22	-20	0.80	E	7
S555-5999-03	4x1	30	-6	-16	-28	-32	-34	-31	-20	-12	0.50	D	3
S555-5999-04	2x1	86	-13	-20	-28	-27	-26	-23	-12	-5	0.15	H	8
S555-5999-09	2x2	86	-12	-20	-29	-28	-27	-25	-18	-11	0.15	C	9
S555-5999-15	2x2	38	-4	-9	-22	-28	-30	-28	-12	-12	0.50	E	12
S555-5999-22	4x2	36	-9	-15	-26	-28	-28	-27	-18	-10	0.35	B	9
S555-5999-23	2x1	36	-7	-15	-28	-31	-30	-24	-12	-6	0.35	H	8
S555-5999-26	2x2	30	-4	-9	-22	-28	-30	-28	-12	-12	0.50	G	9
S555-5999-27	2x1	42	-7	-15	-28	-31	-30	-24	-12	-6	0.35	F	7
S555-5999-28	2x2	140	-15	-25	-40	-45	-43	-36	-22	-20	0.80	C	10
S558-5999-08	2x2	110	-8	-19	-32	-36	-37	-35	-23	-13	0.80	C	9

1. Number of wires on choke multiplied by the number of chokes in the package.

Specifications subject to change without notice.

COMMON MODE CHOKES

960046A

SCHEMATICS

A

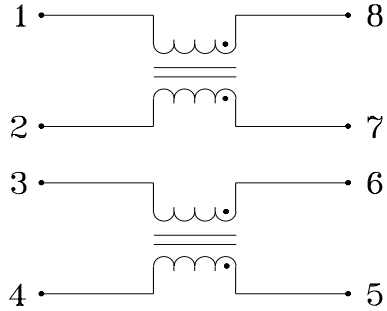

B

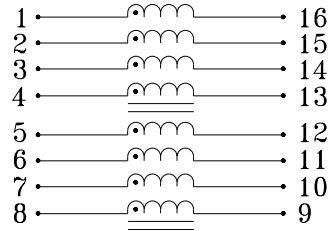

C

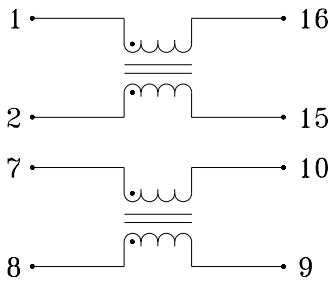

D

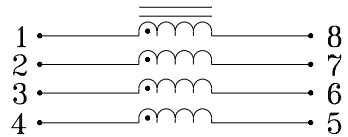

E

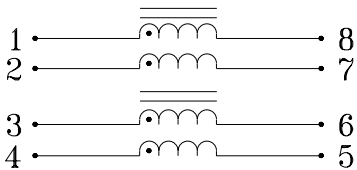

F

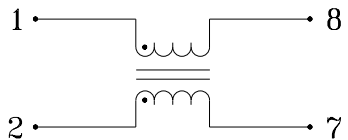

Specifications subject to change without notice.

COMMON MODE CHOKES

SCHEMATICS (CONT'D)

G

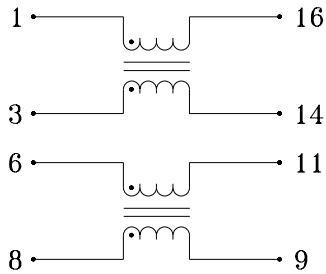

H

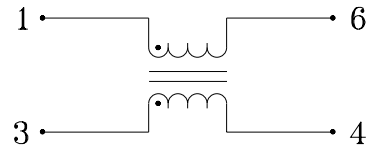

I

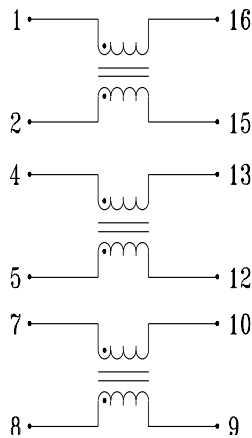

J

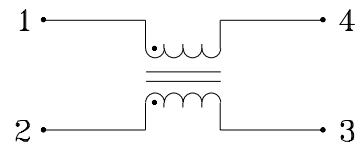

K

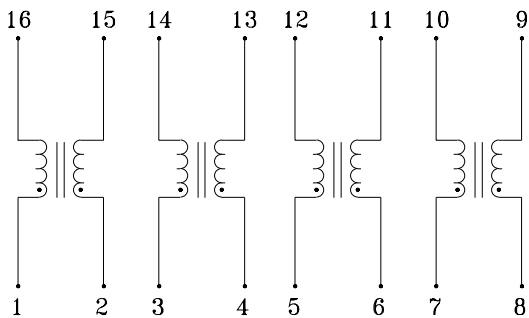

COMMON MODE CHOKES

960046A

MECHANICALS

1

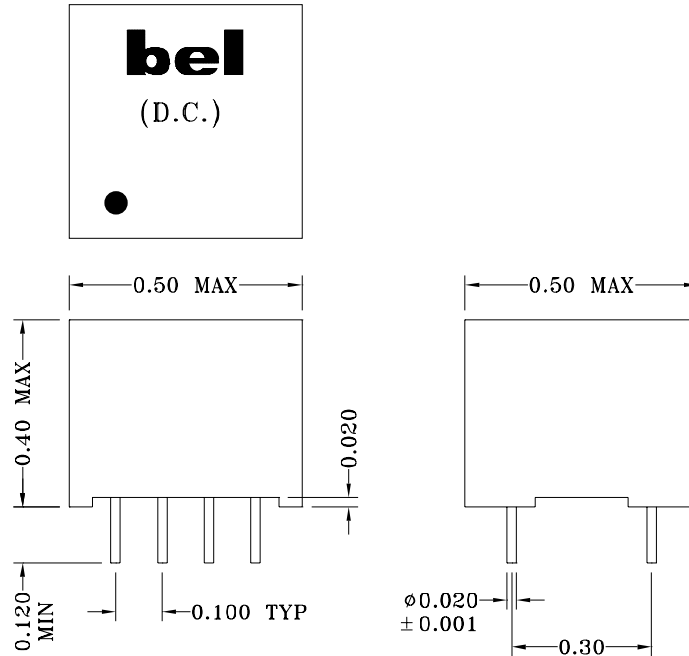

2

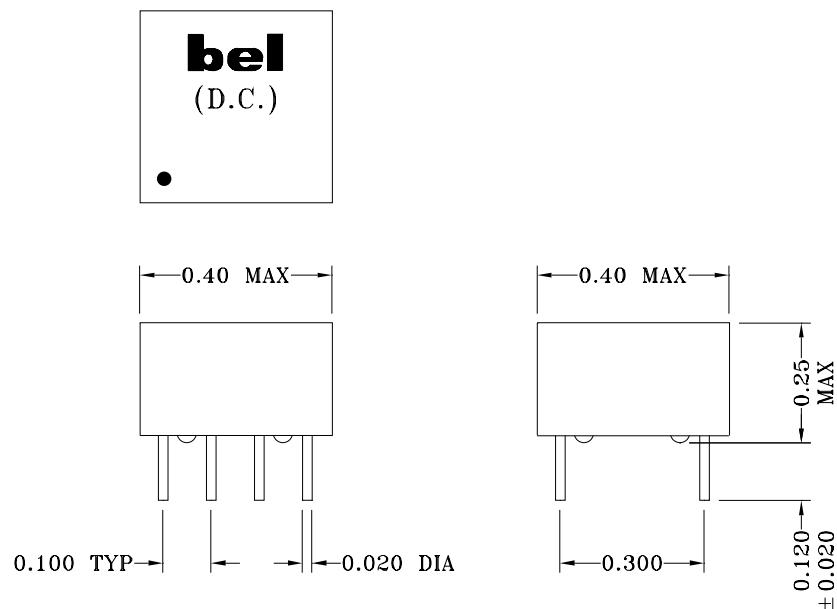

Specifications subject to change without notice.

COMMON MODE CHOKES

MECHANICALS (CONT'D)

3

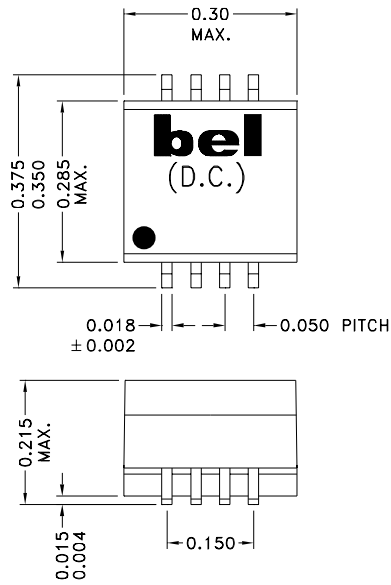

RECOMMEND PCB PAD LAYOUT

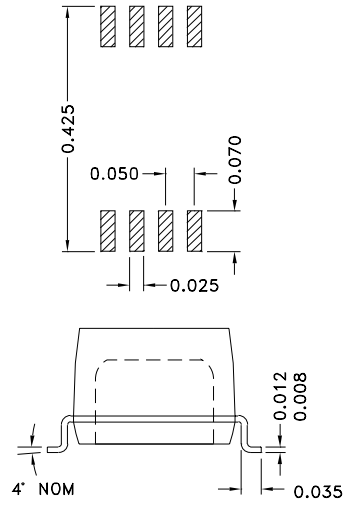

4

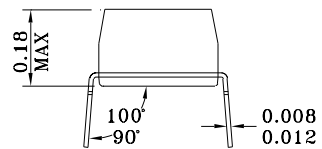
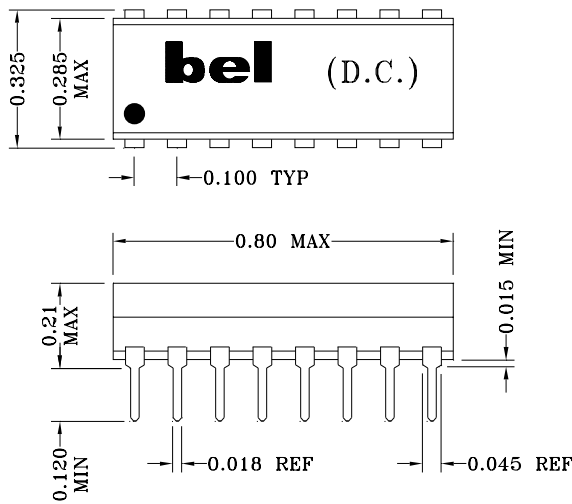

Specifications subject to change without notice.

COMMON MODE CHOKES

960046A

MECHANICALS (CONT'D)

5

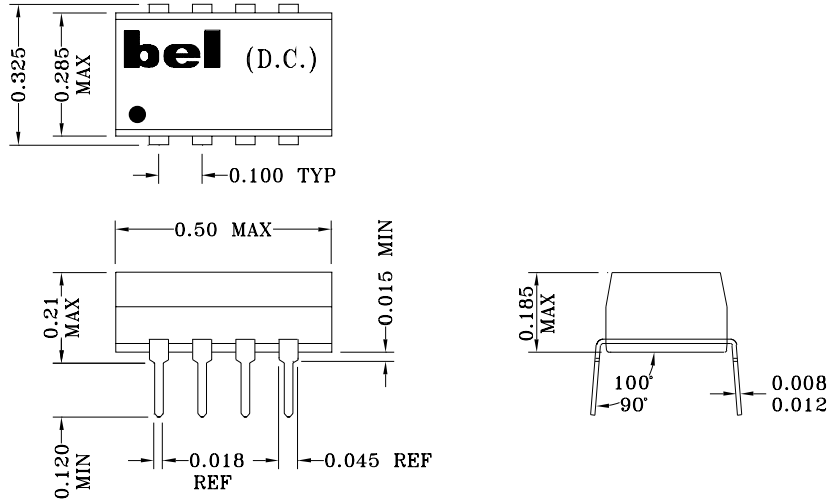

6

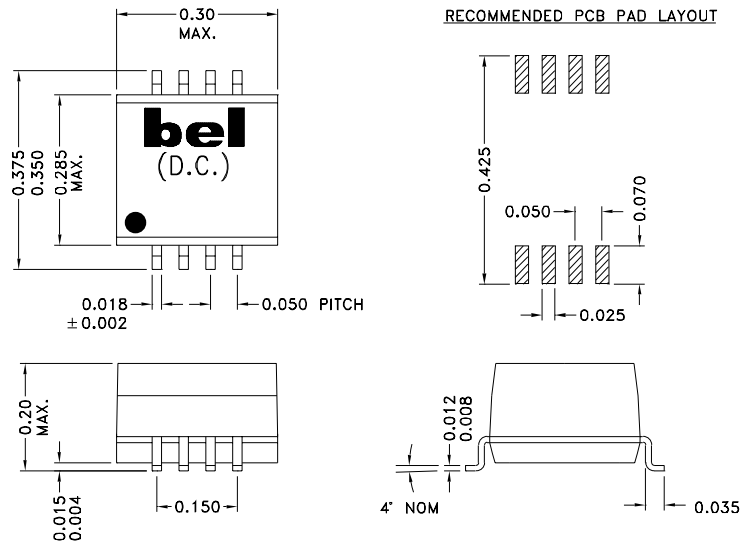

Specifications subject to change without notice.

COMMON MODE CHOKES

MECHANICALS (CONT'D)

7

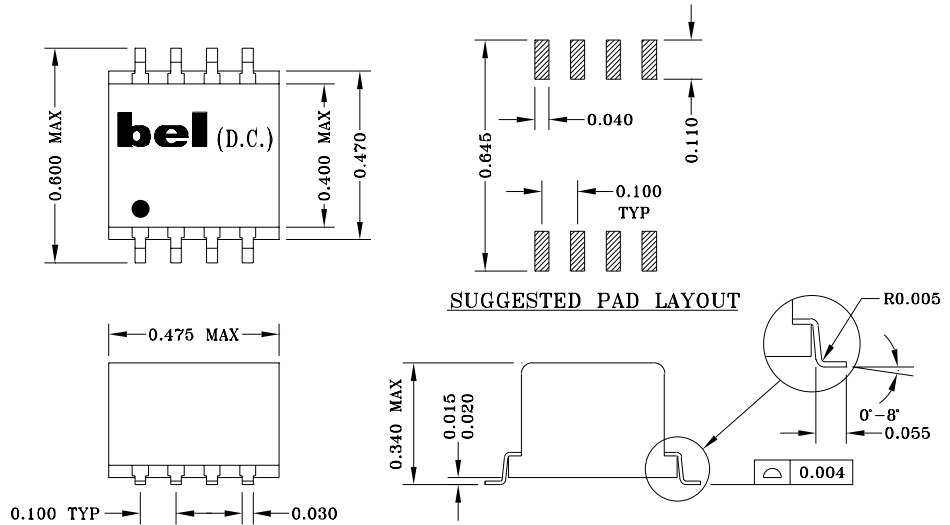

8

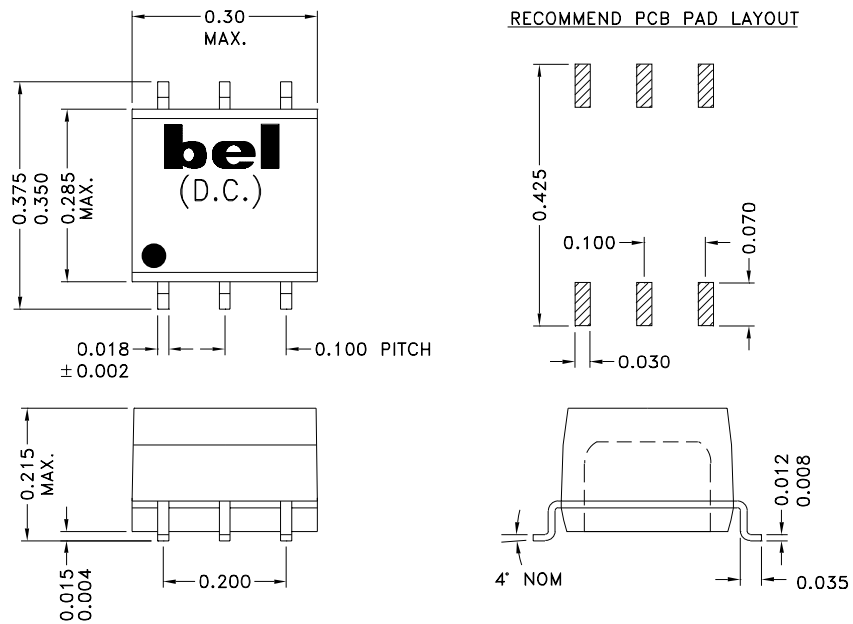

Specifications subject to change without notice.

COMMON MODE CHOKES

960046A

MECHANICALS (CONT'D)

9

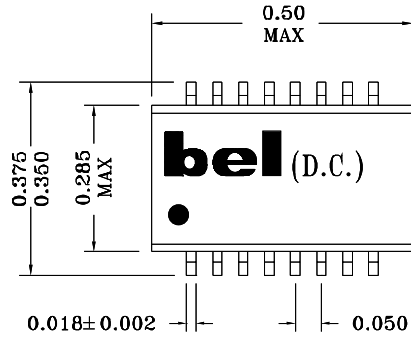

SUGGESTED PCB PAD LAYOUT

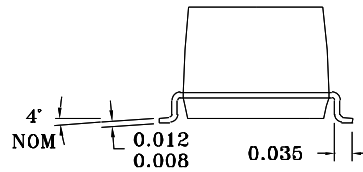
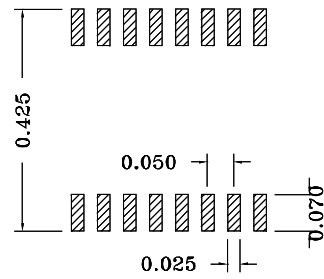

10

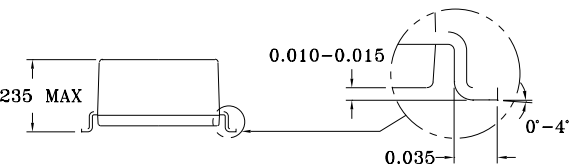
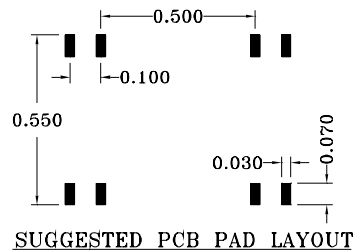
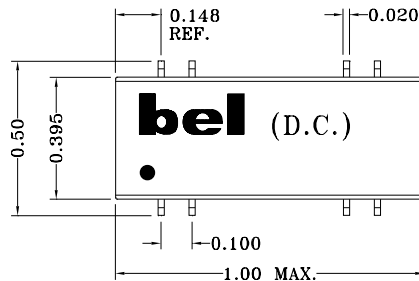

Specifications subject to change without notice.

COMMON MODE CHOKES

MECHANICALS (CONT'D)

11

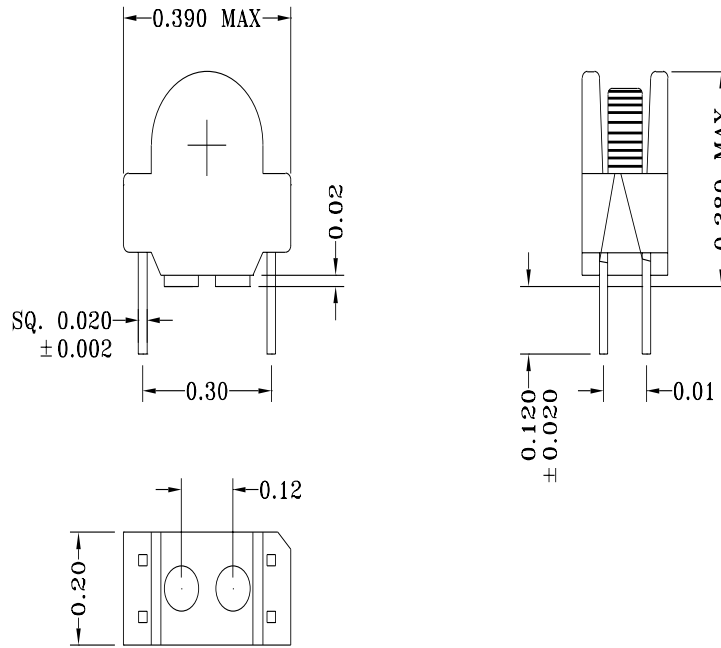

12

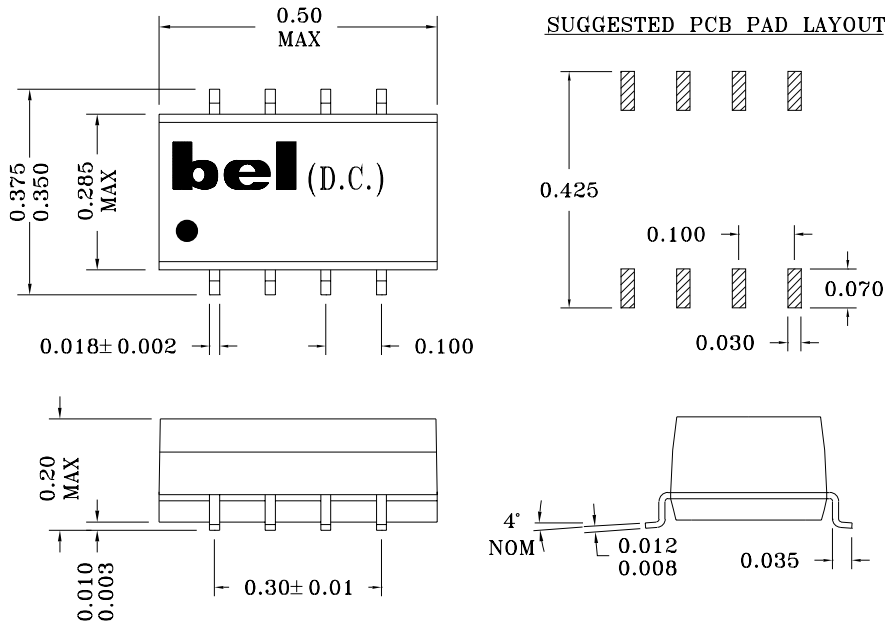

Specifications subject to change without notice.

COMMON MODE CHOKES

960046A

APPLICATION CIRCUIT

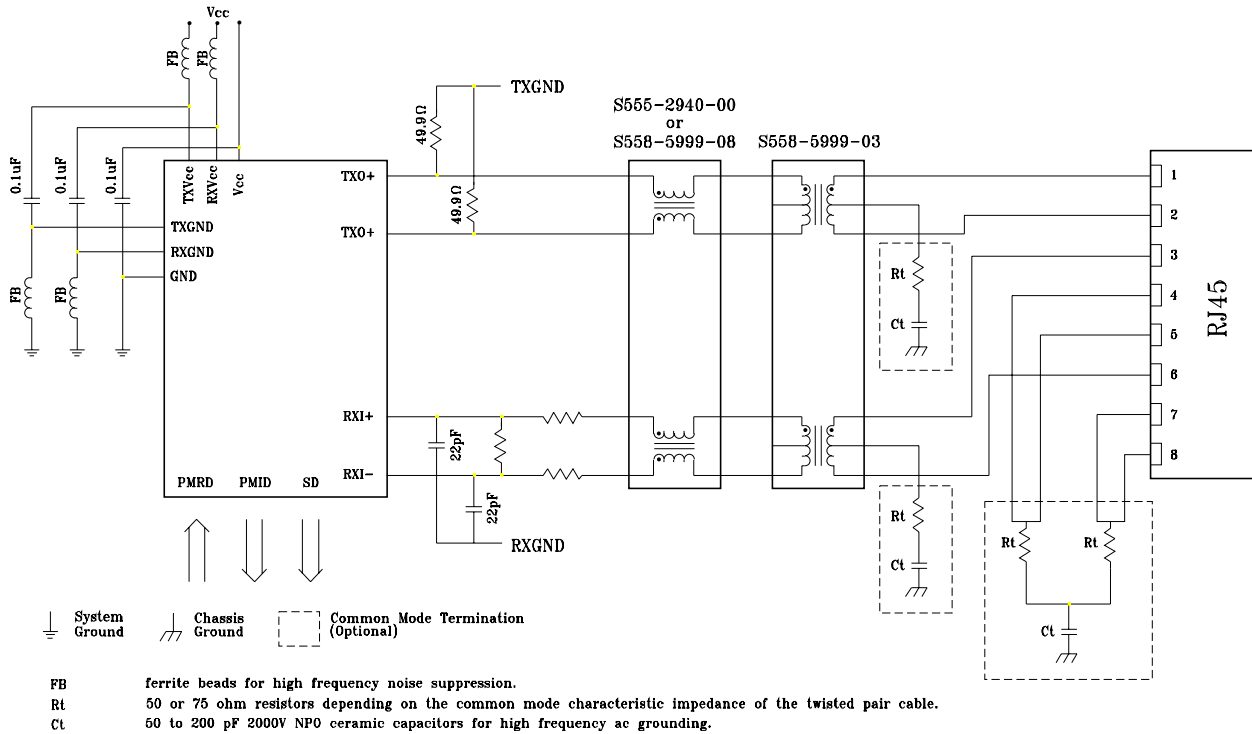

Common Mode Test Circuit

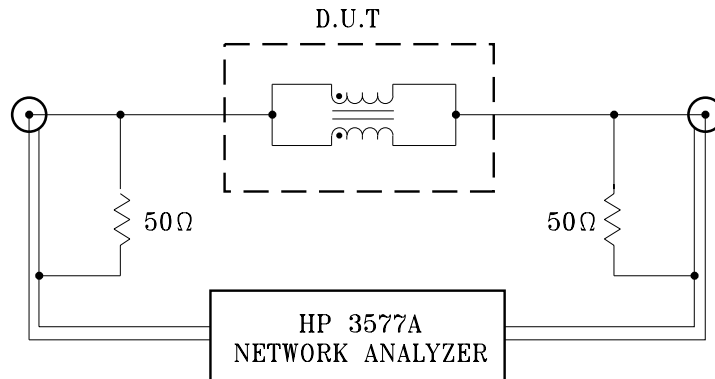

Corporate Office

Bel Fuse Inc.
 198 Van Vorst Street, Jersey City, NJ 07302-4496
 Tel: 201-432-0463
 Fax: 201-432-9542
 E-Mail: BelFuse@belfuse.com
 Internet: <http://www.belfuse.com>

Far East Office

Bel Fuse Ltd.
 8F/8 Luk Hop Street
 San Po Kong
 Kowloon, Hong Kong
 Tel: 852-2328-5515
 Fax: 852-2352-3706

European Office

Bel Fuse Europe Ltd.
 Preston Technology Management Centre
 Marsh Lane, Preston PR1 8UD
 Lancashire, U.K.
 Tel: 44-1772-556601
 Fax: 44-1772-888366