



## Specifications for UHF Connectors

UHF style connectors are inexpensive, general purpose connectors with non-constant impedance for use at 500 volts or less, and for use with low frequencies to 200Mhz for best performance, or to 500MHz but with diminished performance. These coaxial connectors are widely used in citizens band communications, CCTV, public address systems, mobile radio equipment, civil defense, ship to shore communications, antenna connections, landing systems, and ground control apparatus. UHF connectors use a 5/8-24 threaded coupling. They are available in a wide selection of sizes to fit various cable sizes.

S

MATERIALS	
Connector Parts	Material
Connector Body and Parts	Brass
Male Contact Pin	Brass
Outer Contact	Brass
Crimp Ferrule	Annealed Copper
Insulators,	Delrin, Teflon
Plating	Nickel

ELECTRICAL	
Requirement	Performance
Impedance	Non Constant
Frequency Range	0-500MHz
VSWR	1.25 Max.
Working Voltage (At Sea level)	750V rms
Insulation Resistance	5000 Megohm Min.
Contact Resistance	5mW Max.
Test Voltage	2000V rms

MECHANICAL & ENVIRONMENTAL	
Requirement	Performance
Durability	500 Matings
Cable Retention (Cable Types)	RG58 - 60 Lb. Min.
	RG59 - 75 Lb. Min.
	RG8, 213 - 150 Lb. Min.
Coupling Nut	45 lbs. Maximum
Temperature Range	Delrin: -55 to +85°C
	Teflon: -55 to +200°C

S

## UHF Connectors

### Crimp Plugs

UHF cable plugs are available in two-piece crimp and older versions. Several cable diameters are facilitated with these connectors for applicable applications. A reducing adapter is used for smaller cable sizes when using the solder types.

Part Number	RoHS	Description	RG/U Cable	Fig. No.
710A205F	<input checked="" type="checkbox"/>	Crimp Plug	58	106
710A205G	<input checked="" type="checkbox"/>	Crimp Plug	59, 62	106
710A908B	<input checked="" type="checkbox"/>	Twist/Solder Plug, PL259	8, 213	107
770A508F	<input checked="" type="checkbox"/>	Reducing Adapter, UG175/U	58	108
770A508G	<input checked="" type="checkbox"/>	Reducing Adapter, UG176/U	58	108

RoHS compliant [REQUEST QUOTE](#) [REQUEST DRAWING](#)

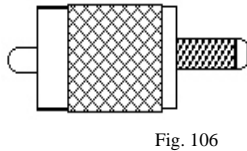

Fig. 106

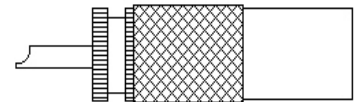

Fig. 107

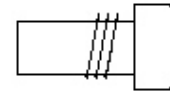

Fig. 108

### Jacks

Two panel jack style are available as standard items. These panel jacks will facilitate any cable size by soldering the center conductor to the connector's solder-cup contact.

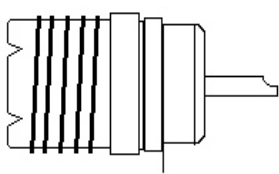

Fig. 109

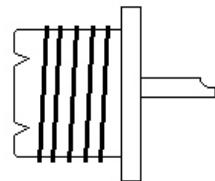
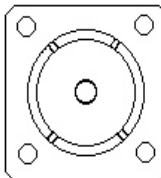

Fig. 110



Part Number	RoHS	Description	RG/U Cable	Fig. No.
726A508	<input checked="" type="checkbox"/>	Bulkhead Jack	Any	109
727A508	<input checked="" type="checkbox"/>	Panel Jack, SO239 Type	Any	110

RoHS compliant [REQUEST QUOTE](#) [REQUEST DRAWING](#)

### Adapters

Standard configurations of adapters are machined brass with attractive nickel plating. All contacts are gold plated brass (males) and phosphor bronze (females).

Part Number	RoHS	Description	Fig. No.
731A505	<input checked="" type="checkbox"/>	Male/Male	111

732A508	<input checked="" type="checkbox"/>	Female/Female Inline	112
735A504	<input checked="" type="checkbox"/>	Female/Female, Bulkhead	113
743A508	<input checked="" type="checkbox"/>	F/M/F "T" Adapter	114
745A508	<input checked="" type="checkbox"/>	F/F/F "T" Adapter	115
751A505	<input checked="" type="checkbox"/>	F/M Right Angle Adapter	116

RoHS compliant    [REQUEST QUOTE](#)    [REQUEST DRAWING](#)

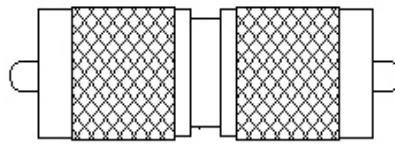

Fig. 111

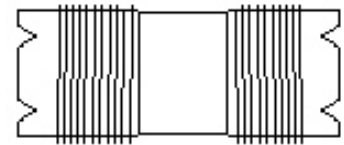

Fig. 112

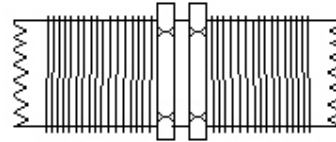

Fig. 113

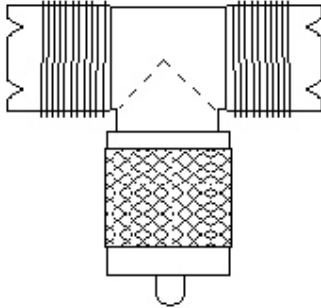

Fig. 114

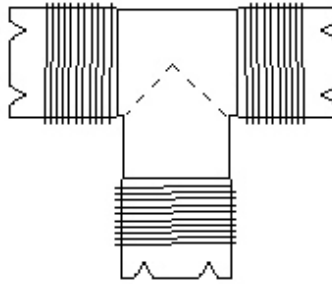

Fig. 115

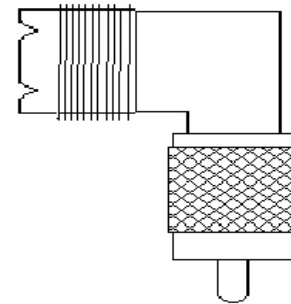

Fig. 116

S