

# CGS64/74B304 Octal Divide-by-2 Skew Clock Driver

## General Description

These minimum skew clock drivers are designed for high frequency Clock Generation & Support (CGS) applications. These devices are ideal for duty cycle recovery applications with internal frequency divide-by-2 circuitry. The devices guarantee minimum skew across the outputs of a given device. Skew parameters are also provided as a means to measure duty cycle requirements as those found in high speed clocking systems.

## Functional Description

The CGS64/74B304 contains eight flip-flops designed to have low skew between outputs. The eight outputs (eight in-phase with CLK) toggle on successive CLK pulses.

PRE and CLR inputs are provided to set Q and  $\bar{Q}$  outputs high or low independent of CLK pin.

## Features

- Clock Generation & Support (CGS) devices ideal for high frequency signal generation or clock distribution applications
- Fabricated on National's Advanced Bipolar FAST™ LSI process
- 900 ps pin-to-pin output skew
- Specification for transition skew to meet duty cycle requirements
- Current sourcing 24 mA and current sinking of 48 mA
- Low dynamic power consumption above 20 MHz
- Guaranteed 4 kV ESD protection

## Ordering Code: See Section 5

## Connection Diagrams

**Pin Assignment for DIP (N) and SOIC (M)**

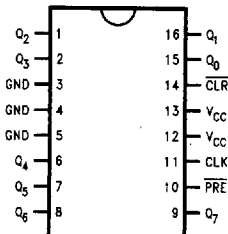

TL/F/11750-1

**Pin Assignment 28-Pin PLCC (V)**

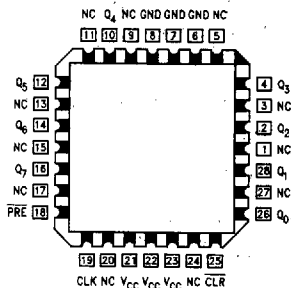

TL/F/11750-2

## Pin Description

Pin Names	Description
CLK	Clock Input
Q <sub>0</sub> -Q <sub>7</sub>	Outputs
PRE	Preset
CLR	Clear

## Logic Diagram

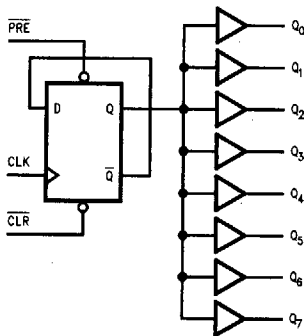

TL/F/11750-3

## Truth Table

Inputs			Outputs
CLR	PRE	CLK	Q <sub>0</sub> -Q <sub>7</sub>
L	H	X	L
H	L	X	H
L	L	X	L*
H	H	↑	$\bar{Q}_0$
H	H	L	Q <sub>0</sub>

\*This state will not persist when CLR/PRE returns to high.

**Absolute Maximum Ratings** (Note)

If Military/Aerospace specified devices are required, please contact the National Semiconductor Sales Office/Distributors for availability and specifications.

Supply Voltage ( $V_{CC}$ )		7.0V
Input Voltage ( $V_i$ )		7.0V
Operating Free	74B304	0°C to +70°C
Air Temperature	64B304	-40°C to +85°C
Storage Temperature Range		-65°C to +150°C

Typical  $\theta_{JA}$ 

Airflow (LFM)	0	225	500	°C/W
Plastic (N) Package	95	70	60	°C/W
Jedec SOIC (M) Package	118	96	86	°C/W
PLCC (V) Package	69	53	45	°C/W

**Recommended Operating Conditions**

Supply Voltage ( $V_{CC}$ )	4.5V to 5.5V
Input Rise and Fall Times (0.8V to 2.0V)	2 ns max
Free Air Operating Temperature ( $T_A$ )	0 to 70°C

NOTE: The Absolute Maximum Ratings are those values beyond which the safety of the device cannot be guaranteed. The device should not be operated at these limits. The parametric values defined in the DC and AC Electrical Characteristics tables are not guaranteed at the absolute maximum ratings. The Recommended Operating Conditions will define the conditions for actual device operation.

**DC Electrical Characteristics CGS64/74B304**

Over recommended operating conditions unless specified otherwise. All typical values are measured at  $V_{CC} = 5V$ ,  $T_A = 25^\circ C$

Symbol	Parameter	Conditions	Min	Typ	Max	Units
$V_{IK}$	Input Clamp Voltage	$V_{CC} = 4.5V$ , $I_I = -18 mA$			-1.2	V
$V_{IH}$	Minimum Input High Level Voltage		2.0			V
$V_{IL}$	Maximum Input Low Level Voltage				0.8	V
$V_{OH}$	High Level Output Voltage	$I_{OH} = -2 mA$ , $V_{CC} = 4.5V$	$V_{CC} - 2$			V
		$I_{OH} = 24 mA$ , $V_{CC} = 4.5V$	2.0			
$V_{OL}$	Low Level Output Voltage	$V_{CC} = 4.5V$ , $I_{OL} = 48 mA$		0.35	0.5	V
$I_I$	Input Current @ Max Input Voltage	$V_{CC} = 5.5V$ , $V_{IH} = 7V$			0.1	mA
$I_{IH}$	High Level Input Current	$V_{CC} = 5.5V$ , $V_{IH} = 2.7V$			20	$\mu A$
$I_{IL}$	Low Level Input Current	$V_{CC} = 5.5V$ , $V_{IL} = 0.4V$		-0.1	-0.50	mA
$I_O$	Output Drive Current	$V_{CC} = 5.5V$ , $V_O = 2.25V$	-50		-150	mA
$I_{CC}$	Supply Current	$V_{CC} = 5.5V$	Outputs High	20	30	mA
			Outputs Low	42	55	mA
$C_{IN}$	Input Capacitance	$V_{CC} = 5V$		5		pF

## AC Electrical Characteristics

Over recommended operating conditions unless specified otherwise. All typical values are measured at  $V_{CC} = 5V$ ,  $T_A = 25^\circ C$

Symbol	Parameter	CGS74B304			CGS64B304			Units
		$V_{CC} = 4.5V \text{ to } 5.5V$ $T_A = 0^\circ C \text{ to } +70^\circ C$ $C_L = 0 \text{ pF} - 50 \text{ pF}$ $R_L = 500\Omega$			$V_{CC} = 4.5V \text{ to } 5.5V$ $T_A = -40^\circ C \text{ to } +85^\circ C$ $C_L = 0 \text{ pF} - 50 \text{ pF}$ $R_L = 500\Omega$			
		Min	Typ	Max	Min	Typ	Max	
$f_{MAX}$	Maximum Input Frequency (Note 2)	110			100			MHz
$t_{PLH}$ , $t_{PHL}$	Propagation Delay CLKn to O <sub>n</sub> (Note 2)	4		8.5	4		8.5	ns
$t_{PLH}$ , $t_{PHL}$	Propagation Delay PRE/CLR (Note 2)	4		11	4		11	ns
$t_{SU}$	Set Up Time before CLK	5			5			ns
$t_W$	CLK HI	4			4			ns
	CLK LO	4			4			
	CLR/PRE	4			4			

## Extended AC Electrical Characteristics

Over recommended operating conditions unless specified otherwise. All typical values are measured at  $V_{CC} = 5V$ ,  $T_A = 25^\circ C$

Symbol	Parameter	CGS74B304			CGS64B304			Units
		$V_{CC} = 4.5V \text{ to } 5.5V$ $T_A = 0^\circ C \text{ to } +70^\circ C$ $C_L = 0 \text{ pF} - 50 \text{ pF}$ $R_L = 500\Omega$			$V_{CC} = 4.5V \text{ to } 5.5V$ $T_A = -40^\circ C \text{ to } +85^\circ C$ $C_L = 0 \text{ pF} - 50 \text{ pF}$ $R_L = 500\Omega$			
		Min	Typ	Max	Min	Typ	Max	
$t_{OSLH Q}$	Maximum Skew Common Edge Output-to-Output Variation (Notes 1, 2)		0.5	0.9		0.5	0.9	ns
$t_{OSLH Q}$	Maximum Skew Common Edge Output-to-Output Variation (Notes 1, 2)		0.5	0.9		0.5	0.9	ns
$t_{PS}$	Maximum Skew. Pin (Signal) Transition Variation (Note 1)	PDIP		1.1			1.1	ns
		SOIC		1.1			1.1	
		PLCC		1.3			1.3	
$t_{rise}$ , $t_{fall}$	Rise/Fall Time (from 0.8V/2.0V to 2.0V/0.8V) 0 pF–30 pF Loads (Note 2)		1.1 0.9	2.0 2.0		1.1 0.9	2.0 2.0	ns

**Note 1:** Output-to-Output Skew is defined as the absolute value of the difference between the actual propagation delay for any outputs within the same packaged device. The specifications apply to any outputs switching in the same direction either HIGH to LOW ( $t_{OSHL}$ ) or LOW to HIGH ( $t_{OSLH}$ ) or in opposite directions both HL and LH ( $t_{OST}$ ). Parameters  $t_{OST}$  and  $t_{PS}$  guaranteed by design.

**Note 2:** This device is sensitive to noise due to the large transient currents which occur during multiple switching of the outputs.  $V_{CC}$  bypass capacitor(s), chip types, must be placed as closely as possible to the  $V_{CC}$  pin.

**Note 3:** Refer to Minimum Skew Parameters Measurement Information Chart for definitions of each skew specification.

**Note 4:** All input pulses are from 3.5V to 0.3V with rise and fall times of 2.0 ns.

**Note 5:** Load capacitance includes the test jig.

# Timing Diagrams

## Minimum Skew Divide-by-2 Clock Drivers CGS64/74B304

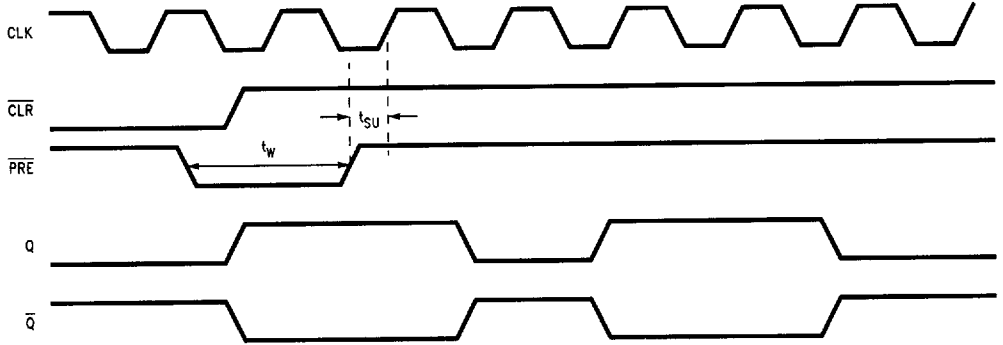

TL/F/11750-4

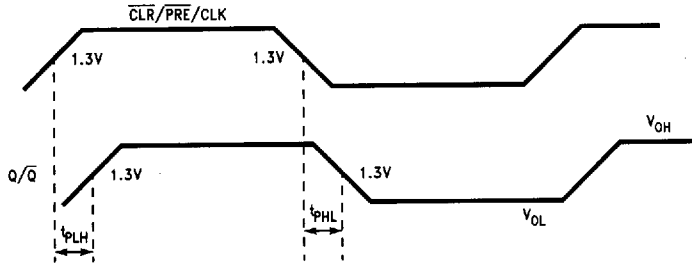

TL/F/11750-5

## Test Circuit

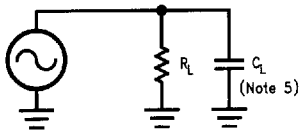

TL/F/11750-6

$R_L$  is 500 $\Omega$   
 $C_L$  is 50 pF for all prop delays and skew measurements.  
 $C_L$  is 30 pF for  $t_{rise}$  and  $t_{fall}$  measurements.

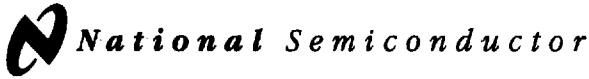

### 8 Lead (0.150" Wide) Molded Small Outline Package, JEDEC NS Package Number M08A

All dimensions are in inches (millimeters)

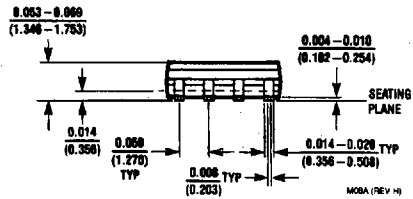
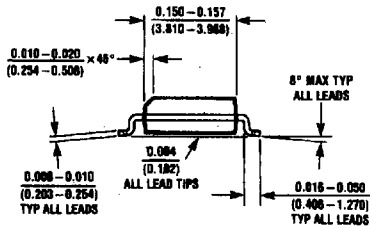
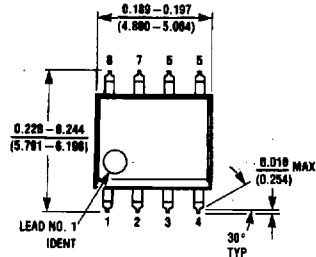

M08A (REV H)

### 14 Lead (0.150" Wide) Molded Small Outline Package, JEDEC NS Package Number M14A

All dimensions are in inches (millimeters)

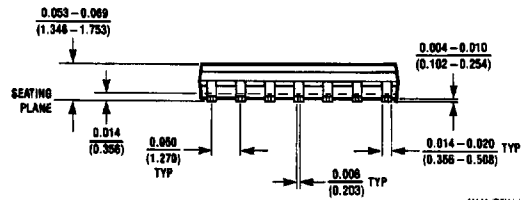
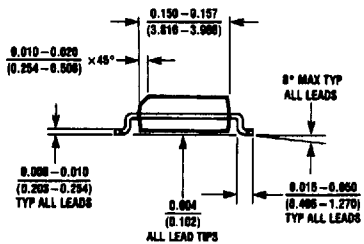
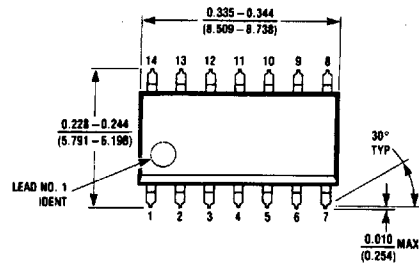

M14A (REV H)

### 16 Lead (0.150" Wide) Molded Small Outline Package, JEDEC NS Package Number M16A

All dimensions are in inches (millimeters)

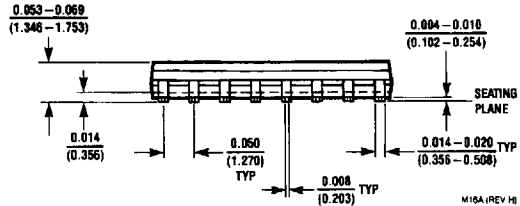
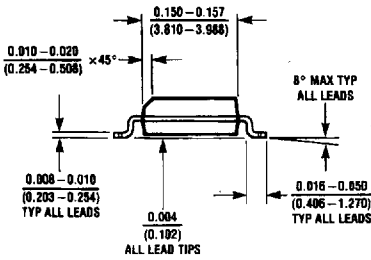
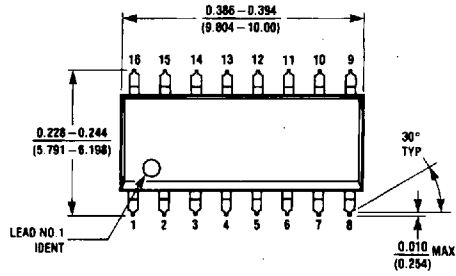

M16A (REV B)

### 20 Lead (0.300" Wide) Molded Small Outline Package, JEDEC NS Package Number M20B

All dimensions are in inches (millimeters)

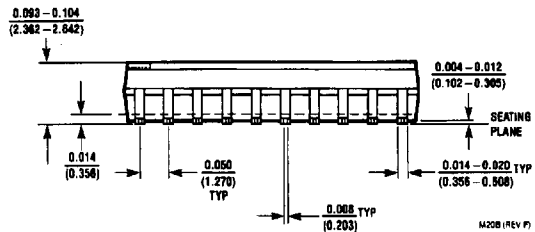
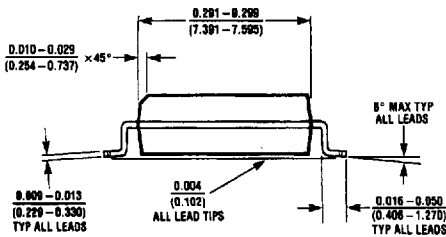
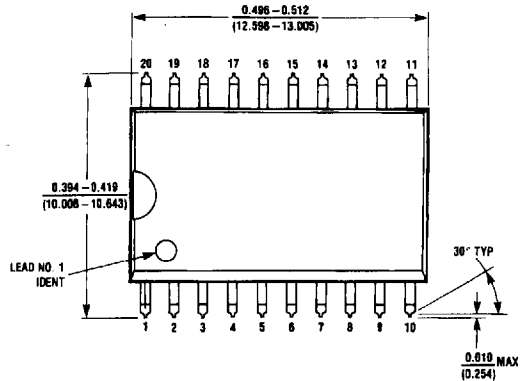

M20B (REV F)

### 28 Lead (0.300" Wide) Molded Small Outline Package, JEDEC NS Package Number M28B

All dimensions are in inches (millimeters)

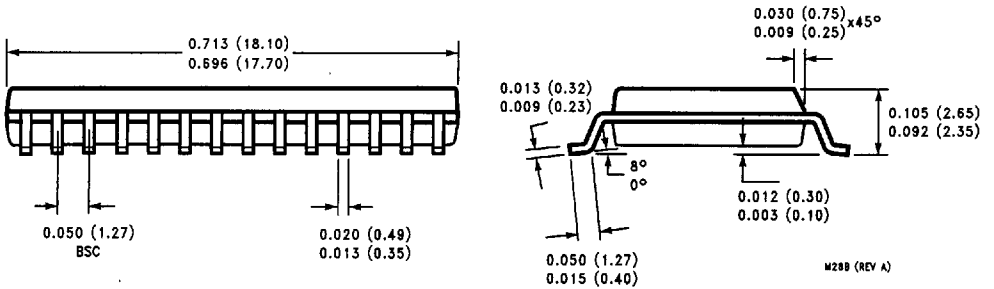
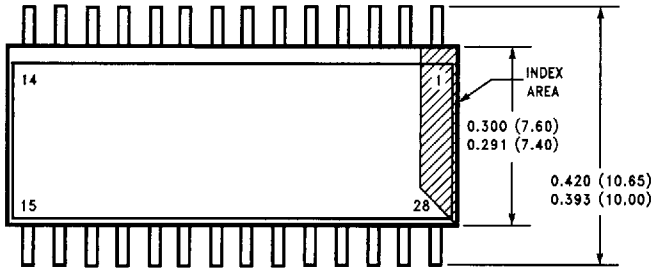

### 14 Lead (0.300" Wide) Molded Dual-in-Line Package NS Package Number N14A

All dimensions are in inches (millimeters)

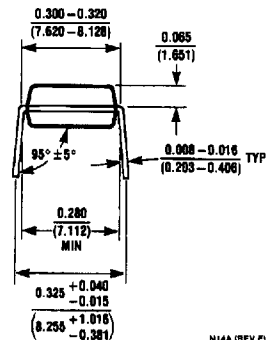
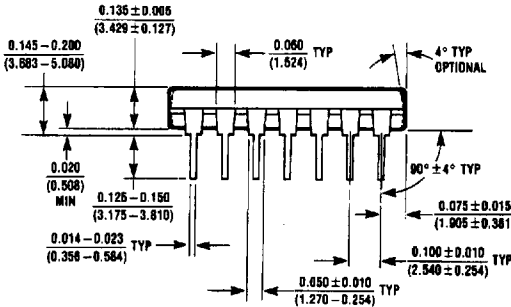
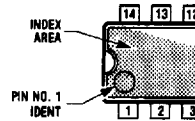
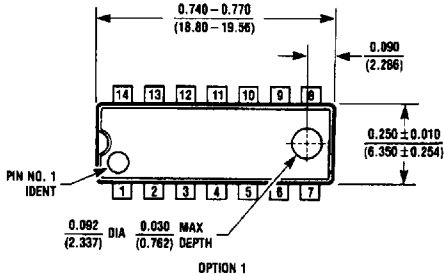

N14A (REV F)

### 16 Lead (0.300" Wide) Molded Dual-in-Line Package NS Package Number N16E

All dimensions are in inches (millimeters)

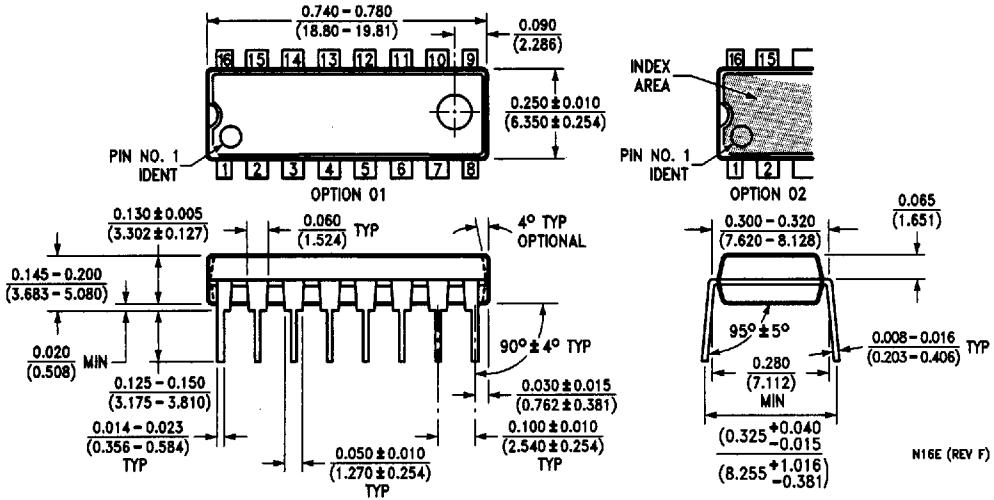

### 20 Lead (0.300" Wide) Molded Dual-in-Line Package NS Package Number N20A

All dimensions are in inches (millimeters)

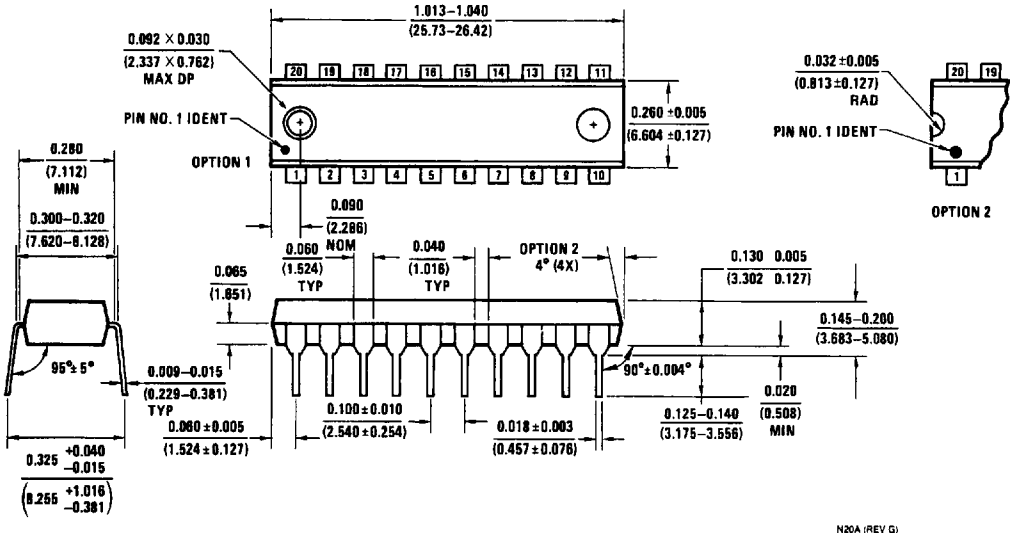



# 28 Lead Molded Plastic Leaded Chip Carrier NS Package Number V28A

All dimensions are in inches [millimeters]

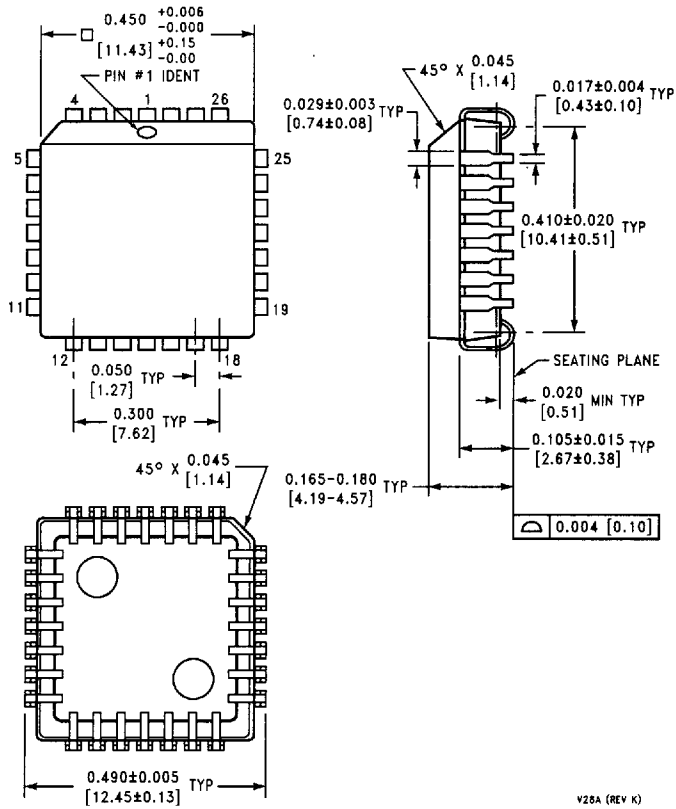

V28A (REV K)