



CERAMIC

High Pass Filter

HFCN-1500+

50Ω 1600 to 5500 MHz

THE BIG DEAL

- Small size
- 7 sections
- Temperature stable
- Excellent power handling, 7W
- Hermetically sealed
- LTCC construction
- Low cost

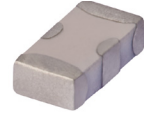

Generic photo used for illustration purposes only

CASE STYLE: FV1206

+RoHS Compliant

The +Suffix identifies RoHS Compliance. See our web site for RoHS Compliance methodologies and qualifications

APPLICATIONS

- Sub-harmonic rejection
- Transmitters/receivers
- Lab use

ELECTRICAL SPECIFICATIONS^{1,2} AT 25°C

Parameter	Frequency (MHz)	Min.	Typ.	Max.	Units	
Stop Band	Rejection Loss	1060	40	—	—	dB
		1250	20	—	—	
	Freq. Cut-Off	1550	—	3.0	—	dB
	VSWR	1060-1250	—	20	—	:1
Pass Band	Insertion Loss	1600-5500	—	2.0	—	dB
		1850-4400	—	—	1.3	dB
	VSWR	1620-3450	—	1.5	—	:1

1. In Application where DC voltage is present at either input or output ports, coupling capacitors are required. Alternatively, Mini-Circuits' "D" suffix version of this model will provide >100 MOhm isolation to ground.

2. Measured on Mini-Circuits Characterization Test Board TB-270.

MAXIMUM RATINGS

Parameter	Ratings
Operating temperature	-55°C to 100°C
Storage temperature	-55°C to 100°C
RF Power Input ³	7 W max. at 25°C

3. Passband rating, derate linearly to 3W at 100°C ambient. Permanent damage may occur if any of these limits are exceeded.

TYPICAL FREQUENCY RESPONSE

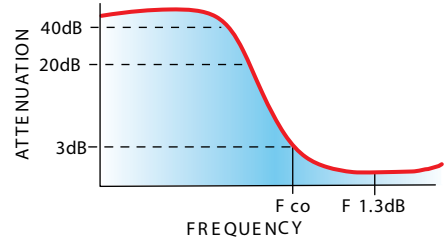

FUNCTIONAL SCHEMATIC

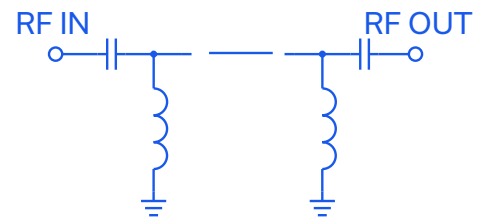

REV. M
ECO-011980
HFCN-1500+
AD/CP/AM
220221



PIN CONNECTIONS

RF IN	1
RF OUT	3
GROUND	2,4

PRODUCT MARKING: N/A

DEMO BOARD MCL P/N: TB-270
SUGGESTED PCB LAYOUT (PL-137)

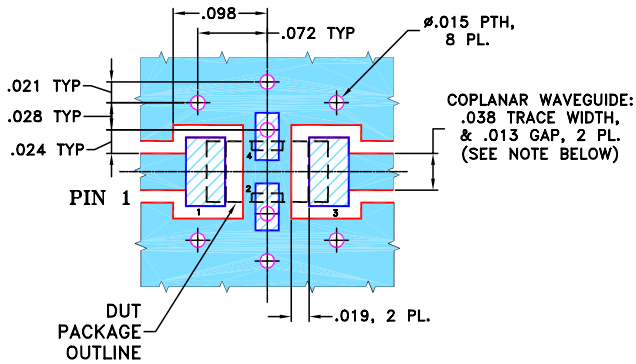

- NOTES:**
1. COPLANAR WAVEGUIDE PARAMETERS ARE SHOWN FOR ROGERS RO4350B WITH THICKNESS .020" ± .0015". COPPER: 1/2 OZ. EACH SIDE. FOR OTHER MATERIALS TRACE WIDTH & GAP MAY NEED TO BE MODIFIED.
 2. BOTTOM SIDE OF THE PCB IS CONTINUOUS GROUND PLANE.

- DENOTES PCB COPPER LAYOUT WITH SMOBC (SOLDER MASK OVER BARE COPPER)
- DENOTES COPPER LAND PATTERN FREE OF SOLDER MASK

OUTLINE DRAWING

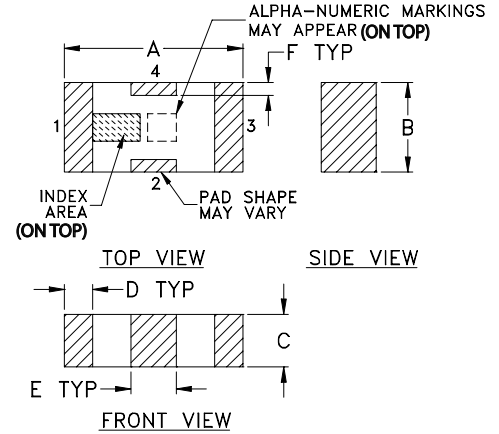

PCB Land Pattern

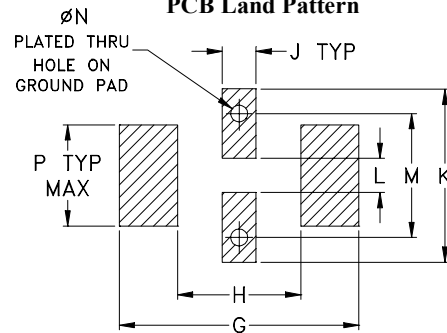

Suggested Layout,
Tolerance to be within ±.002

OUTLINE DIMENSIONS (Inches mm)

A	B	C	D	E	F	G	
.126	.063	.037	.020	.032	.009	.169	
3.20	1.60	0.94	0.51	0.81	0.23	4.29	
H	J	K	L	M	N	P	wt
.087	.024	.122	.024	.087	.012	.071	grams
2.21	0.61	3.10	0.61	2.21	0.30	1.80	.020

TAPE & REEL INFORMATION: F71



CERAMIC

High Pass Filter

HFCN-1500+

TYPICAL PERFORMANCE DATA AT 25°C

Frequency (MHz)	Insertion Loss (dB)	VSWR (:1)
1.00	105.45	1737.18
100.00	63.65	579.06
1060.00	48.22	46.96
1250.00	31.52	28.03
1400.00	14.81	12.89
1480.00	7.64	5.56
1550.00	3.50	2.35
1600.00	2.13	1.54
1620.00	1.83	1.41
1850.00	1.00	1.49
2000.00	0.76	1.31
3450.00	0.45	1.15
4400.00	0.94	1.82
5500.00	2.10	3.04
7000.00	3.85	4.99
9000.00	5.89	5.89

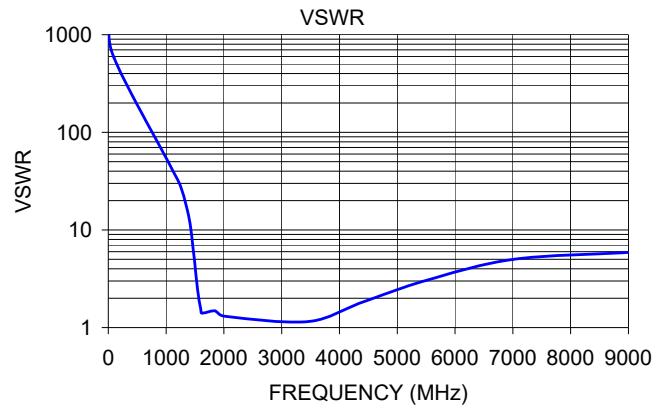

- NOTES**
- A. Performance and quality attributes and conditions not expressly stated in this specification document are intended to be excluded and do not form a part of this specification document.
 - B. Electrical specifications and performance data contained in this specification document are based on Mini-Circuit's applicable established test performance criteria and measurement instructions.
 - C. The parts covered by this specification document are subject to Mini-Circuits standard limited warranty and terms and conditions (collectively, "Standard Terms"); Purchasers of this part are entitled to the rights and benefits contained therein. For a full statement of the standard. Terms and the exclusive rights and remedies thereunder, please visit Mini-Circuits' website at www.minicircuits.com/MCLStore/terms.jsp

