

Ceramic High Pass Filter

HFCW-5000+

50Ω 5500 to 20000 MHz

The Big Deal

- Very good rejection, 45 dB typical
- Small size 0603 (0.063" X 0.032" X 0.024")
- Good Power handling, 1.75W
- Ceramic construction



Generic photo used for illustration purposes only
CASE STYLE: JC0603C

Product Overview

HFCW-5000+ is a high pass filter with passband from 5500 MHz to 20000 MHz supporting a variety of applications. This model provides good insertion loss over a wide band due to strategically constructed layout. Housed in a tiny 0603 ceramic form factor with wraparound terminations, the filter is ideal for dense PCB layouts with minimal performance variation due to parasitics.

Key Features

Feature	Advantages
Small size, 0603 (0.063" X 0.032" X 0.024")	Accommodates tight space requirements for dense PCB layouts.
Wrap around termination	Provides excellent solderability and easy visual inspection capability.
LTCC construction	Provides a rugged package that is well suited for tough environments including high humidity and high temperature extremes.
Ultra-wide pass band	This filter has a very wide passband from 5.5 GHz to 20 GHz.

Notes

- A. Performance and quality attributes and conditions not expressly stated in this specification document are intended to be excluded and do not form a part of this specification document.
B. Electrical specifications and performance data contained in this specification document are based on Mini-Circuit's applicable established test performance criteria and measurement instructions.
C. The parts covered by this specification document are subject to Mini-Circuits standard limited warranty and terms and conditions (collectively, "Standard Terms"); Purchasers of this part are entitled to the rights and benefits contained therein. For a full statement of the Standard Terms and the exclusive rights and remedies thereunder, please visit Mini-Circuits' website at www.minicircuits.com/MCLStore/terms.jsp



Ceramic High Pass Filter

HFCW-5000+

50Ω 5500 to 20000 MHz



Generic photo used for illustration purposes only
CASE STYLE: JC0603C

+RoHS Compliant

The +Suffix identifies RoHS Compliance. See our web site for RoHS Compliance methodologies and qualifications

Features

- Very good rejection, 45 dB typ.
- Small size 0603 (0.063" X 0.032" X 0.024")
- Temperature stable
- LTCC construction

Applications

- Test and measurements
- Military applications
- Telecommunications and broadband wireless systems

Electrical Specifications^(1,2) at 25°C

Parameter		F#	Frequency (MHz)	Min.	Typ.	Max.	Unit
Stop Band	Rejection Loss	DC-F1	DC - 3000	39	45	-	dB
		F1-F2	3000 - 4000	20	40	-	dB
	Freq. Cut-Off	F3	5000	-	3.0	-	dB
Pass Band	Insertion Loss	F4-F5	5500 - 7000	-	2.2	-	dB
		F5-F6	7000 - 13500	-	0.9	1.4	dB
		F6-F7	13500 - 20000	-	2.0	-	dB
	Return Loss	F4-F7	5500 - 20000	-	9	-	dB

1 This component is not intended to act as a DC block. Please consult with Mini-Circuits for further details
2 Measured on Mini-Circuits Characterization Test Board TB-HFCW-5000+

Functional Schematic

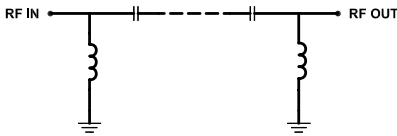

Maximum Ratings

Operating Temperature	-55°C to 125°C
Storage Temperature	-55°C to 125°C
RF Power Input*	1.75W @ 25°C

* Passband rating, derate linearly to 0.5W at 125°C ambient
Permanent damage may occur if any of these limits are exceeded.

Typical Performance Data at 25°C

Frequency (MHz)	Insertion Loss (dB)	Return Loss (dB)
10	82.88	0.08
100	68.86	0.10
500	53.21	0.15
1000	48.20	0.18
2000	47.21	0.18
3000	58.91	0.20
3500	71.26	0.28
4000	66.10	0.45
4450	30.12	0.90
4630	20.28	1.42
4840	9.93	3.56
5000	4.53	9.72
5500	1.52	15.55
6000	0.89	28.99
7000	0.54	28.57
10000	0.35	29.07
13500	0.42	16.47
15000	0.54	13.55
18000	0.98	10.46
20000	1.10	15.36

Typical Frequency Response

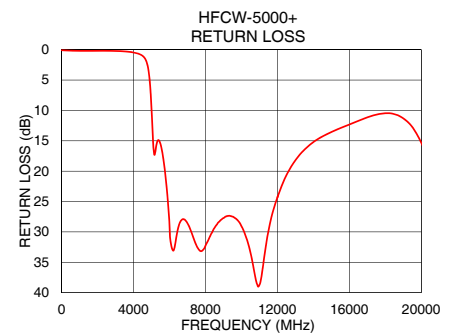
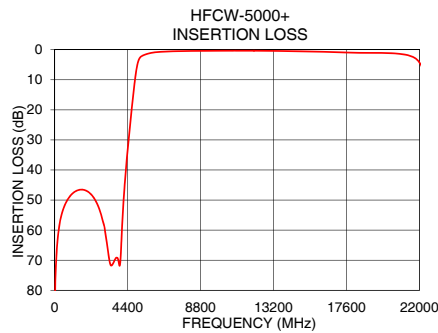
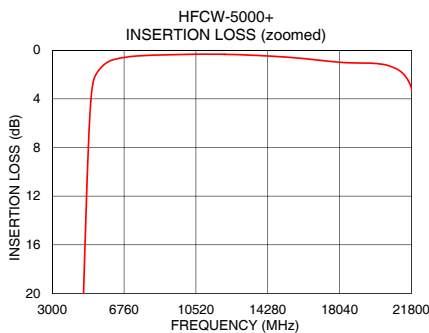
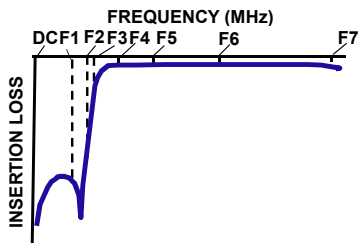

Notes

- A. Performance and quality attributes and conditions not expressly stated in this specification document are intended to be excluded and do not form a part of this specification document.
B. Electrical specifications and performance data contained in this specification document are based on Mini-Circuit's applicable established test performance criteria and measurement instructions.
C. The parts covered by this specification document are subject to Mini-Circuits standard limited warranty and terms and conditions (collectively, "Standard Terms"); Purchasers of this part are entitled to the rights and benefits contained therein. For a full statement of the Standard Terms and the exclusive rights and remedies thereunder, please visit Mini-Circuits' website at www.minicircuits.com/MCLStore/terms.jsp



www.minicircuits.com P.O. Box 350166, Brooklyn, NY 11235-0003 (718) 934-4500 sales@minicircuits.com

REV. OR
ECO-011218
HFCW-5000+
EDU4258
URJ
211222
Page 2 of 3

Pad Connections



INPUT	1
OUTPUT	3
GROUND	2,4,5,6

Product Marking: 3

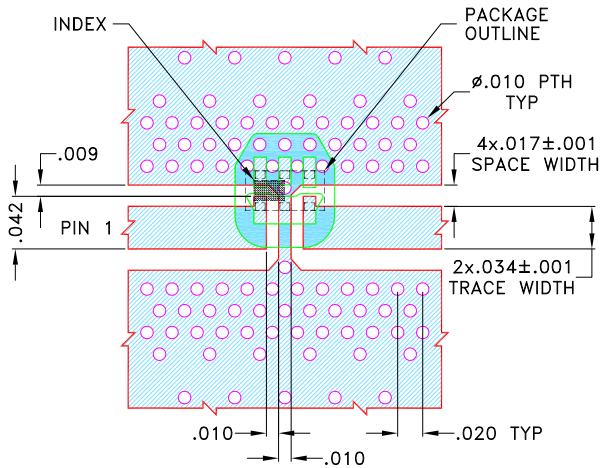
Demo Board MCL P/N: TB-HFCW-5000+
Suggested PCB Layout (PL-703)



NOTES:

- COPLANAR WAVEGUIDE PARAMETERS ARE SHOWN FOR ROGERS (RO4350B) WITH DIELECTRIC THICKNESS .0200±.0015. COPPER: 1/2 Oz. EACH SIDE. FOR OTHER MATERIALS TRACE WIDTH AND GAP MAY NEED TO BE MODIFIED.
 - BOTTOM SIDE OF THE PCB IS CONTINUOUS GROUND PLANE.
-  DENOTES PCB COPPER PATTERN WITH SMOBC (SOLDER MASK OVER BARE COPPER)
 DENOTES PCB COPPER PATTERN FREE OF SOLDERMASK

Outline Drawing

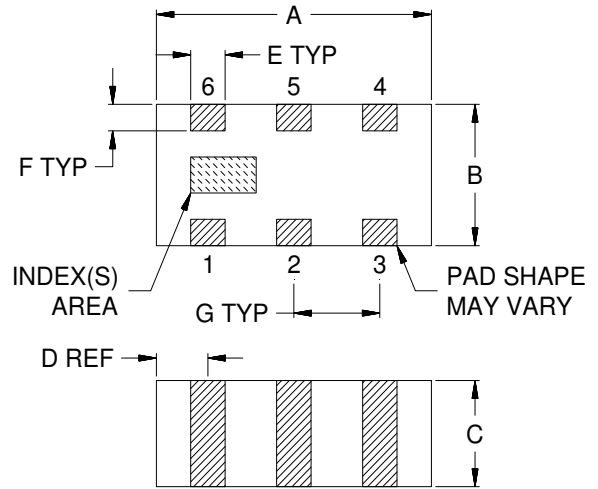

Outline Dimensions (inch)

A	B	C	D	E	F	G	Wt.
.063	.032	.024	.012	.008	.006	.020	grams
1.60	0.80	0.60	0.30	0.20	0.15	0.50	.005

Note: Please refer to case style drawing for details.

Notes

- A. Performance and quality attributes and conditions not expressly stated in this specification document are intended to be excluded and do not form a part of this specification document.
 B. Electrical specifications and performance data contained in this specification document are based on Mini-Circuit's applicable established test performance criteria and measurement instructions.
 C. The parts covered by this specification document are subject to Mini-Circuits standard limited warranty and terms and conditions (collectively, "Standard Terms"); Purchasers of this part are entitled to the rights and benefits contained therein. For a full statement of the Standard Terms and the exclusive rights and remedies thereunder, please visit Mini-Circuits' website at www.minicircuits.com/MCLStore/terms.jsp