

TOLERANCE UNLESS OTHERWISE SPECIFIED	
.X	±---
.XX	±---
.XXX	±.005

THIS IS A C.A.D. GENERATED DRAWING  
DO NOT MAKE MANUAL REVISIONS TO MASTER.

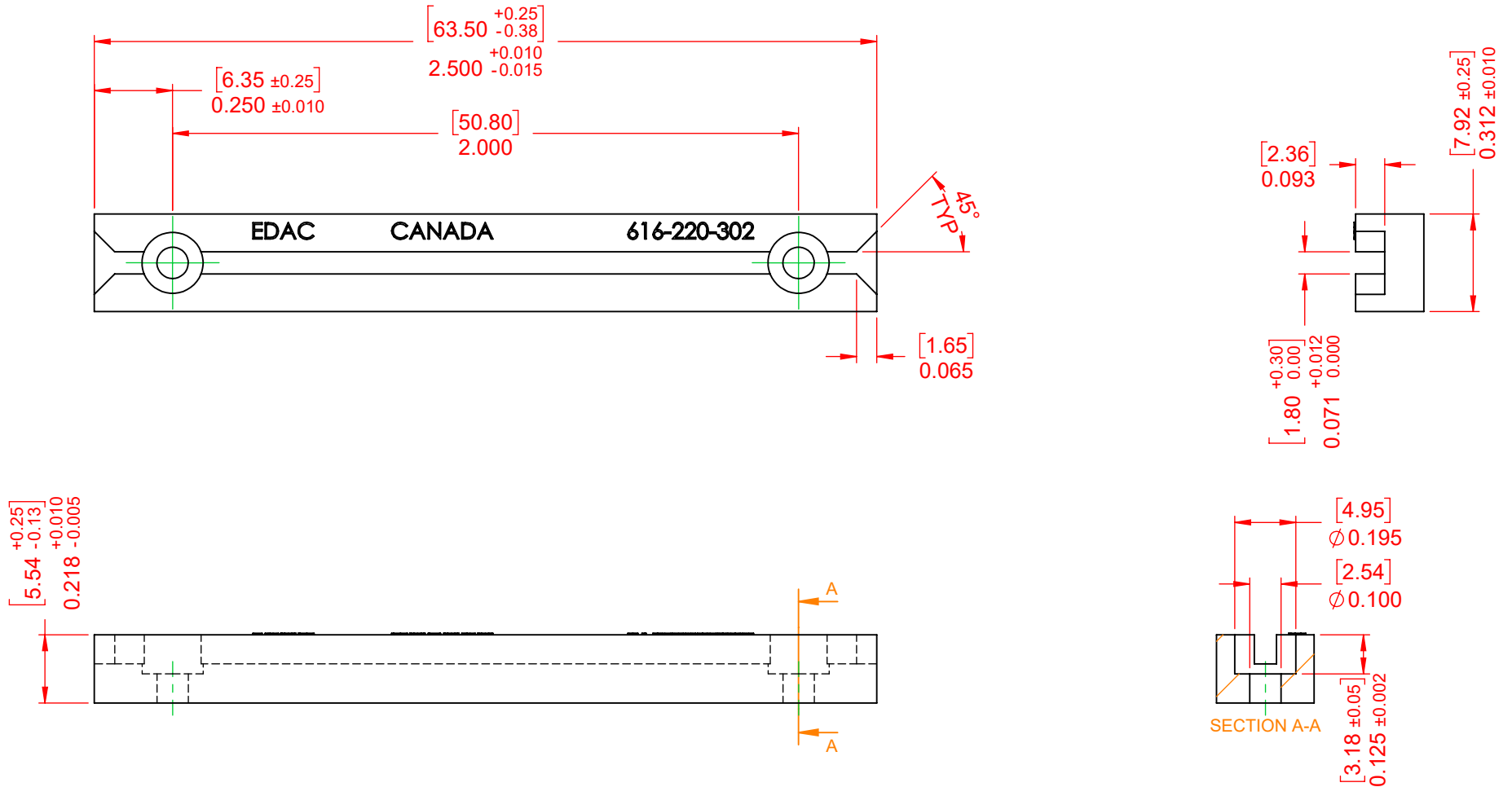

ISSUE NUMBER	
ORIGINAL	①
CONVERTED TO SW2020 C.B AUG, 20/2020	②



NOTE:  
MATERIAL & FINISH: THERMOPLASTIC POLYESTER, UL94V-0 RATED, GREY IN COLOR



THIS SERIES FULLY CONFORMS TO  
THE EUROPEAN UNION DIRECTIVES  
2011/65/EU FOR RoHS COMPLIANCY.



YOUR CONNECTION TO QUALITY & SERVICE

EDAC INC  
TORONTO, ONTARIO  
CANADA

THESE DRAWINGS AND SPECIFICATIONS  
ARE THE PROPERTY OF EDAC INC., AND  
SHALL NOT BE REPRODUCED, OR COPIED  
OR USED AS THE BASIS FOR THE  
MANUFACTURE OR SALE OF APPARATUS  
WITHOUT WRITTEN PERMISSION.

616 SERIES UNI-GUIDE		ACAD REFERENCE NO.: 616-220-001	
		DRAWN: F. BIRONES	DATE: APR, 17/1997
CHECKED:		DATE:	
SCALE: 2:1		SHEET 1 OF 1	
DRAWING NUMBER: 616-220-001			ISSUE
PART NUMBER: 616-220-302			23