

ZWS-PAF SERIES Single Output 150W, 240W

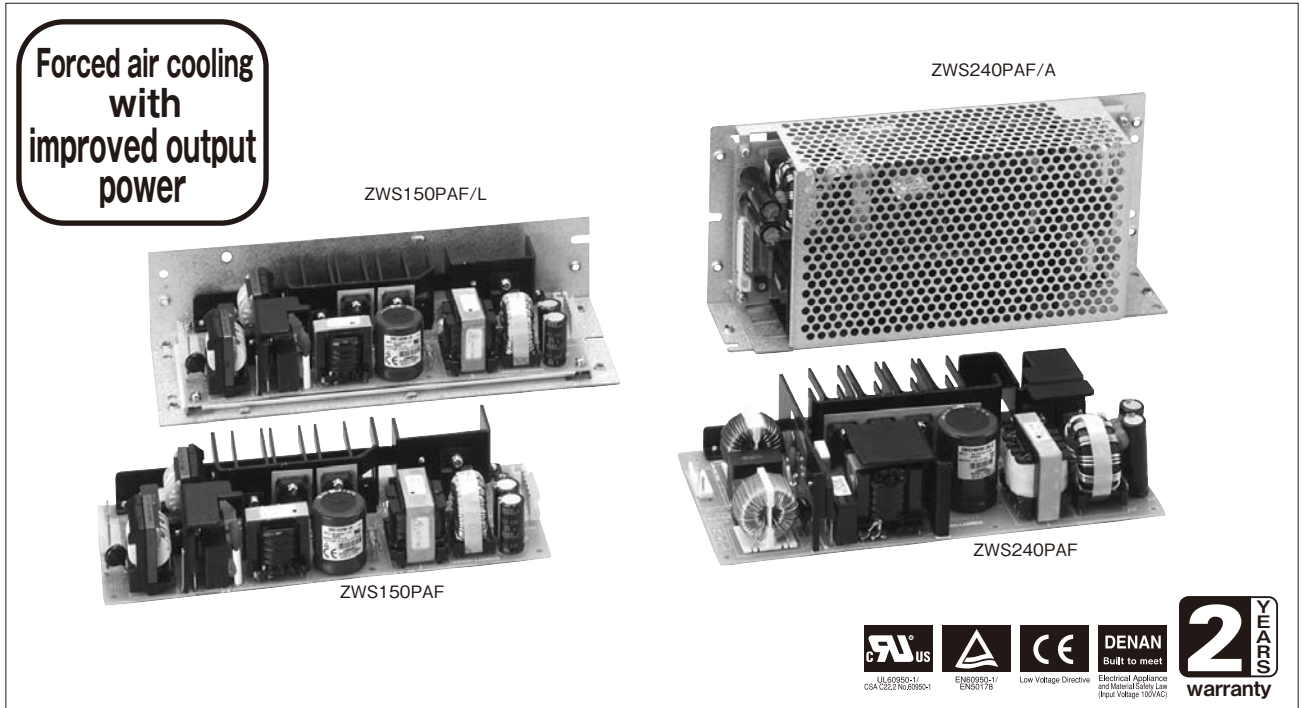

■ Features



Complies the standard of the harmonics current limit

- Power supply for motor drive in mechatronics products: Applicable for 24V pulse load
- Ultracompact and high power: Peak power of twice the value of average power
- Worldwide input voltage range: 85-265VAC
- Complies the harmonics current limit standard: Built-in active filter
- Small leak current: Convenient for use in combination with power supply for logic (use of multiple units of power supply)
- A wide variety of optional items/Harmonics current limiter

■ Applications

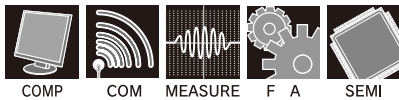

■ Product Line up

Output Voltage	150W		240W	
	Current (Peak)	Model	Current (Peak)	Model
24V	6.3A (12A)	ZWS150PAF-24/J	10A (20A)	ZWS240PAF-24/J
36V	4.2A (8A)	ZWS150PAF-36/J	6.7A (13.3A)	ZWS240PAF-36/J
48V	3.1A (6A)	ZWS150PAF-48/J	5A (10A)	ZWS240PAF-48/J

■ Model naming method

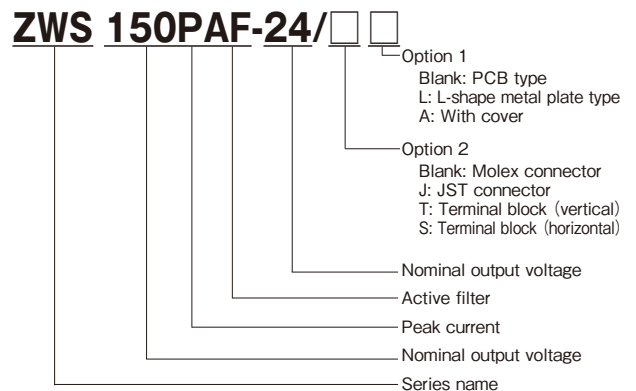

■ Conformity to RoHS Directive

This means that, in conformity with EU Directive 2002/95/EC, lead, cadmium, mercury, hexavalent chromium, and specific bromine-based flame retardants, PBB and PBDE, have not been used, except for exempted applications.

ZWS150PAF (Convection Cooling) Specifications

ITEMS/UNITS		MODEL	ZWS150PAF-24/J	ZWS150PAF-36/J	ZWS150PAF-48/J
Input	Voltage Range	(*3) V	AC85 - 265 or DC120 - 370		
	Frequency	(*3) Hz	47-63		
	Power Factor (100/200VAC)(typ)	(*2)	0.99 / 0.95		
	Efficiency (typ)	(*2) %	82		
	Current (100/200VAC)(typ)	(*2) A	2.0 / 1.0		
	Inrush Current (100/200VAC)(typ)(*4)	A	14 / 28 at Ta=25°C, cold start		
	Leakage Current	(*10) mA	0.5 Max, 0.1 (typ) at 100VAC / 0.16 (typ) at 230VAC		
Output	Nominal Voltage	VDC	24	36	48
	Maximum Current	A	6.3	4.2	3.1
	Maximum Peak Current	(*1) A	12	8	6
	Maximum Power	W	151.2		
	Maximum Peak Power	(*1) W	288		
	Maximum Line Regulation	(*5)(*6) mV	96	144	192
	Maximum Load Regulation	(*5)(*7) mV	192	288	384
	Temperature Coefficient		Less than 0.02%/°C		
	Maximum Ripple & Noise (0≤Ta≤60°C)	(*5) mVp-p	240	360	480
	Maximum Ripple & Noise (-10≤Ta<0°C)	(*5) mVp-p	360	540	720
	Hold-up Time (typ)	(*2) ms	20		
	Function	Voltage Adjustable Range	VDC	21.6 - 28.8	32.4 - 41.4
Over Current Protection		(*8) VDC	> 12.3	> 8.2	> 6.1
Over Voltage Protection		(*9) VDC	30.0 - 35.0	43.2 - 50.4	55.2 - 64.8
Remote ON/OFF Control			Possible		
Parallel Operation			-		
Series Operation			Possible		
Environment		Operating Temperature	(*11) °C	- 10 to + 60 Convection: -10 to +50 (100%); 60 (70%)	
	Storage Temperature	°C	- 30 to +85		
	Operating Humidity	%RH	30 - 90 (No dewdrop)		
	Storage Humidity	%RH	10 - 95 (No dewdrop)		
	Vibration		At no operating, 10 - 55Hz (sweep for 1min) 19.6m/s² constant, X, Y, Z 1 hour each		
	Shock (In package)		Less than 196.1m/s²		
Isolation	Cooling		Convection cooling		
	Withstand Voltage		Input - Output : 3.0kVAC (20mA), Input - FG : 2.0kVAC (20mA) Output - FG : 500VAC (100mA) for 1min.		
	Isolation Resistance		More than 100MΩ at Ta=25°C and 70%RH, Output - FG : 500VDC		
Standards	Safety Standards	(*12)	Approved by UL60950-1, CSA C22.2 No.60950-1, EN60950-1 Built to meet DENAN		
	PFHC		Built to meet EN61000-3-2		
	EMI	(*13)	Built to meet VCCI-B, FCC-Class B, EN55011/EN55022-B		
	Immunity		Built to meet EN61000-4-2,-3,-4,-5,-6,-8,-11		
Mechanical	Weight (typ)	g	500		
	Size (W x H x D)	mm	80 x 40 x 208 (Refer to outline drawing)		

(*1) Operating period at peak output current is less than 10 sec. (Duty ≤ 0.35)
(Average output power and current is less than maximum output power and current.)
For peak load derating method, please refer to instruction manual for details.

(*2) At 100/200VAC and maximum output power, Ta = 25°C.

(*3) For cases where conformance to various safety specs (UL, CSA, EN) are required, to be described as 100-240VAC, 50/60Hz on name plate.

(*4) Not applicable for the in-rush current to noise filter for less than 0.2ms.

(*5) Please refer to Fig A for measurement of line & load regulation and output ripple voltage.
(Measure with JEITA RC-9131 probe.)

(*6) 85-265VAC, constant load.

(*7) No load - full load (maximum power), constant input voltage.

(*8) Constant current limit with automatic recovery. Avoid to operate at overload or dead short for more than 30 seconds.

(*9) OVP circuit will shutdown output, manual reset. (Line recycle)

(*10) Measured by each measuring method of UL, CSA, EN and DENAN (at 60Hz).

(*11) At standard mounting method, Fig B.
-Load(%) is percent of maximum output load, do not exceed derating in both maximum output current and power.
-For other mountings, refer to derating curve.
-When forced air cooling, refer to derating curve.

(*12) As for DENAN, built to meet at 100VAC.

(*13) 85-265VAC, no load - full load, constant load.

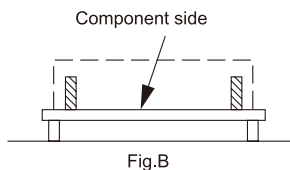
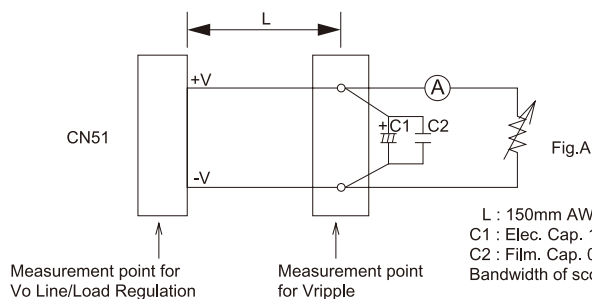

● Recommended EMC Filter



RSEL-2006W

Please refer to "TDK-Lambda EMC Filters" catalog.

ZWS150PAF (Forced Air Cooling) Specifications

ITEMS/UNITS		MODEL	ZWS150PAF-24	ZWS150PAF-36	ZWS150PAF-48
Input	Voltage Range	(*3) V	AC85 - 265 or DC120 - 370		
	Frequency	(*3) HZ	47-63		
	Current (100/200VAC)(typ)	(*4) A	2.8 / 1.4		
Output	Nominal Voltage	VDC	24	36	48
	Maximum Current	(*1) A	8.4	5.6	4.3
	Maximum Peak Current	(*2) A	12	8	6
	Maximum Power	(*1) W	201.6		206.4
	Maximum Peak Power	(*2) W	288		
	Hold-Up Time (typ)	(*4) ms	16		
Environment	Operating Temperature	(*5)(*6) °C	-10 to +70 -10 to +50 (100%); 60 (91%); 70 (70%)		
	Cooling	(*1)	Forced air cooling		
Standards	EMI	(*7)	Built to meet VCCI-A, FCC-Class A, EN55011/EN55022-A		

- (*1) Forced air cooling with air velocity more than 1.5m/s (measured at component side of PCB, air must flow through component side)
- (*2) Operating period at peak output current is less than 10sec. (Duty ≤ 0.35)
(Average output power and current is less than Maximum output power and current.)
For peak load derating method, please refer to instruction manual for details.
- (*3) For cases where conformance to various safety specs (UL, CSA, EN) are required, to be described as 100-240VAC, 50/60Hz on name plate.
- (*4) At 100/200VAC and maximum output power, Ta = 25°C.
- (*5) At standard mounting method A, and other mountings B, C, D, E.
- Load(%) is percent of maximum output load, do not exceed derating in both maximum output current and power.
- (*6) Output derating for cold start up at Ta = - 10°C for input voltage : 85VAC 80%, 90VAC 86.7%, 100-265VAC 100%.
No output derating for input voltage is required after start up for one second.
- (*7) 85-265VAC, Full load.

● Recommended EMC Filter

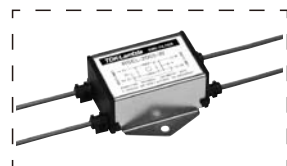

RSEL-2006W
Please refer to "TDK-Lambda EMC Filters" catalog.

Outline Drawing

[ZWS150PAF (/J : JST connector)]

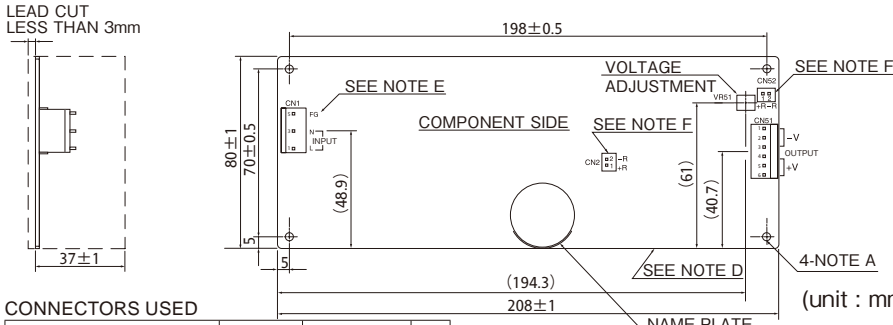

- NOTES:**
- A. THE 4-φ3.5 HOLES ARE CUSTOMER'S CHASSIS MOUNTING HOLES. ALL MUST BE SCREWED IN ORDER TO CONFORM TO THE VIBRATION SPEC.
 - B. MODEL NAME, INPUT VOLTAGE RANGE, NOMINAL OUTPUT VOLTAGE, MAXIMUM OUTPUT CURRENT ARE SHOWN HERE IN ACCORDANCE WITH THE SPECIFICATIONS.
 - C. COUNTRY OF MANUFACTURE WILL BE SHOWN HERE.
 - D. TO KEEP THE DISTANCE MORE THAN 4m/m BETWEEN PC-BOARD EDGE AND CUSTOMER'S CHASSIS.
 - E. FG IS FOR SAFETY GROUND CONNECTION.
 - F. REMOTE ON/OFF CONTROL CONNECTOR (CN2, CN52)
 * B2B-XH-AM (J.S.T.)
 * CN2 IS NORMALLY SHORTED BY JM-2W-96(J.S.T.)
 MATCHING HOUSING : XHP-2(J.S.T.)
 MATCHING TERMINAL : BXH-001T-P0.6 (J.S.T.)OR SXH-001T-P0.6 (J.S.T.)
 HAND CRIMPING TOOL : YC-110R OR YRS-110
 MANUFACTURER : J.S.T.

CONNECTORS USED

PART DESCRIPTION	PART NAME	MANUFACTURER	QTY
PIN HEADER (INPUT SIDE CN1)	B3P-5-VH	J.S.T.	1
PIN HEADER (OUTPUT SIDE CN51)	B6P-VH	J.S.T.	1

MATCHING HOUSINGS & PIN.

* NOT INCLUDED WITH THE PRODUCT.

SOCKET HOUSING (CN1)	VHR-5N	J.S.T.	1
SOCKET HOUSING (CN51)	VHR-6N	J.S.T.	1
TERMINAL PINS (CN1, CN51)	SVH-21T-P1.1	J.S.T.	9

HAND CRIMPING TOOL : YC-160R MANUFACTURER : J.S.T.

[ZWS150PAF (/JL : With L-shape metal plate, JST connector)]

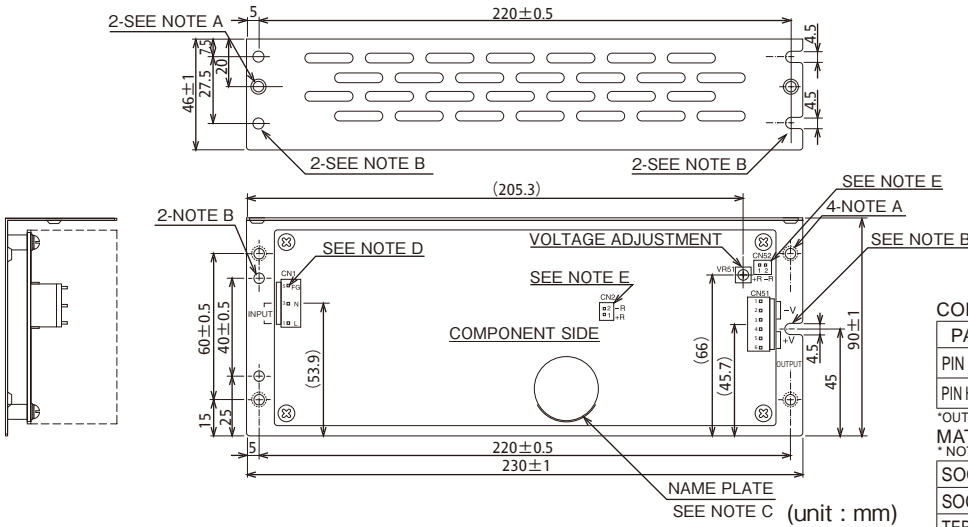

- NOTES:**
- A: M4 EMBOSSED TAPPED & COUNTERSUNK HOLES (6) ARE FOR CUSTOMER CHASSIS MOUNTING. SCREW MUST NOT PROTRUDE INTO POWER SUPPLY BY MORE THAN 6mm.
 - B: φ4.5 HOLES (4) AND R2.25 SLOT HOLES (3) ARE FOR CUSTOMER CHASSIS MOUNTING. (USE M4 MOUNTING SCREW.)
 - C: MODEL NAME, NOMINAL INPUT VOLTAGE, NOMINAL OUTPUT VOLTAGE, MAXIMUM OUTPUT CURRENT, PEAK OUTPUT CURRENT AND COUNTRY OF MANUFACTURE ARE SHOWN HERE IN ACCORDANCE WITH THE SPECIFICATIONS.
 - D: FG IS FOR SAFETY GROUND CONNECTION.
 - E: REMOTE ON/OFF CONTROL CONNECTOR (CN2, CN52)
 * B2B-XH-AM (J.S.T.)
 * CN2 IS NORMALLY SHORTED BY JM-2W-96(J.S.T.)
 MATCHING HOUSING : XHP-2 (J.S.T.)
 MATCHING TERMINAL : BXH-001T-P0.6 (J.S.T.) OR SXH-001T-P0.6 (J.S.T.)
 HAND CRIMPING TOOL : YC-110R OR YRS-110 MANUFACTURER : J.S.T.

CONNECTORS USED

PART DESCRIPTION	PART NAME	MANUFACTURER	QTY
PIN HEADER (INPUT SIDE CN1)	B3P-5-VH	J.S.T.	1
PIN HEADER (OUTPUT SIDE CN51)	B6P-VH	J.S.T.	1

* OUTPUT CURRENT OF EACH CONNECTOR PIN MUST BE LESS THAN 5A.

MATCHING HOUSINGS & PIN.

* NOT INCLUDED WITH THE PRODUCT.

SOCKET HOUSING (CN1)	VHR-5N	J.S.T.	1
SOCKET HOUSING (CN51)	VHR-6N	J.S.T.	1
TERMINAL PINS (CN1, CN51)	SVH-21T-P1.1	J.S.T.	9

HAND CRIMPING TOOL : YC-160R MANUFACTURER : J.S.T.

[ZWS150PAF (/JA : With cover, JST connector)]

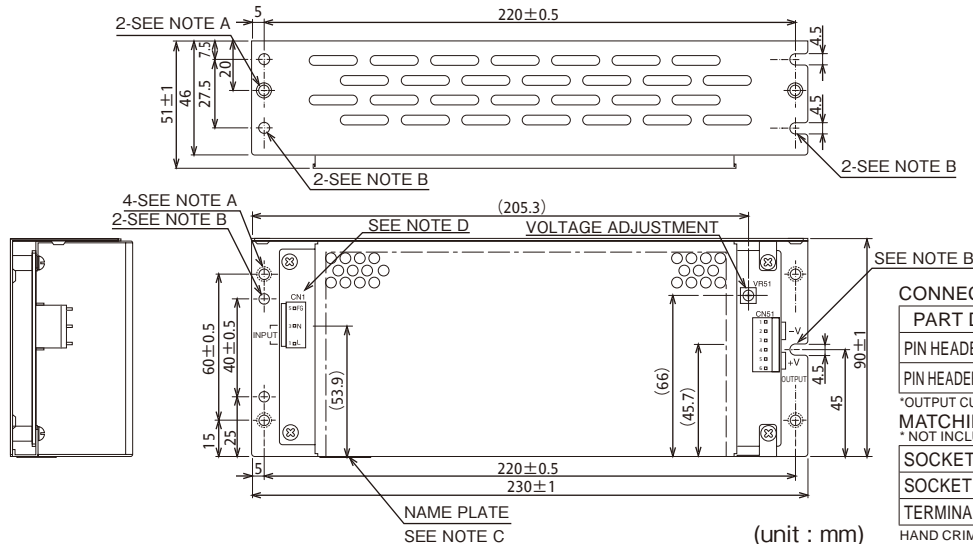

- NOTES:**
- A: M4 EMBOSSED TAPPED & COUNTERSUNK HOLES (6) ARE FOR CUSTOMER CHASSIS MOUNTING. SCREW MUST NOT PROTRUDE INTO POWER SUPPLY BY MORE THAN 6mm.
 - B: φ4.5 HOLES (4) AND R2.25 SLOT HOLES (3) ARE FOR CUSTOMER CHASSIS MOUNTING. (USE M4 MOUNTING SCREW.)
 - C: MODEL NAME, NOMINAL INPUT VOLTAGE, NOMINAL OUTPUT VOLTAGE, MAXIMUM OUTPUT CURRENT, PEAK OUTPUT CURRENT AND COUNTRY OF MANUFACTURE ARE SHOWN HERE IN ACCORDANCE WITH THE SPECIFICATIONS.
 - D: FG IS FOR SAFETY GROUND CONNECTION.

CONNECTORS USED

PART DESCRIPTION	PART NAME	MANUFACTURER	QTY
PIN HEADER (INPUT SIDE CN1)	B3P-5-VH	J.S.T.	1
PIN HEADER (OUTPUT SIDE CN51)	B6P-VH	J.S.T.	1

* OUTPUT CURRENT OF EACH CONNECTOR PIN MUST BE LESS THAN 5A.

MATCHING HOUSINGS & PIN.

* NOT INCLUDED WITH THE PRODUCT.

SOCKET HOUSING (CN1)	VHR-5N	J.S.T.	1
SOCKET HOUSING (CN51)	VHR-6N	J.S.T.	1
TERMINAL PINS (CN1, CN51)	SVH-21T-P1.1	J.S.T.	9

HAND CRIMPING TOOL : YC-160R MANUFACTURER : J.S.T.

Outline Drawing

[ZWS150PAF (/T : Vertical terminal)]

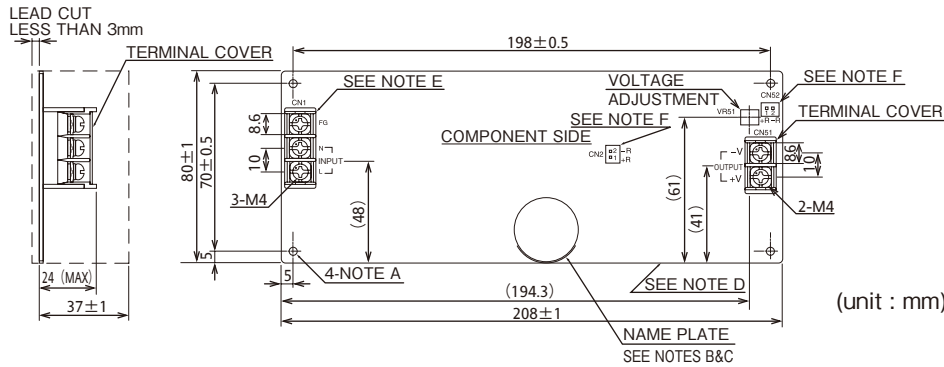

- NOTES:
- A. THE 4-φ3.5 HOLES ARE FOR CUSTOMER'S CHASSIS MOUNTING HOLES. ALL MUST BE SCREWED IN ORDER TO CONFORM THE VIBRATION SPEC.
 - B. MODEL NAME, INPUT VOLTAGE RANGE, NOMINAL OUTPUT VOLTAGE, MAXIMUM OUTPUT CURRENT ARE SHOWN HERE IN ACCORDANCE WITH THE SPECIFICATIONS.
 - C. COUNTRY OF MANUFACTURE WILL BE SHOWN HERE.
 - D. TO KEEP THE DISTANCE MORE THAN 4mm BETWEEN PC-BOARD EDGE AND CUSTOMER'S CHASSIS.
 - E. FG IS FOR SAFETY GROUND CONNECTION.
 - F. REMOTE ON/OFF CONTROL CONNECTOR (CN2, CN52) : B2B-XH-AM (J.S.T.)
*CN2 IS NORMALLY SHORTED BY JM-2W-96(J.S.T.)
MATCHING HOUSING : XHP-2 (J.S.T.)
MATCHING TERMINAL : BXH-001T-P0.6 (J.S.T.)
OR SXH-001T-P0.6 (J.S.T.)
HAND CRIMPING TOOL : YC-110R OR YRS-110
MANUFACTURER : J.S.T.

[ZWS150PAF (/TL : Vertical terminal, with L-shape metal plate)]

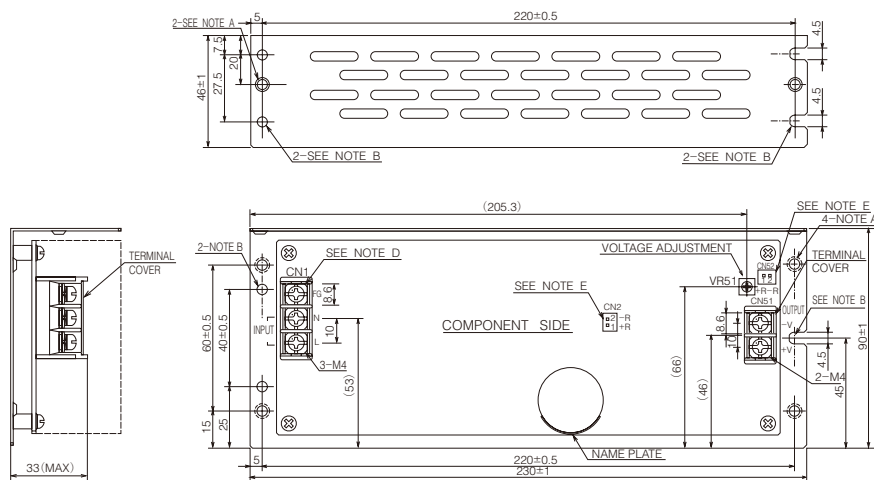

- NOTES
- A: M4 EMBOSSED TAPPED & COUNTERSUNK HOLES (6) ARE FOR CUSTOMER CHASSIS MOUNTING. SCREW MUST NOT PROTRUDE INTO POWER SUPPLY BY MORE THAN 6mm.
 - B: φ4.5 HOLES (4) AND R2.25 SLOT HOLES (3) ARE FOR CUSTOMER CHASSIS MOUNTING. (USE M4 MOUNTING SCREW.)
 - C: MODEL NAME, NOMINAL INPUT VOLTAGE, NOMINAL OUTPUT VOLTAGE, MAXIMUM OUTPUT CURRENT, PEAK OUTPUT CURRENT AND COUNTRY OF MANUFACTURE ARE SHOWN HERE IN ACCORDANCE WITH THE SPECIFICATIONS.
 - D: FG IS FOR SAFETY GROUND CONNECTION.
 - E: REMOTE ON/OFF CONTROL CONNECTOR (CN2, CN52) : B2B-XH-AM (J.S.T.)
*CN2 IS NORMALLY SHORTED BY JM-2W-96 (J.S.T.)
MATCHING HOUSING : XHP-2 (J.S.T.)
MATCHING TERMINAL : BXH-001T-P0.6 (J.S.T.) OR SXH-001T-P0.6 (J.S.T.)
HAND CRIMPING TOOL : YC-110R OR YRS-110 MANUFACTURER : J.S.T.

[ZWS150PAF (/TA : Vertical terminal, with cover)]

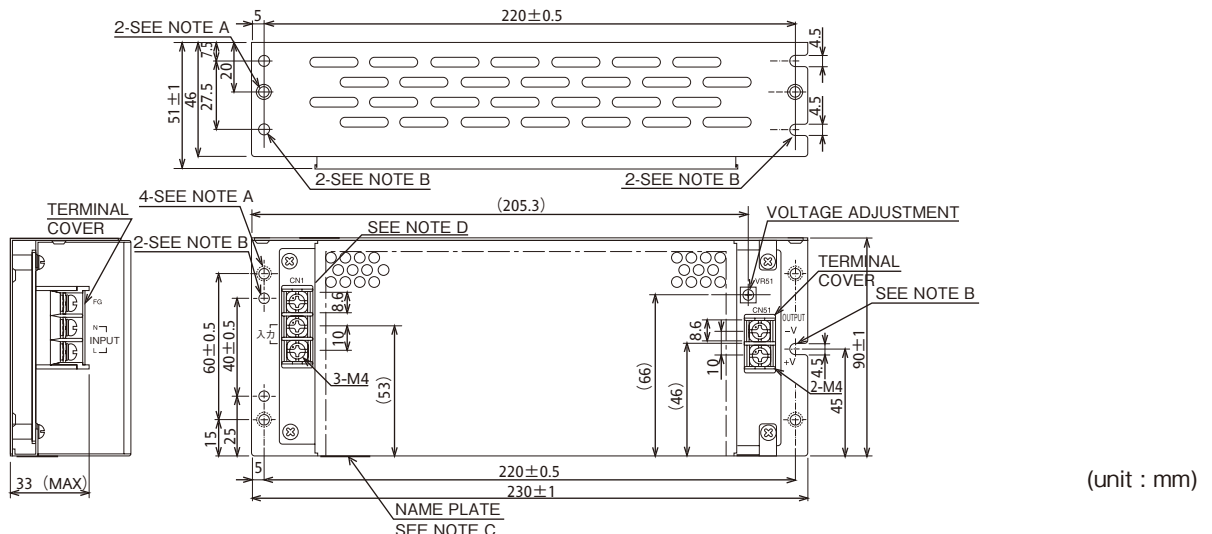

- NOTES
- A: M4 EMBOSSED TAPPED & COUNTERSUNK HOLES (6) ARE FOR CUSTOMER CHASSIS MOUNTING. SCREW MUST NOT PROTRUDE INTO POWER SUPPLY BY MORE THAN 6mm.
 - B: φ4.5 HOLES (4) AND R2.25 SLOT HOLES (3) ARE FOR CUSTOMER CHASSIS MOUNTING. (USE M4 MOUNTING SCREW.)
 - C: MODEL NAME, NOMINAL INPUT VOLTAGE, NOMINAL OUTPUT VOLTAGE, MAXIMUM OUTPUT CURRENT, PEAK OUTPUT CURRENT AND COUNTRY OF MANUFACTURE ARE SHOWN HERE IN ACCORDANCE WITH THE SPECIFICATIONS.
 - D: FG IS FOR SAFETY GROUND CONNECTION.

Outline Drawing

[ZWS150PAF (/S : Horizontal terminal)]

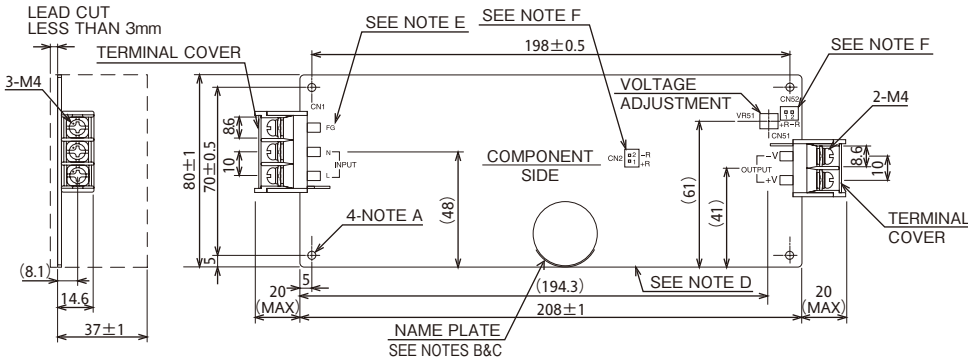

NOTES:

- A: THE $4-\phi 3.5$ HOLES ARE FOR CUSTOMER'S CHASSIS MOUNTING HOLES. ALL MUST BE SCREWED IN ORDER TO CONFORM THE VIBRATION SPEC.
- B: MODEL NAME, INPUT VOLTAGE RANGE, NOMINAL OUTPUT VOLTAGE, MAXIMUM OUTPUT CURRENT ARE SHOWN HERE IN ACCORDANCE WITH THE SPECIFICATIONS.
- C: COUNTRY OF MANUFACTURE WILL BE SHOWN HERE.
- D: TO KEEP THE DISTANCE MORE THAN 4mm BETWEEN PC-BOARD EDGE AND CUSTOMER'S CHASSIS.
- E: FG IS FOR SAFETY GROUND CONNECTION.
- F: REMOTE ON/OFF CONTROL CONNECTOR (CN2, CN52) : B2B-XH-AM (J.S.T.) *CN2 IS NORMALLY SHORTED BY JM-2W-96 (J.S.T.)
- MATCHING HOUSING : XHP-2 (J.S.T.)
- MATCHING TERMINAL : BXH-001T-P0.6 (J.S.T.) OR SXH-001T-P0.6 (J.S.T.)
- HAND CRIMPING TOOL : YC-110R OR YRS-110 MANUFACTURER : J.S.T.

(unit : mm)

[ZWS150PAF (/SL : Horizontal terminal, with L-shape metal plate)]

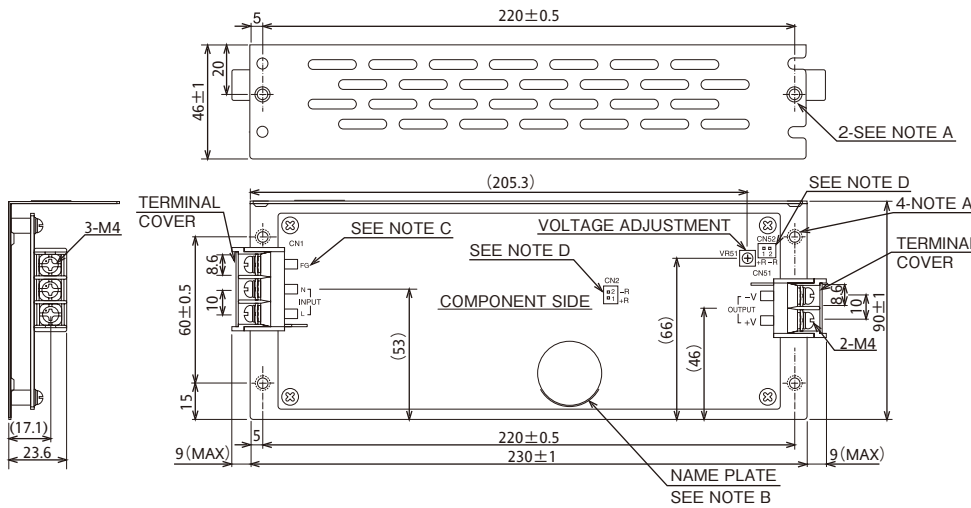

NOTES:

- A: M4 EMBOSSED TAPPED & COUNTERSUNK HOLES (6) ARE FOR CUSTOMER CHASSIS MOUNTING. SCREW MUST NOT PROTRUDE INTO POWER SUPPLY BY MORE THAN 6mm.
- B: MODEL NAME, NOMINAL INPUT VOLTAGE, NOMINAL OUTPUT VOLTAGE, MAXIMUM OUTPUT CURRENT, PEAK OUTPUT CURRENT AND COUNTRY OF MANUFACTURE ARE SHOWN HERE IN ACCORDANCE WITH THE SPECIFICATIONS.
- C: FG IS FOR SAFETY GROUND CONNECTION.
- D: REMOTE ON/OFF CONTROL CONNECTOR (CN2, CN52) : B2B-XH-AM (J.S.T.) *CN2 IS NORMALLY SHORTED BY JM-2W-96 (J.S.T.)
- MATCHING HOUSING : XHP-2 (J.S.T.)
- MATCHING TERMINAL : BXH-001T-P0.6 (J.S.T.) OR SXH-001T-P0.6 (J.S.T.)
- HAND CRIMPING TOOL : YC-110R OR YRS-110 MANUFACTURER : J.S.T.

(unit : mm)

[ZWS150PAF (/SA : Horizontal terminal, with cover)]

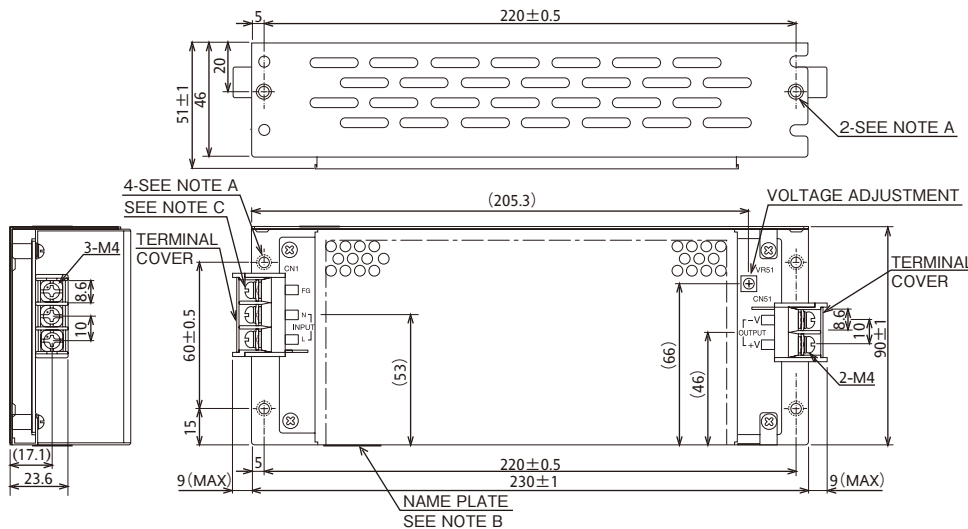

NOTES:

- A: M4 EMBOSSED TAPPED & COUNTERSUNK HOLES (6) ARE FOR CUSTOMER CHASSIS MOUNTING. SCREW MUST NOT PROTRUDE INTO POWER SUPPLY BY MORE THAN 6mm.
- B: MODEL NAME, NOMINAL INPUT VOLTAGE, NOMINAL OUTPUT VOLTAGE, MAXIMUM OUTPUT CURRENT, PEAK OUTPUT CURRENT AND COUNTRY OF MANUFACTURE ARE SHOWN HERE IN ACCORDANCE WITH THE SPECIFICATIONS.
- C: FG IS FOR SAFETY GROUND CONNECTION.

(unit : mm)

Output Derating

[ZWS150PAF]

Recommended standard mounting method is (A).

(B), (C), (D) and (E) are also possible. Mounting (F), (G), (H) and (I) are prohibited.

Please do not use (F), where the PCB will be on the top side and heat will be trapped inside the unit.

In the following derating curve, average load (%) is percent of maximum output load (both maximum output current and maximum output power in specification.)

Do not exceed the load derating.

●PCB type

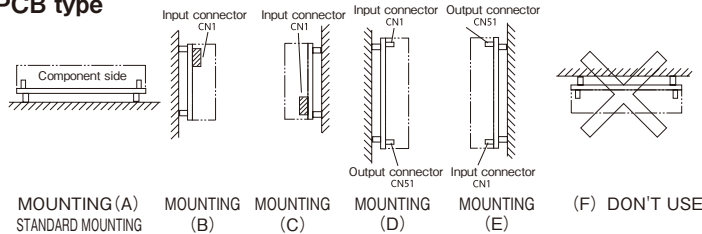

●With chassis & cover type

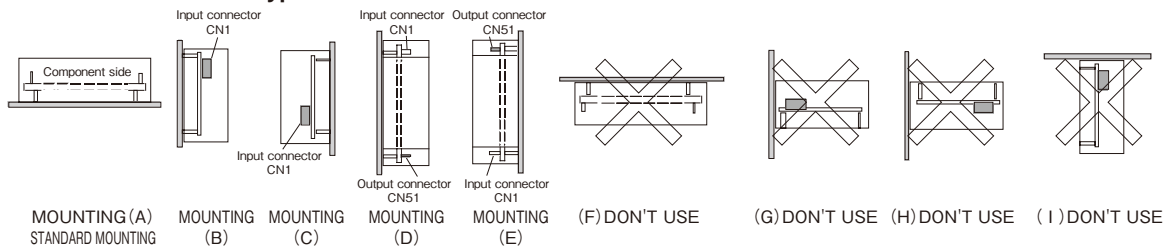

*COOLING : CONVECTION COOLING

OUTPUT DERATING CURVE (PCB type and with chassis type)

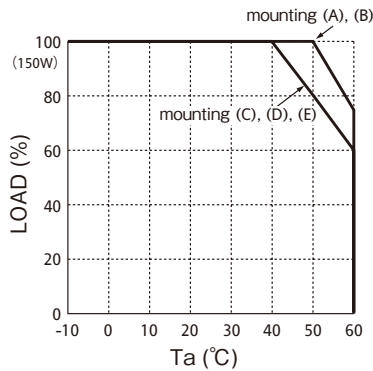

*COOLING : FORCED AIR COOLING

OUTPUT DERATING CURVE (PCB type and with chassis type)

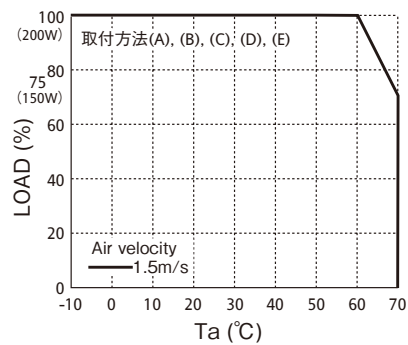

*COOLING : CONVECTION COOLING

OUTPUT DERATING CURVE (With chassis and cover type)

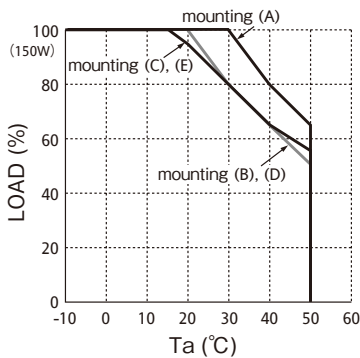

*COOLING : FORCED AIR COOLING

OUTPUT DERATING CURVE (With chassis and cover type)

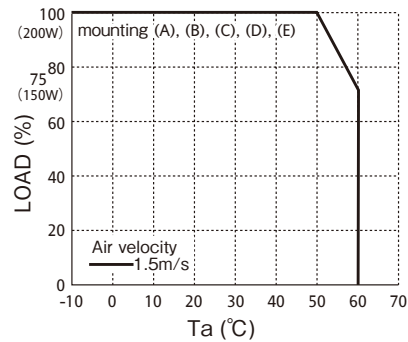

Recommended Minimum Air Velocity : 0.7m/s (Measured at component side of PCB, Air must flow through component side.)

As a reference for forced air cooling, let air flow so that the transformer T1 core temperature is lower than 85°C.

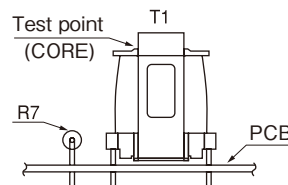

ZWS240PAF (Convection Cooling) Specifications

ITEMS/UNITS		MODEL	ZWS240PAF-24/J	ZWS240PAF-36/J	ZWS240PAF-48/J
Input	Voltage Range	(*3) V	AC85 - 265 or DC120 - 370		
	Frequency	(*3) Hz	47-63		
	Power Factor (100/200VAC)(typ)	(*2)	0.99 / 0.95		
	Efficiency (typ)	(*2) %	82		
	Current (100/200VAC)(typ)	(*2) A	3.2 / 1.6		
	Inrush Current (100/200VAC)(typ)	(*4) A	14 / 28 at, Ta=25°C, cold start		
	Leakage Current	(*10) mA	0.5 Max, 0.1 (typ) at 100VAC / 0.22 (typ) at 230VAC		
Output	Nominal Voltage	VDC	24	36	48
	Maximum Current	A	10	6.7	5
	Maximum Peak Current	(*1) A	20	13.3	10
	Maximum Power	W	240	241.2	240
	Maximum Peak Power	(*1) W	480	478.8	480
	Maximum Line Regulation	(*5)(*6) mV	96	144	192
	Maximum Load Regulation	(*5)(*7) mV	192	288	384
	Temperature Coefficient		Less than 0.02%/°C		
	Maximum Ripple & Noise (0<Ta<60°C) (*5)	mVp-p	240	360	480
	Maximum Ripple & Noise (-10<Ta<0°C) (*5)	mVp-p	360	540	720
	Hold-up Time (typ)	(*2) ms	20		
	Voltage Adjustable Range	VDC	21.6 - 28.8	32.4 - 41.4	43.2 - 52.8
	Function	Over Current Protection	(*8) A	> 20.5	> 13.7
Over Voltage Protection		(*9) VDC	30.0 - 35.0	43.2 - 50.4	55.2 - 64.8
Remote ON/OFF Control			Possible		
Parallel Operation			-		
Series Operation			Possible		
Environment	Operating Temperature	(*11) °C	- 10 to + 60 Convection: -10 to +45 (100%); 60 (60%)		
	Storage Temperature	°C	- 30 to +85		
	Operating Humidity	%RH	30 - 90 (No dewdrop)		
	Storage Humidity	%RH	10 - 95 (No dewdrop)		
	Vibration		At no operating, 10 - 55Hz (sweep for 1min) 19.6m/s² constant, X, Y, Z 1hour each		
	Shock (In package)		Less than 196.1m/s²		
	Cooling		Convection cooling		
Isolation	Withstand Voltage		Input - Output : 3.0kVAC (20mA), Input - FG : 2.0kVAC (20mA) Output - FG : 500VAC (100mA) for 1min.		
	Isolation Resistance		More than 100MΩ at Ta=25°C and 70%RH, Output - FG : 500VDC		
Standards	Safety Standards		Approved by UL60950-1, CSA C22.2 No.60950-1, EN60950-1, Built to meet DENAN		
	PFHC		Built to meet EN61000-3-2		
	EMI	(*12)	Built to meet VCCI-B, FCC-Class B, EN55011/EN55022-B		
Mechanical	Immunity		Built to meet EN61000-4-2,-3,-4,-5,-6,-8,-11		
	Weight (typ)	g	750		
	Size (W x H x D)	mm	95 x 45 x 222 (Refer to outline drawing)		

(*1) Operating period at peak output current is less than 10 sec. (Duty ≤ 0.35)
(Average output power and current is less than maximum output power and current.)
For peak load derating method, please refer to instruction manual for details.

(*2) At 100/200VAC and maximum output power, Ta=25°C.

(*3) For cases where conformance to various safety specs (UL, CSA, EN) are required, to be described as 100-240VAC, 50/60Hz on name plate.

(*4) Not applicable for the in-rush current to noise filter for less than 0.2ms.

(*5) Please refer to Fig A for measurement of line & load regulation and output ripple voltage.
(Measure with JEITA RC-9131 probe.)

(*6) 85-265VAC, constant load.

(*7) No load - full load (maximum power), constant input voltage.

(*8) Constant current limit with automatic recovery. Avoid to operate at overload or dead short for more than 30 seconds.

(*9) OVP circuit will shutdown output, manual reset. (line recycle)

(*10) Measured by each measuring method of UL, CSA, EN and DENAN (at 60Hz).

(*11) At standard mounting method, Fig B.
- Load(%) is percent of maximum output load (Item 2 and 5), do not exceed derating in both maximum output current and power.
- For other mountings, refer to derating curve.
- When forced air cooling, refer to derating curve.

(*12) 85 - 265VAC, No load - full load, constant load.

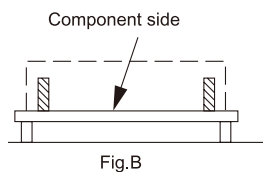
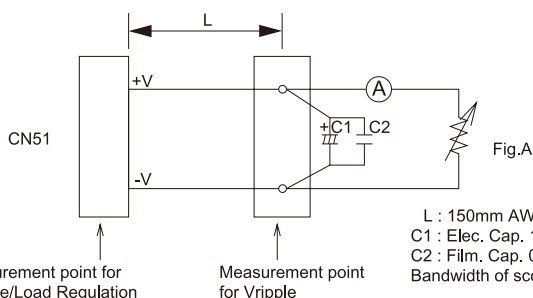

Recommended EMC Filter



RSEL-2006W
Please refer to "TDK-Lambda EMC Filters" catalog.

ZWS240PAF (Forced Air Cooling) Specifications

ITEMS		MODEL	ZWS240PAF-24	ZWS240PAF-36	ZWS240PAF-48
Input	Voltage Range	(*3) V	AC85 - 265 or DC120 - 370		
	Frequency	(*3) HZ	47-63		
	Current (100/200VAC)(typ)	(*4) A	4.0 / 2.0		
Output	Nominal Voltage	VDC	24	36	48
	Maximum Current	(*1) A	12.5	8.4	6.3
	Maximum Peak Current	(*2) A	20	13.3	10
	Maximum Power	(*1) W	300	302.4	
	Maximum Peak Power	(*2) W	480	478.8	480
	Hold-Up Time (typ)	(*4) ms	16		
Environment	Operating Temperature	(*5)(*6) °C	- 10 to + 70 -10 to +60 (100%); 70 (70%)		
	Cooling	(*1)	Forced air cooling		
Standards	EMI	(*7)	Built to meet VCCI-A, FCC-Class A, EN55011/EN55022-A		

(*1) Forced air cooling with air velocity more than 1.5m/s (measured at component side of PCB, air must flow through component side).

(*2) Operating period at peak output current is less than 10 sec. (Duty \leq 0.35)
(Average output power and current is less than maximum output power and current.)
For peak load derating method, please refer to instruction manual for details.

(*3) For cases where conformance to various safety specs (UL, CSA, EN) are required, to be described as 100 - 240VAC, 50/60Hz on name plate.

(*4) At 100/200VAC and maximum output power, Ta = 25°C.

(*5) At standard mounting method A, and other mountings B, C, D, E.
- Load(%) is percent of maximum output load, do not exceed derating in both maximum output current and power.

(*6) Output derating for cold start up at Ta = - 10°C for input voltage : 85VAC 80%, 90VAC 86.7%, 100-265VAC 100%.
No output derating for input voltage is required after start up for one second.

(*7) 85 - 265 VAC, full load.

Recommended EMC Filter

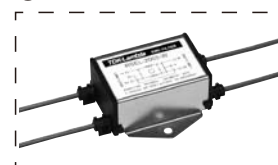

RSEL-2006W

Please refer to "TDK-Lambda EMC Filters" catalog.

Outline Drawing

[ZWS240PAF (/T : Vertical terminal)]

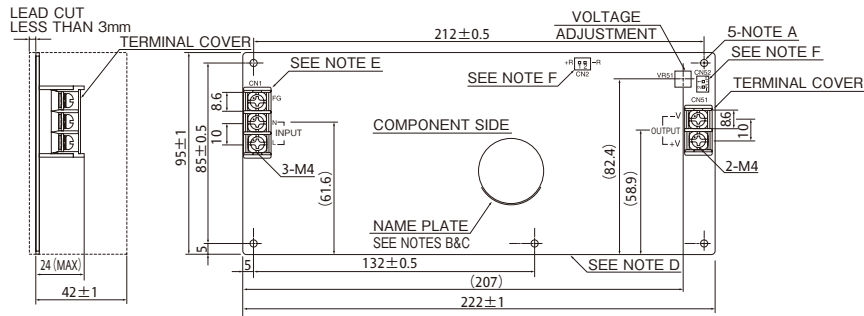

(unit : mm)

NOTES:

- A. THE 5-φ3.5 HOLES ARE CUSTOMER'S CHASSIS MOUNTING HOLES. ALL MUST BE SCREWED IN ORDER TO CONFORM TO THE VIBRATION SPEC.
- B. MODEL NAME, INPUT VOLTAGE RANGE, NOMINAL OUTPUT VOLTAGE, MAXIMUM OUTPUT CURRENT ARE SHOWN HERE IN ACCORDANCE WITH THE SPECIFICATIONS.
- C. COUNTRY OF MANUFACTURE WILL BE SHOWN HERE.
- D. TO KEEP THE DISTANCE MORE THAN 4mm BETWEEN PC-BOARD EDGE AND

- E. FG IS FOR SAFETY GROUND CONNECTION.
- F. REMOTE ON/OFF CONTROL CONNECTOR (CN2, CN52) : B2B-XH-AM (J.S.T.)
*CN2 IS NORMALLY SHORTED BY JM-2W-96(J.S.T.)
MATCHING HOUSING : XHP-2 (J.S.T.)
MATCHING TERMINAL : BXH-001T-P0.6 (J.S.T.) OR SXH-001T-P0.6 (J.S.T.)
HAND CRIMPING TOOL : YC-110R OR YRS-110 MANUFACTURER : J.S.T.

[ZWS240PAF (/TL : Vertical terminal, with L-shape metal plate)]

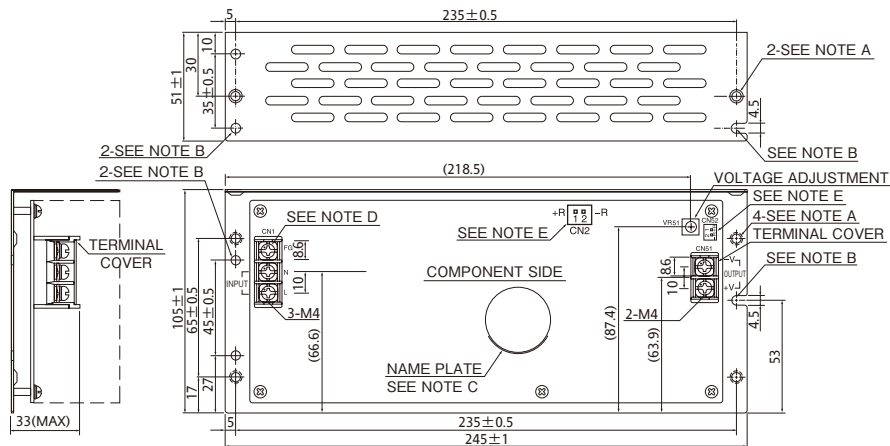

(unit : mm)

NOTES

- A: M4 EMBOSSED TAPPED & COUNTERSUNK HOLES (6) ARE FOR CUSTOMER CHASSIS MOUNTING. SCREW MUST NOT PROTRUDE INTO POWER SUPPLY BY MORE THAN 6mm
- B: φ4.5 HOLES (4) AND R2.25 SLOT HOLES (2) ARE FOR CUSTOMER CHASSIS MOUNTING. (USE M4 MOUNTING SCREW.)
- C: MODEL NAME, INPUT VOLTAGE RANGE, NOMINAL OUTPUT VOLTAGE, MAXIMUM OUTPUT CURRENT, AND COUNTRY OF MANUFACTURE ARE SHOWN HERE IN AC-

- CORDANCE WITH THE SPECIFICATIONS.
- D: FG IS FOR SAFETY GROUND CONNECTION.
- E: REMOTE ON/OFF CONTROL CONNECTOR (CN2, CN52) : B2B-XH-AM (J.S.T.)
*CN2 IS NORMALLY SHORTED BY JM-2W-96(J.S.T.)
MATCHING HOUSING : XHP-2 (J.S.T.)
MATCHING TERMINAL : BXH-001T-P0.6 (J.S.T.) OR SXH-001T-P0.6 (J.S.T.)
HAND CRIMPING TOOL : YC-110R OR YRS-110 MANUFACTURER : J.S.T.

[ZWS240PAF (/TA : Vertical terminal, with cover)]

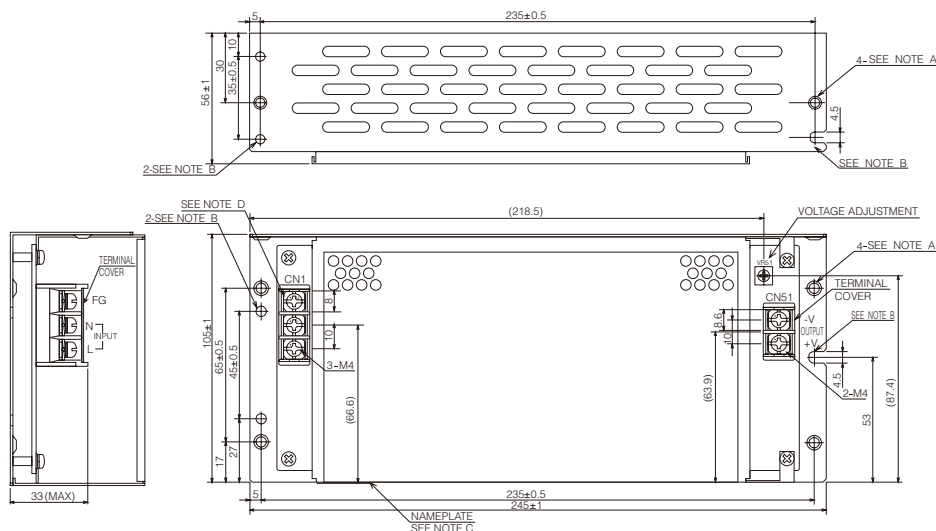

(unit : mm)

NOTES

- A: M4 EMBOSSED TAPPED & COUNTERSUNK HOLES (6) ARE FOR CUSTOMER CHASSIS MOUNTING. SCREW MUST NOT PROTRUDE INTO POWER SUPPLY BY MORE THAN 6mm.
- B: φ4.5 HOLES (4) AND R2.25 SLOT HOLES (2) ARE FOR CUSTOMER CHASSIS

- MOUNTING. (USE M4 MOUNTING SCREW.)
- C: MODEL NAME, INPUT VOLTAGE RANGE, NOMINAL OUTPUT VOLTAGE, MAXIMUM OUTPUT CURRENT, AND COUNTRY OF MANUFACTURE ARE SHOWN HERE IN ACCORDANCE WITH THE SPECIFICATIONS.
- D: FG IS FOR SAFETY GROUND CONNECTION.

Outline Drawing

[ZWS240PAF (/S : Horizontal terminal)]

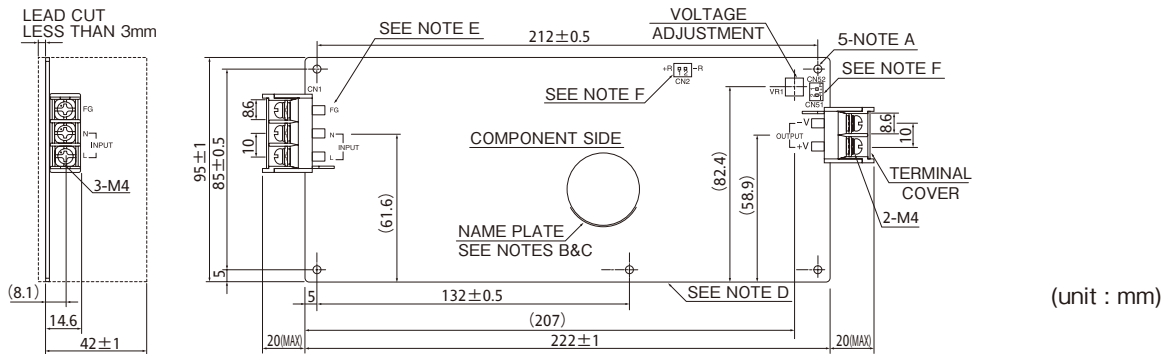

NOTES

- A. THE 5-φ3.5 HOLES ARE CUSTOMER'S CHASSIS MOUNTING HOLES. ALL MUST BE SCREWED IN ORDER TO CONFORM THE VIBRATION SPEC.
- B. MODEL NAME, INPUT VOLTAGE RANGE, NOMINAL OUTPUT VOLTAGE, MAXIMUM OUTPUT CURRENT ARE SHOWN HERE IN ACCORDANCE WITH THE SPECIFICATIONS.
- C. COUNTRY OF MANUFACTURE WILL BE SHOWN HERE.

- D. TO KEEP THE DISTANCE MORE THAN 4m/m BETWEEN PC-BOARD EDGE AND CUSTOMER'S CHASSIS.
- E. FG IS FOR SAFETY GROUND CONNECTION.
- F. REMOTE ON/OFF CONTROL CONNECTOR (CN2, CN52) : B2B-XH-AM (J.S.T.)
 *CN2 IS NORMALLY SHORTED BY JM-2W-96(J.S.T.)
 MATCHING HOUSING : XHP-2 (J.S.T.)
 MATCHING TERMINAL : BXH-001T-P0.6 (J.S.T.) OR SXH-001T-P0.6 (J.S.T.)
 HAND CRIMPING TOOL : YC-110R OR YRS-110 MANUFACTURER : J.S.T.

[ZWS240PAF (/SL : Horizontal terminal, with L-shape metal plate)]

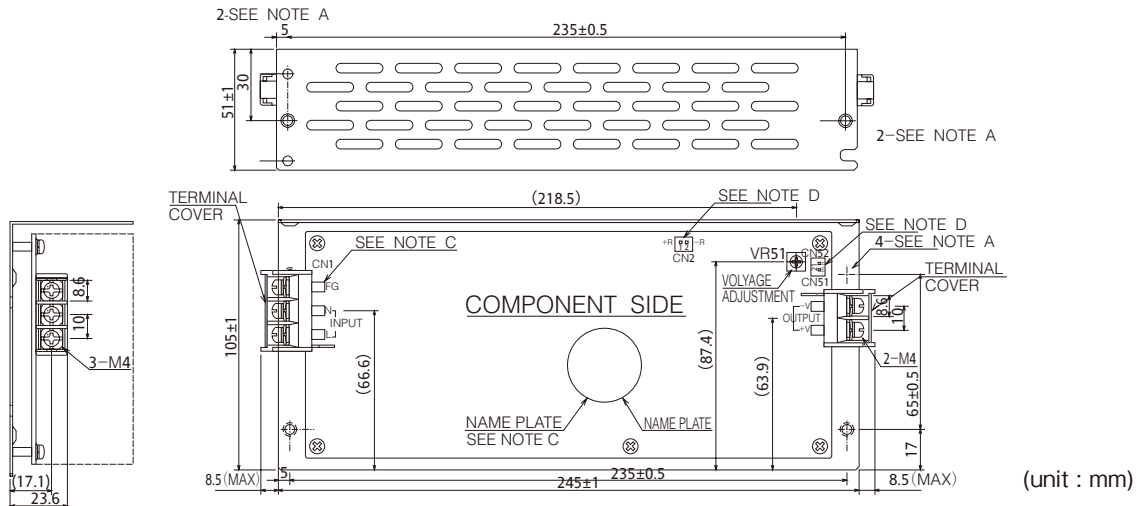

NOTES

- A. M4 EMBOSSED TAPPED & COUNTERSUNK HOLES (6) ARE FOR CUSTOMER CHASSIS MOUNTING. SCREW MUST NOT PROTRUDE INTO POWER SUPPLY BY MORE THAN 6mm.
- B. MODEL NAME, INPUT VOLTAGE RANGE, NOMINAL OUTPUT VOLTAGE, MAXIMUM OUTPUT CURRENT, AND COUNTRY OF MANUFACTURE ARE SHOWN HERE IN ACCORDANCE WITH THE SPECIFICATIONS.

- C. FG IS FOR SAFETY GROUND CONNECTION.
- D. REMOTE ON/OFF CONTROL CONNECTOR (CN2,CN52) : B2B-XH-AM (J.S.T.)
 *CN2 IS NORMALLY SHORTED BY JM-2W-96(J.S.T.)
 MATCHING HOUSING : XHP-2 (J.S.T.)
 MATCHING TERMINAL : BXH-001T-P0.6 (J.S.T.) OR SXH-001T-P0.6 (J.S.T.)
 HAND CRIMPING TOOL : YC-110R OR YRS-110 MANUFACTURER : J.S.T.

[ZWS240PAF (/SA : Horizontal terminal, with cover)]

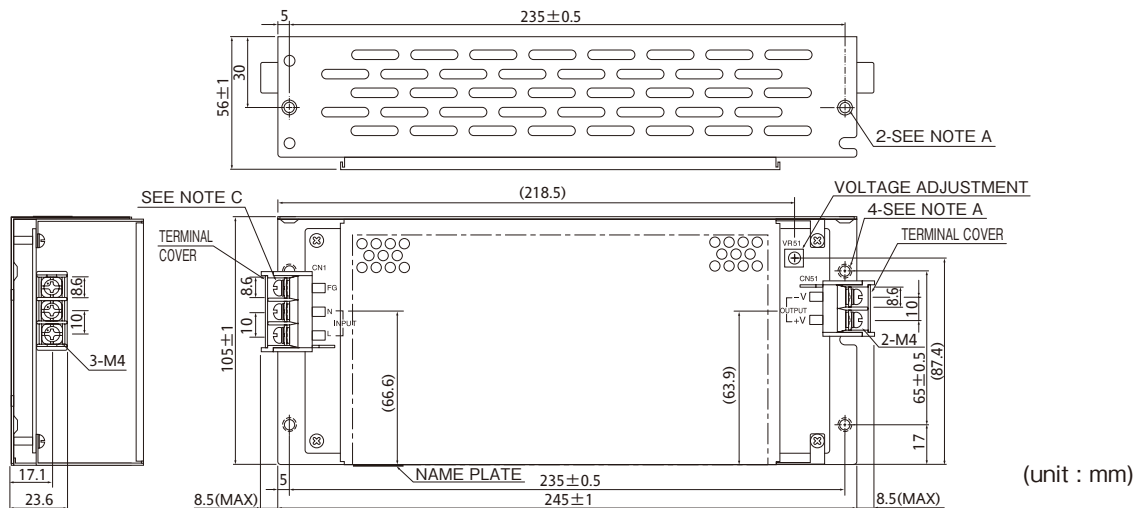

NOTES

- A. M4 EMBOSSED TAPPED & COUNTERSUNK HOLES (6) ARE FOR CUSTOMER CHASSIS MOUNTING. SCREW MUST NOT PROTRUDE INTO POWER SUPPLY BY MORE THAN 6mm.

- B. MODEL NAME, INPUT VOLTAGE RANGE, NOMINAL OUTPUT VOLTAGE, MAXIMUM OUTPUT CURRENT, AND COUNTRY OF MANUFACTURE ARE SHOWN HERE IN ACCORDANCE WITH THE SPECIFICATIONS.
- C. FG IS FOR SAFETY GROUND CONNECTION.

Output Derating

[ZWS240PAF]

Recommended standard mounting method is (A).

(B), (C), (D) and (E) are also possible. Mounting (F), (G), (H) and (I) are prohibited.

Please do not use (F), where the PCB will be on the top side and heat will be trapped inside the unit.

In the following derating curve, average load (%) is percent of maximum output load (both maximum output current and maximum output power in specification.) Do not exceed the load derating.

● **PCB type**

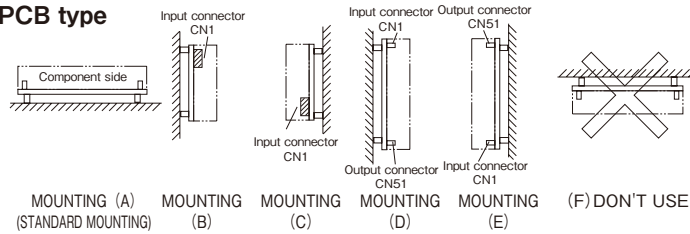

● **With chassis & cover type**

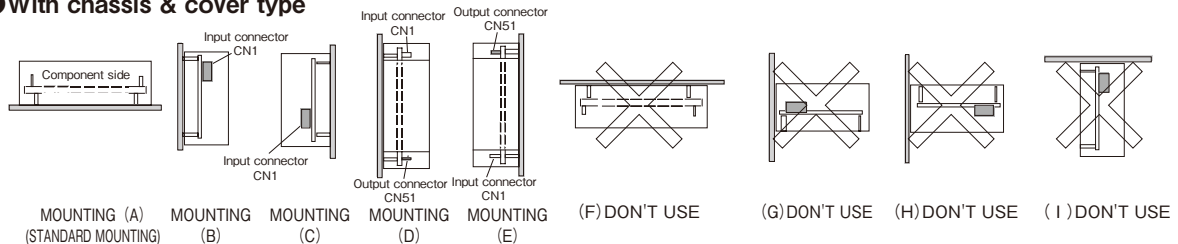

* **COOLING: CONVECTION COOLING**

OUTPUT DERATING CURVE (PCB type and with chassis)

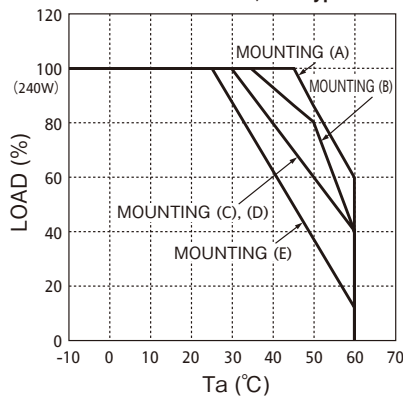

* **COOLING: FORCED AIR COOLING**

OUTPUT DERATING CURVE (PCB type and with chassis)

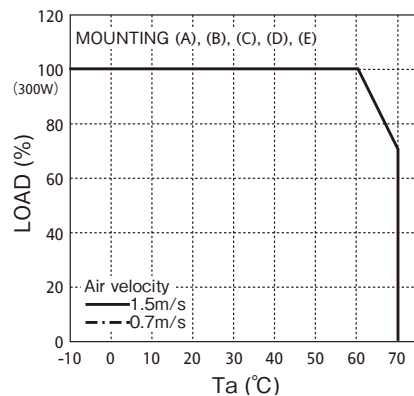

* **COOLING: CONVECTION COOLING**

OUTPUT DERATING CURVE (With cover)

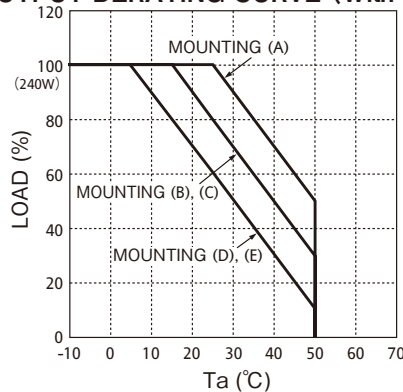

* **COOLING: FORCED AIR COOLING**

OUTPUT DERATING CURVE (With cover)

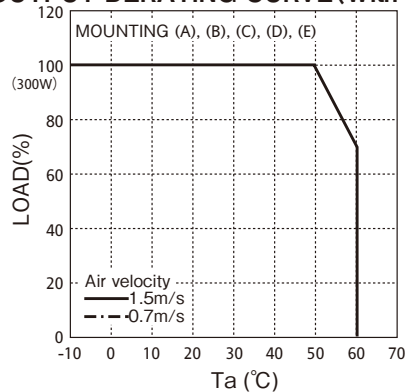

Recommended Minimum Air Velocity: 0.7m/s (Measured at component side of PCB, Air must flow through component side.)

As a reference for forced air cooling, let air flow so that the transformer T1 core temperature is lower than 85°C.

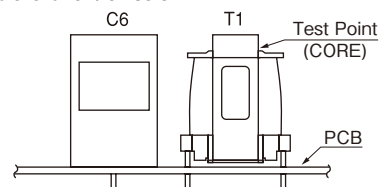

Block Diagram

[ZWS150PAF, ZWS240PAF]

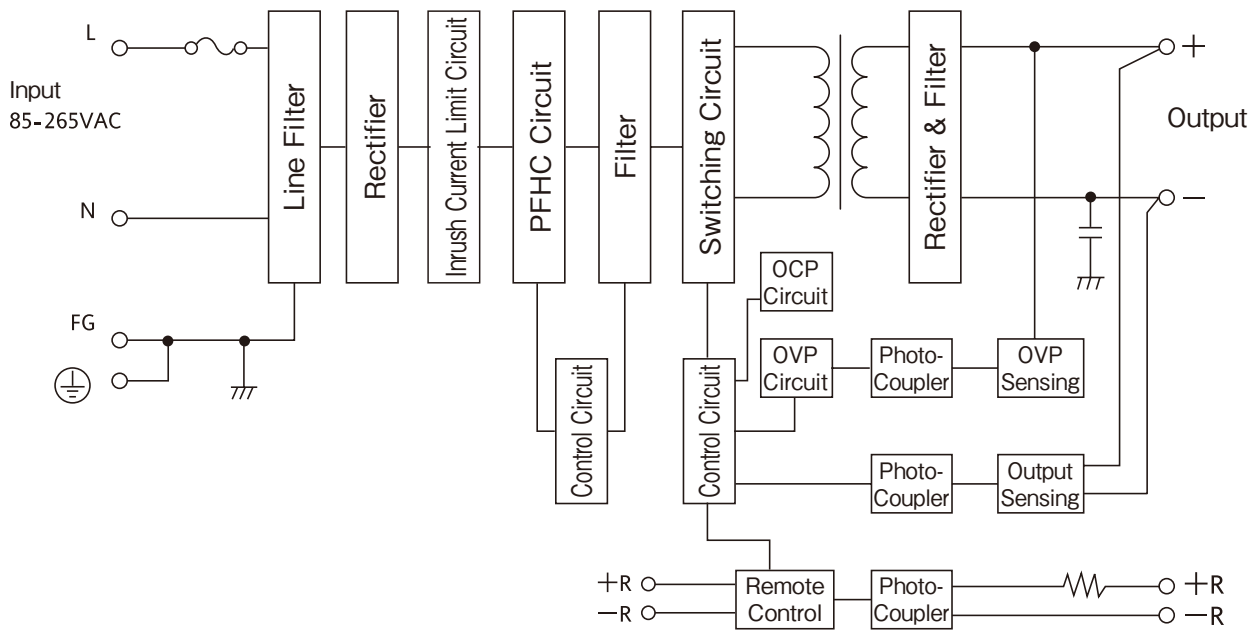

- Circuit mode and switching frequency
Switching circuit : Single-ended forward topology (130kHz)
PFHC circuit : Active filter (90kHz)
- Fuse rating···ZWS150PAF : 5A, ZWS240PAF : 6.3A

Circuit for Measuring Performances (ZWS150PAF, ZWS240PAF)

ℓ : 150mm
 Wire material: AWG#18
 C1: Electrolytic capacitor
 100μF
 C2: Film capacitor
 0.1μF

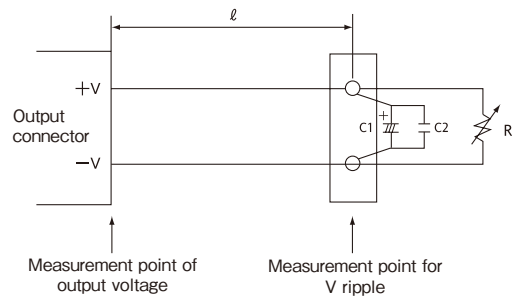

ZWS150PAF Series Instruction Manual

BEFORE USING THE POWER SUPPLY UNIT

Pay attention to all warnings and cautions before using the unit. Incorrect usage could lead to an electric shock, damage to the unit or a fire hazard.

⚠ WARNING and CAUTION

- Do not modify.
- Do not touch the internal components, they may have high voltage or high temperature. You may get electric shock or burned.
- When the unit is operating, keep your hands and face away from it, you may get injured by an accident.
- This power supply is primarily designed and manufactured to be used and enclosed in other equipment. Stick the WARNING label for users on the system equipment and describe the notice in the instruction manual.

- Never operate the unit under over current or shorted conditions for 30 seconds or more and out of input voltage range in specification which could result in damage or insulation failure or smoking or burning.
- Confirm connections to input/output terminals are correct as indicated in the instruction manual.
- This power supply is PC board type unit. Please hold the board edge while mounting, and do not touch the component side. Please lift the power supply with a spacer when mounting the power supply on any surface.
- Do not drop or apply shock to power supply unit.

Note : CE MARKING

CE Marking, when applied to a product covered by this handbook, indicates compliance with the low voltage directive (73/23/EEC) as modified by the CE Marking Directive (93/68/EEC) which complies with EN60950.

1. Terminal Explanation

1 ZWS150PAF

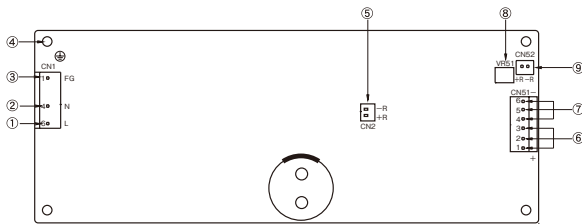

- ① L: AC Input terminal (pin 6 of CN1)
Live line (fuse in line)
- ② N: AC input terminal (pin 4 of CN1)
Neutral line
- ③ FG: Input terminal FG (pin 1 of CN1)
Safety earth (Frame Ground)
Connect to safety ground of apparatus or equipment.
- ④ FG: Frame Ground (Connected to pin 1 of CN1)
Must be connected to electrically safe ground of apparatus or equipment by electrically conductive spacers. The mounting surface of the spacer should be within MAX 8mm.
- ⑤ CN2: ON/OFF control terminal (primary circuit) See NOTE A.
- ⑥ +: + Output terminal
- ⑦ -: - Output terminal
- ⑧ V.ADJ: Output voltage adjust trimmer (VR51) The output voltage rises when a trimmer is turned clockwise.
- ⑨ CN52: ON/OFF control terminal (secondary circuit)
(For power supply output on and off control with an external signal.)
See NOTE A.

NOTE A: For cover & chassis type (model: ZWS150PAF/A), remote ON/OFF control cannot be used.

● Input & Output connector (MOLEX) (also for option model /L, /A)

	Connector	Housing	Terminal Pin
Input (CN1)	5414-30B	5239-06 or 2139-06 or 3069-06	5167PBTL
Output (CN51)	5273-06A	5239-06 or 2139-06 or 3069-06	5167PBTL

* Output current of each connector pin must be less than 5A.
* Hand crimping tooling: JHTR2445A (MOLEX)

● Connector for Remote ON/OFF control: CN2, CN52 (J.S.T)

Connector	Housing	Terminal Pin
B2B-XH-AM	XHP-2	BXH-001T-P0.6 or SXH-001T-P0.6

* CN2 is normally shorted by JM-2W-96 (J.S.T)
* Hand crimping tool: YC-110R (J.S.T) or YRS-110 (J.S.T)

2 ZWS150PAF/J

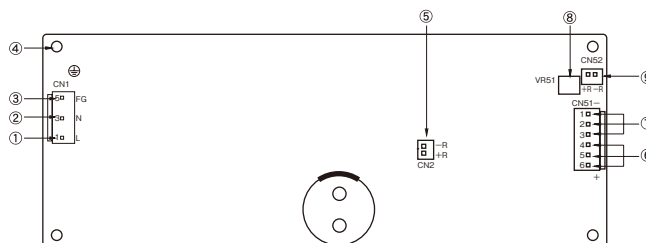

- ① L: AC Input terminal (pin 1 of CN1)
Live line (fuse in line)
- ② N: AC input terminal (pin 3 of CN1)
Neutral line
- ③ FG: Input terminal FG (pin 5 of CN1)
Safety earth (Frame Ground)
Connect to safety ground of apparatus or equipment.
- ④ FG: Frame Ground (Connected to pin 5 of CN1)
Must be connected to electrically safe ground of apparatus or equipment by electrically conductive spacers. The mounting surface of the spacer should be within MAX 8mm.
- ⑤ CN2: ON/OFF control terminal (primary circuit)
See NOTE A.
- ⑥ +: + Output terminal
- ⑦ -: - Output terminal
- ⑧ V.ADJ: Output voltage adjust trimmer (VR51)
The output voltage rises when a trimmer is turned clockwise.
- ⑨ CN52: ON/OFF control terminal (secondary circuit)
(For power supply output on and off control with an external signal.)
See NOTE A.

NOTE A: For cover & chassis type (model: ZWS150PAF/JA), remote ON/OFF control cannot be used.

● Input & output connector (J.S.T) (also for option model /JL, /JA)

	Connector	Housing	Terminal Pin
Input (CN1)	B3P-5-VH	VHR-5N	SVH-21T-P1.1
Output (CN51)	B6P-VH	VHR-6N	SVH-21T-P1.1

* Output current of each connector pin must be less than 5A.
* Hand crimping tool: YC-160R (J.S.T)

● Connector for Remote ON/OFF control: CN2, CN52 (J.S.T)

Connector	Housing	Terminal Pin
B2B-XH-AM	XHP-2	BXH-001T-P0.6 or SXH-001T-P0.6

* CN2 is normally shorted by JM-2W-96 (J.S.T).
* Hand crimping tool: YC-110R (J.S.T) or YRS-110 (J.S.T)

3 ZWS150PAF/T

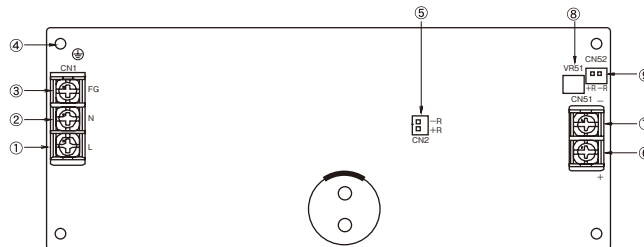

- ① L: AC Input terminal L (M4 screw)
Live line (fuse in line)
- ② N: AC input terminal N (M4 screw)
Neutral line
- ③ FG: Input terminal FG (M4 screw)
Safety earth (Frame Ground)
Connect to safety ground of apparatus or equipment.
- ④ FG: Frame Ground
Must be connected to electrically safe ground of apparatus or equipment by electrically conductive spacers. The mounting surface of the spacer should be within MAX 8mm.
- ⑤ CN2: ON/OFF control terminal (primary circuit)
See NOTE A.
- ⑥ +: + Output terminal (M4 screw)
- ⑦ -: - Output terminal (M4 screw)
- ⑧ V.ADJ: Output voltage adjust trimmer (VR51)
The output voltage rises when a trimmer is turned clockwise.
- ⑨ CN52: ON/OFF control terminal (secondary circuit)
(For power supply output on and off control with an external signal.)
See NOTE A.

NOTE A: For cover & chassis type (model: ZWS150PAF/TA), remote ON/OFF control cannot be used.

● Input & output connector (EMUDEN) (also for option model /TL, /TA)

	Connector
Input (CN1)	T6957-A
Output (CN51)	T7094-A

● Connector for Remote ON/OFF control: CN2, CN52 (J.S.T)

Connector	Housing	Terminal Pin
B2B-XH-AM	XHP-2	BXH-001T-P0.6 or SXH-001T-P0.6

* CN2 is normally shorted by JM-2W-96 (J.S.T).
* Hand crimping tool: YC-110R (J.S.T) or YRS-110 (J.S.T)

4 ZWS150PAF/S

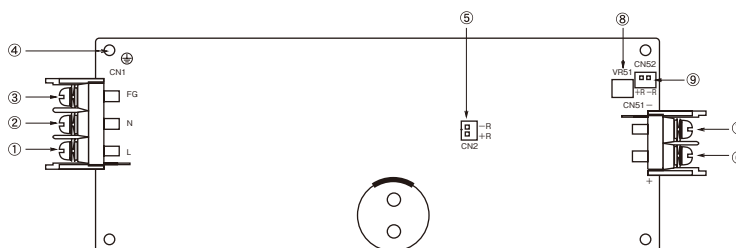

- ① L: AC Input terminal L (M4 screw)
Live line (fuse in line)
- ② N: AC input terminal N (M4 screw)
Neutral line
- ③ FG: Input terminal FG (M4 screw)
Safety earth (Frame Ground)
Connect to safety ground of apparatus or equipment.
- ④ FG: Frame Ground
Must be connected to electrically safe ground of apparatus or equipment by electrically conductive spacers. The mounting surface of the spacer should be within MAX 8mm.
- ⑤ CN2: ON/OFF control terminal (primary circuit)
See NOTE A.
- ⑥ +: + Output terminal (M4 screw)
- ⑦ -: - Output terminal (M4 screw)
- ⑧ V.ADJ: Output voltage adjust trimmer (VR51)
The output voltage rises when a trimmer is turned clockwise.
- ⑨ CN52: ON/OFF control terminal (secondary circuit)
(For power supply output on and off control with an external signal.)
See NOTE A.

● **Input & Output connector (EMUDEN)
(also for option model /SL, /SA)**

	Connector
Input (CN1)	T6969-A
Output (CN51)	T7093-A

● **Connector for Remote ON/OFF control:
CN2, CN52 (J.S.T)**

Connector	Housing	Terminal Pin
B2B-XH-AM	XHP-2	BXH-001T-P0.6 or SXH-001T-P0.6

* CN2 is normally shorted by JM-2W-96 (J.S.T).

* Hand crimping tool: YC-110R (J.S.T) or YRS-110 (J.S.T)

NOTE A: For cover & chassis type (model: ZWS150PAF/SA), remote ON/OFF control cannot be used.

2. Terminal Connecting Method

Pay attention to the input wiring. If it is connected to wrong terminal, the power supply will be damaged.

- Input must be off when making connections.
- Connect FG terminal of input connector and mountable FG to ground terminal of the equipment.
- Output current of each connector pin must be less than 5A.
(Except /T, /S models in which M4 screw is used.)
- The output load line and input line shall be separated and twisted to improve noise sensitivity.

- Remote ON/OFF control lines shall be twisted or use shielded wire.
- Use the input/output connector housing, terminal pin as specified in outline drawing. Also, use recommended crimping tool. Connector housing and terminal pin are not included with this product.
- When connecting or removing connector, do not apply stress to PCB.

ZWS150PAF

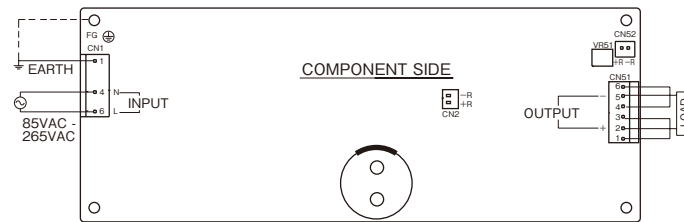

ZWS150PAF/J

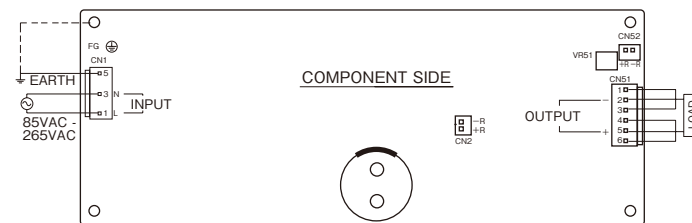

ZWS150PAF/T

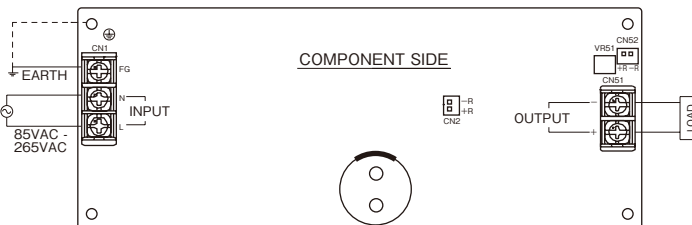

ZWS150PAF/S

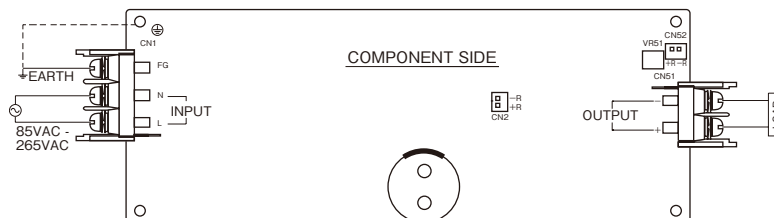

3. Explanation of Functions and Precautions

1 Input Voltage Range

Input voltage range is single phase 85 - 265VAC (47 - 63Hz) or 120 - 370VDC. Input voltage which is out of specification may cause unit damage. For cases where conformance to various safety specs (UL, CSA, EN) are required, input voltage range will be 100 - 240VAC (50/60Hz).

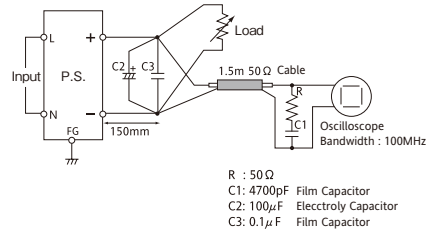

2 Output Voltage Range

V.ADJ trimmer (VR51) that is nearby to output connector is for output voltage adjustment within the range of specifications. To turn the trimmer clockwise, the output voltage will be increased. Note over voltage protection (OVP) function may trigger if the output voltage is increased excessively.

3 Inrush Current

This series uses power thermistor to protect the circuit from inrush current. Please carefully select input switch and fuse in cases of the high temperature and the power re-input.

4 Over Voltage Protection (OVP)

The OVP function (inverter shut down method, manual reset type) is provided. OVP function operates within the range of OVP specification. When OVP triggers, the output will be shut down. The input shall be removed for a few minutes, and then re-input for recovery of the output. OVP setting is fixed and not to be adjusted externally.

5 Over Current Protection (OCP)

Constant current limiting, automatic recovery. OCP function operates when the output current exceeds OCP specification. The output will be automatically recovered when the overload condition is cancelled. Do not operate overload or dead short conditions for more than 30 seconds, which could result in damage.

6 Over Temperature Protection (OTP)

For /OTP, /JOTP, /TOTP, /SOTP models, OTP circuit is built into the power supply to prevent power supply from damage when ambient temperature over the specification.

7 Output Ripple & Noise

The standard specification for maximum ripple value is measured according to measurement circuit specified by JEITA-RC9131. When load lines are longer, ripple becomes larger. In this case, electrolytic capacitor, film capacitor, etc. might be necessary to use across the load terminal. The output ripple cannot be measured accurately if the probe ground lead of oscilloscope is too long.

8 Series Operation

For series operation, either method (A) or (B) is possible.

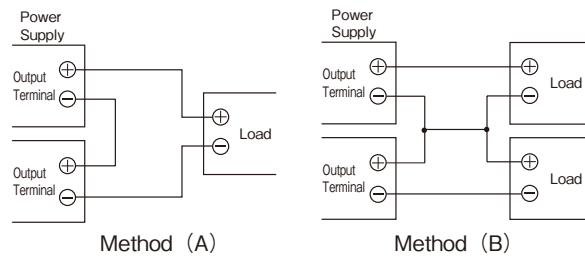

9 Parallel Operation

(A) To increase the output current is not possible.

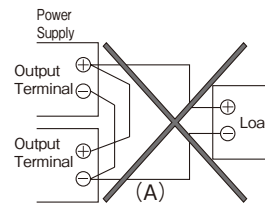

(B) To use as back-up power supply

1. Set power supply output voltage higher by the forward voltage drop (V_F) of diode
2. Adjust the output voltage of each power supply to be the same.
3. Use within the specifications for output voltage and output power.

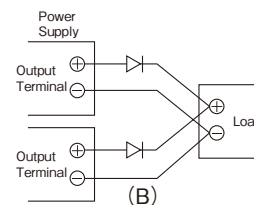

10 Peak Output Current

For ZWS150PAF series, the peak output current should satisfy the conditions below:

- 1) Should not exceed the rated peak current in the specifications. (eg. 12A for ZWS150PAF-24)
- 2) Duty cycle of the peak output current should be $\leq 35\%$, and operating time of peak output current is less than 10 seconds. If the power supply is operated under convection cooling, and ambient exceeds 50°C , the following operating period for peak current is recommended.

Ambient Temperature (°C)	Peak current operating time
- 10 to + 50°C	within 10 seconds
+ 50°C onwards	within 5 seconds

3) The relation between peak output current with maximum average output current is defined as below:

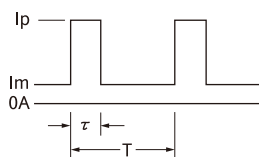

- Ip=Peak output current
- Im=Minimum output current
- D=Duty cycle, τ / T
- τ =Peak output current operating time
- T=Period
- Io=Maximum allowable average output current specifications (Io should be average load after derating at various mounting and ambient temperature)

Formula:

$$ZWS150PAF: 1.4 \times I_o^2 \geq I_p^2 \times D + I_m^2 \times (1-D)$$

Example I : For ZWS150PAF-24 at Ta =60°C, Mounting A, Max Io =4.41A (after 70% Derating)

$$1.4 \times I_o^2 \geq I_p^2 \times D + I_m^2 \times (1-D)$$

(A): In case of Im=0, Ip=12A, D≤18.9%

(B): In case of Im=2A, Ip=12A, D≤16.6%

Example II : Following table illustrate some peak load operation examples for ZWS150PAF-24.

Please note that the actual Io in peak load operation is low .

Max allowable average load after derating by various Mounting and Ta:		Examples of peak load derating, calculated by above formula			Actual Io
Average Load (%)	Io (A)	Ip (A) max	D max	Im (A)	Io (A)
100%	6.3	12	35.0%	2.83	6.04
90%	5.67	12	31.3%	0	3.75
80%	5.04	12	24.7%	0	2.96
70%	4.41	12	18.9%	0	2.27
60%	3.78	12	13.9%	0	1.67
50%	3.15	12	9.7%	0	1.16
40%	2.52	12	6.2%	0	0.74
30%	1.89	12	3.5%	0	0.42
20%	1.26	12	1.5%	0	0.18
10%	0.63	12	0.4%	0	0.05

11 Remote ON/OFF Control

Remote ON/OFF control (CN2, CN52) function is available. Using this function allows the user to turn the output on and off without having to turn the AC input on and off.

Remote ON/OFF control can be used by following 2 modes. However, for cover and chassis type (eg. ZWS150PAF/A, /JA, /TA, /SA) cannot be used.

Using CN2

It is controlled by short or open between +R & -R of CN2. CN2 is provided in the primary circuit for ON/OFF control by means of a switch or other device. When using this connector, which is considered to be electrically connected to the mains input voltage, all the requirements of EN60950 must be met with respect to the connector, wiring and switch etc.

In particular:

- 1) Basic insulation must be provided between the ON/OFF control circuit and earth.
- 2) Reinforced insulation must be provided between the ON/OFF control circuit and any secondary circuit or accessible part.
- 3) Wiring must be routed such that damage to the insulation of the wire or additional sleeving cannot occur.
- 4) The switch must meet requirements for reinforced insulation from the ON/OFF control circuit to actuator/accessible parts.

[CN2] The control mode is shown below.

+R & -R Terminal condition	Output condition
Short	ON
Open	OFF

*Using CN52

At first, remove short piece of CN2.

It is controlled by the voltage applied to +R and -R. This circuit is in the Secondary (output) side of the power supply unit. Do not connect in the Primary (input) side. And this circuit is isolated from the output by a photo-coupler.

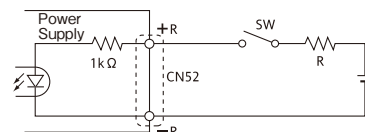

[CN52] The control mode is shown below.

+R & -R terminal condition	Output condition
SW ON (Higher than 4.5V)	ON
SW OFF (Lower than 0.8V)	OFF

External voltage level : E	External resistance : R
4.5 - 12.5VDC	No required
12.5 - 24.5VDC	1.5kΩ

12 Isolation Test

Isolation resistance between output and FG (Chassis) shall be more than 100MΩ at 500VDC. For safety operation, voltage setting of DC isolation tester must be done before the test. Ensure that it is fully discharged after the test.

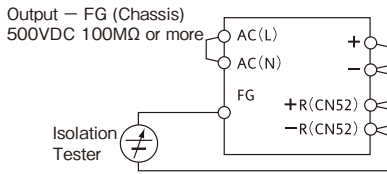

13 Withstand Voltage

This series is designed to withstand 3.0kVAC between input and output, 2.0kVAC between input and FG (Chassis) and 500VAC between output and the FG (Chassis) each for 1 minute. When testing withstand voltage, set current limit of the withstand voltage test equipment to 20mA (Output-FG (Chassis): 100mA). The applied voltage

must be gradually increased from zero to the testing value and then gradually decreased for shut down. When timer is used, the power supply may be damaged by high impulse voltage at timer switch on and off. Connect input and output as follows.

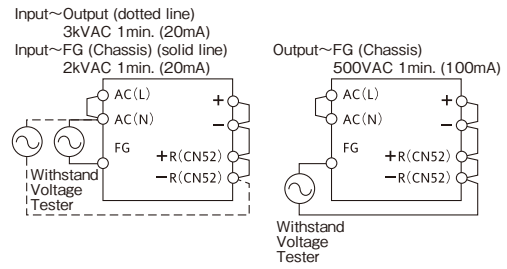

4. Mounting Directions

1 Output Derating according to the Mounting Directions

Recommended standard mounting method is (A). Method (B), (C), (D), (E) are also possible. Mounting (F), (G) are prohibited. Please do not use installation method (F), where the PCB will be on the top side and heat will be trapped inside the unit. Refer to the derating below. In the following derating curve, average load (%) is percent of maximum output load (both maximum output current and maximum output power in specifications). Do not exceed the load deratings.

● PCB type

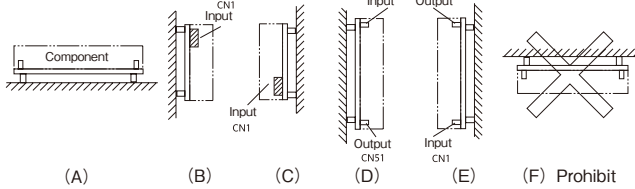

Standard Mounting

● With chassis, with chassis&cover type

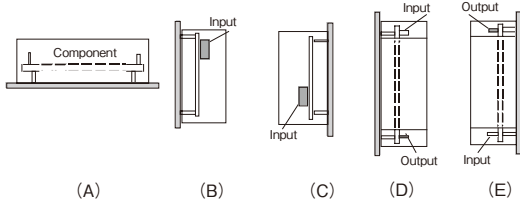

Standard Mounting

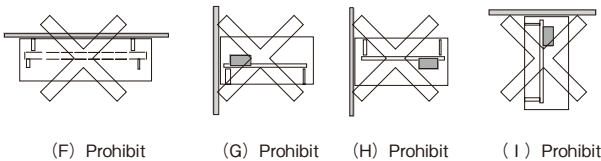

Output Derating

● Convection cooling

PCB type and with chassis type

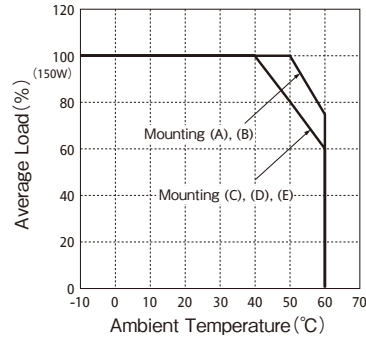

Convection Ta	Average Load (%)				
	Mounting A	B	C	D	E
-10 to 40°C	100	100	100	100	100
50°C	100	100	80	80	80
55°C	85	85	70	70	70
60°C	70	70	60	60	60

With chassis and cover type

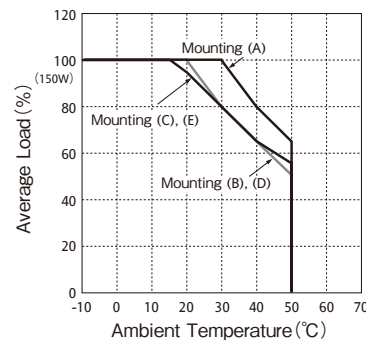

Convection Ta	Average Load (%)				
	Mounting A	B	C	D	E
-10 to 15°C	100	100	100	100	100
20°C	100	100	95	100	95
30°C	100	80	80	80	80
40°C	80	65	65	65	65
50°C	65	50	56	50	56

● Forced air cooling

PCB type and with chassis type

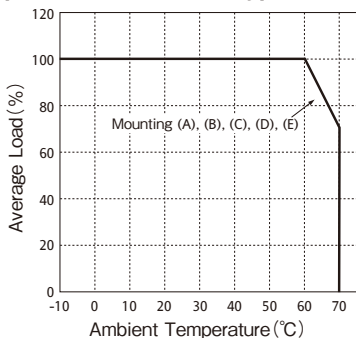

Forced air	Average Load (%)
Mounting	A, B, C, D, E
Ta	-10 to 60°C
	70°C

With chassis and cover type

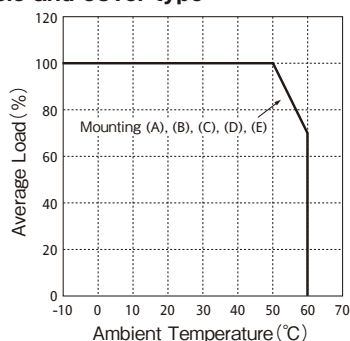

Forced air	Average Load (%)
Mounting	A, B, C, D, E
Ta	-10 to 50°C
	60°C

* Recommended minimum air velocity: 0.7m/s (Measured at component side of PCB, air must flow through component side.) As a reference for forced air cooling, let air flow so that the transformer T1 core temperature is lower than 85°C.

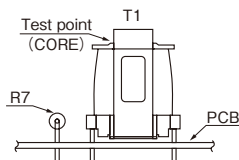

2 Mounting Method

PCB type

Please use the mounting hole (4 holes of $\phi 3.5$) and insert the spacer (MAX $\phi 8.0$) of height over 8mm to lift the unit. Also use all 4 mounting holes for the unit installation. The vibration spec is the value taken when the unit is raised by 8mm spacers.

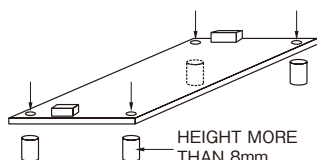

Note: For cases where the unit is often under vibration condition, fix with isolated spacer (non conductive), at the 5th hole, near C6 on the PCB.

The 5th hole diameter: $\phi 3.5$ mm

PCB thickness: 1.6mm

Maximum spacer outer diameter: $\phi 7$ mm

Example:

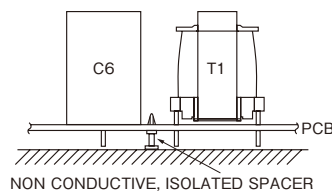

Please leave 4mm space from the surfaces and leave 4mm space from the sides of PCB, especially from the solder surface, 8mm space is necessary. If the space is not enough, the specification of insulation and withstand voltage will not be satisfied.

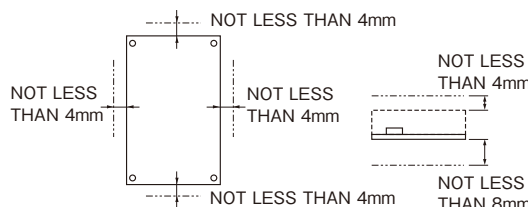

FG should be connected to the earth terminal of the apparatus. If not, the EMI noise and output noise will increase.

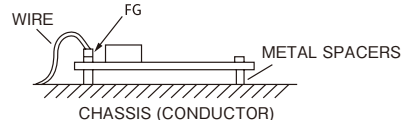

Hatching area is maximum permissible area of metal part for mounting. (9mm from each PCB corners)

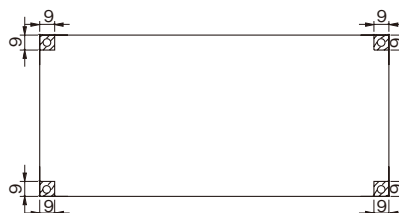

For chassis option /L, chassis & cover option /A

Recommended mounting by following holes A or B, to meet 19.6m/s² vibration specification. Mounting direction (F) & (G) are prohibited as shown in section 4-1. The power supply can be mounted through holes A or B.

A : Embossed tapped and countersunk holes by 4-M4 screws

B : $\phi 4.5$ holes and R2.25 slot hole by 3-M4 screws (For /SL and /SA models, these holes can not be used.)

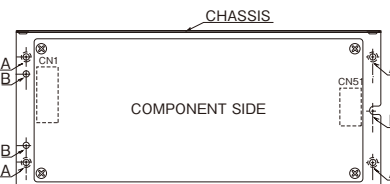

Mounting (F), (G), (H), (I) are prohibited.

For mounting method (J), (K), (L) below, the vibration specification is 6.9m/s², mounted through holes C or D.

Note : Output derating for mounting (J) is same as mounting (C). Output derating for mounting (K) is same as mounting (E). Output derating for mounting (L) is same as mounting (D).

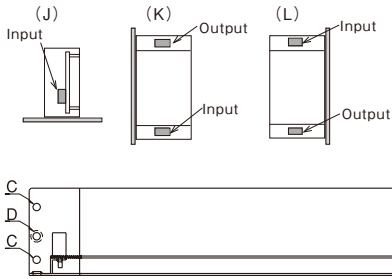

- C: 2- ϕ 4.5 holes and 2-R2.25 slot holes by 4-M4 screws
(For/SL and /SA models, these holes can not be used.)
- D: Embossed tapped and countersunk holes by 2-M4 screws.

5. Wiring Method

- The output load line and input line shall be separated and twisted to improve noise sensitivity.
- Use all lines as thick and short as possible to make lower impedance.
- Noise can be eliminated by attaching a capacitor to the load terminals
- For safety and EMI considerations, connect FG terminal

of input connector and mountable FG to ground terminal of equipment.

- Recommended screw torque is 0.49N.m (5kg.cm)
- Select the wire materials to adapt the MOLEX and J.S.T connector as follows.

INPUT: AWG#22 - #18
OUTPUT: AWG#22 - #18

6. External Fuse Rating

Refer to the following fuse rating when selecting the external fuses that are to be used on input line. Surge current flows when line turns on. Use slow-blow fuse or time-lag type fuse. Do not use fast-blow fuse. Fuse rating is specified by in-rush current value at line turn-on. Do not select

the fuse according to input current (rms.) values under the actual load condition.

ZWS150PAF: 5A

7. Before concluding that the unit is at fault...

Before concluding that the unit is at fault, make the following checks.

- Check if the rated input voltage is connected.
- Check if the wiring of input and output is correct.
- Check if the wire material is not too thin.
- Check if the output voltage control (V.ADJ) is properly adjusted.
- If you use function of the Remote ON/OFF control,

check if the Remote ON/OFF control connector is not opened.

- Check if the output current and output wattage do not exceed specification.
- Audible noise can be heard during dynamic-load operation.
- Audible noise can be heard when input voltage waveform is not sinusoidal wave.

8. Notes

1) Over voltage Category II.

2) Radio Interference Suppression Test is not performed.

9. Repair

In case of damage or repair of this product, please return to our service center or factory.

ZWS240PAF Series Instruction Manual

BEFORE USING THE POWER SUPPLY UNIT

Pay attention to all warnings and cautions before using the unit. Incorrect usage could lead to an electric shock, damage to the unit or a fire hazard.

⚠ WARNING and CAUTION

- Do not modify.
- Do not touch the internal components, they may have high voltage or high temperature. You may get electric shock or burned.
- When the unit is operating, keep your hands and face away from it, you may get injured by an accident.
- This power supply is primarily designed and manufactured to be used and enclosed in other equipment. Stick the WARNING label for users on the system equipment and describe the notice in the instruction manual.
- Never operate the unit under over current or shorted conditions for 30 seconds or more and out of input voltage range in specification which could result in damage or insulation failure or smoking or burning.
- Confirm connections to input/output terminals are correct as indicated in the instruction manual.
- This power supply is PC board type unit. Please hold the board edge while mounting, and do not touch the component

side. Please lift the power supply with a spacer when mounting the power supply on any surface.

- Do not drop or apply shock to power supply unit.
- This power supply is capable of providing hazardous energy output (240VA), the end equipment manufacturer must provide protection to service personal against inadvertent contact with output terminals. These terminals must not be user accessible.
- This power supply has a possibility that hazardous voltage may occur in output terminal depending on failure mode. The outputs of these products must be earthed in the end use equipment to maintain SELV. If the outputs are not earthed, it must be considered hazardous and must not be made user accessible

Note : CE MARKING

CE Marking, when applied to a product covered by this handbook, indicates compliance with the low voltage directive (73/23/EEC) as modified by the CE Marking Directive (93/68/EEC) which complies with EN60950.

1. Terminal Explanation

1 ZWS240PAF

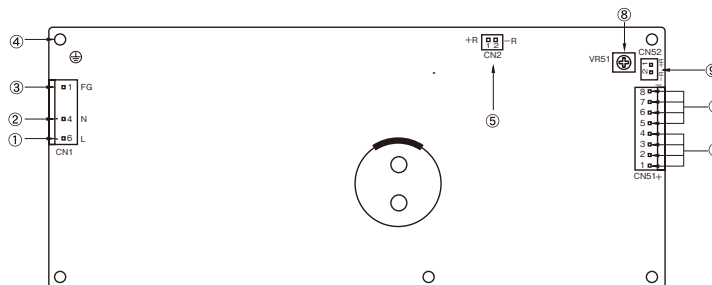

- ① L: AC Input terminal (pin 6 of CN1)
Live line (fuse in line)
- ② N: AC input terminal (pin 4 of CN1)
Neutral line
- ③ FG: Input terminal FG (pin 1 of CN1)
Safety earth (Frame Ground)
Connect to safety ground of apparatus or equipment.
- ④ FG: Frame Ground (Connected to pin 1 of CN1)
Must be connected to electrically safety ground of apparatus or equipment by electrically conductive spacers. The mounting surface of the spacer should be within MAX 8mm.
- ⑤ CN2: ON/OFF control terminal (primary circuit)
See NOTE A
- ⑥ +: +Output terminal
- ⑦ -: - Output terminal
- ⑧ V.ADJ: Output voltage adjust trimmer (VR51)
The output voltage rises when a trimmer is turned clockwise.
- ⑨ CN52: ON/OFF control terminal (secondary circuit)
(For power supply output on and off control with an external signal.)
See NOTE A

● Input & output connector (MOLEX) (also for option model /L, /A)

	Connector	Housing	Terminal Pin
Input (CN1)	5414-30B	5239-06 or 2139-06 or 3069-06	5167PBTL
Output (CN51)	5273-08A	5239-08 or 2139-08 or 3069-08	5167PBTL

* Output current of each connector pin must be less than 5A.
* Hand crimping tooling : JHTR2445A (MOLEX)

● Connector for remote ON/OFF control: CN2, CN52 (J.S.T)

Connector	Housing	Terminal Pin
B2B-XH-AM	XHP-2	BXH-001T-P0.6 or SXH-001T-P0.6

* CN2 is normally shorted by JM-2W-96 (J.S.T).
* Hand crimping tool: YC-110R (J.S.T) or YRS-110 (J.S.T)

NOTE A: For cover & chassis type (model: ZWS240PAF/A), remote ON/OFF control cannot be used.

2 ZWS240PAF/J

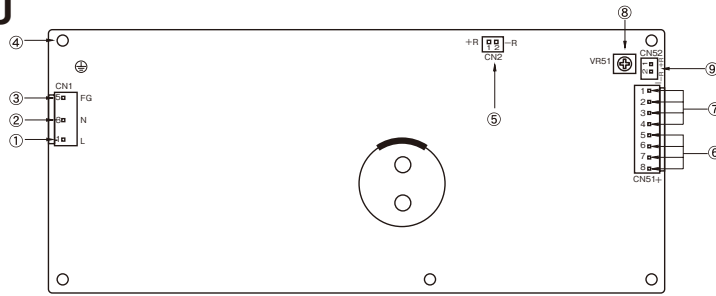

- ① L: AC Input terminal (pin 1 of CN1)
Live line (fuse in line)
- ② N: AC input terminal (pin 3 of CN1)
Neutral line
- ③ FG: Input terminal FG (pin 5 of CN1)
Safety earth (Frame Ground)
Connect to safety ground of apparatus or equipment.
- ④ FG: Frame Ground (Connected to pin 5 of CN1)
Must be connected to electrically safety ground of apparatus or equipment by electrically conductive spacers. The mounting surface of the spacer should be within MAX 8mm.
- ⑤ CN2: ON/OFF control terminal (primary circuit)
See NOTE A
- ⑥ +: +Output terminal
- ⑦ -: -Output terminal
- ⑧ V.ADJ: Output voltage adjust trimmer (VR51)
The output voltage rises when a trimmer is turned clockwise.
- ⑨ CN52: ON/OFF control terminal (secondary circuit)
(For power supply output on and off control with an external signal.) with an external signal.)
See NOTE A

● **Input & output connector (J.S.T)**
(also for option model /JL, /JA)

	Connector	Housing	Terminal Pin
Input (CN1)	B3P-5-VH	VHR-5N	SVH-21T-P1.1
Output (CN51)	B8P-VH	VHR-8N	SVH-21T-P1.1

* Output current of each connector pin must be less than 5A.
* Hand crimping tool : YC-160R (J.S.T)

● **Connector for remote ON/OFF control: CN2, CN52 (J.S.T)**

Connector	Housing	Terminal Pin
B2B-XH-AM	XHP-2	BXH-001T-P0.6 or SXH-001T-P0.6

* CN2 is normally shorted by JM-2W-96 (J.S.T).
* Hand crimping tool: YC-110R (J.S.T) or YRS-110 (J.S.T)

NOTE A: For cover & chassis type (model: ZWS240PAF/JA), remote ON/OFF control cannot be used.

3 ZWS240PAF/T

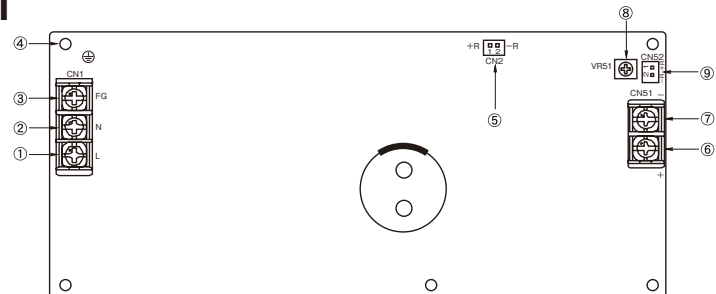

- ① L: AC Input terminal L (M4 screw)
Live line (fuse in line)
- ② N: AC input terminal N (M4 screw)
Neutral line
- ③ FG: Input terminal FG (M4 screw)
Safety earth (Frame Ground)
Connect to safety ground of apparatus or equipment.
- ④ FG: Frame Ground
Must be connected to electrically safety ground of apparatus or equipment by electrically conductive spacers. The mounting surface of the spacer should be within MAX 8mm.
- ⑤ CN2: ON/OFF control terminal (primary circuit)
See NOTE A
- ⑥ +: +Output terminal (M4 screw)
- ⑦ -: -Output terminal (M4 screw)
- ⑧ V.ADJ: Output voltage adjust trimmer (VR51)
The output voltage rises when a trimmer is turned clockwise.
- ⑨ CN52: ON/OFF control terminal (secondary circuit)
(For power supply output on and off control with an external signal.) with an external signal.)
See NOTE A

● **Input & output connector (EMUDEN)**
(also for option model /TL, /TA)

	Connector
Input (CN1)	T6957-A
Output (CN51)	T7094-A

● **Connector for remote ON/OFF control: CN2, CN52 (J.S.T)**

Connector	Housing	Terminal Pin
B2B-XH-AM	XHP-2	BXH-001T-P0.6 or SXH-001T-P0.6

* CN2 is normally shorted by JM-2W-96 (J.S.T).
* Hand crimping tool: YC-110R (J.S.T) or YRS-110 (J.S.T)

NOTE A: For cover & chassis type (model: ZWS240PAF/TA), remote ON/OFF control cannot be used.

4 ZWS240PAF/S

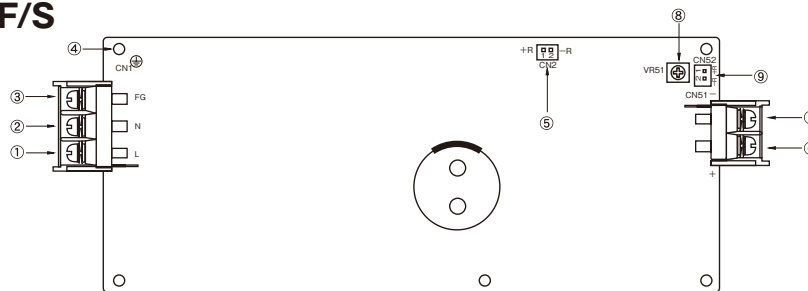

- ① L: AC Input terminal L (M4 screw)
Live line (fuse in line)
- ② N: AC input terminal N (M4 screw)
Neutral line
- ③ FG: Input terminal FG (M4 screw)
Safety earth (Frame Ground)
Connect to safety ground of apparatus or equipment.
- ④ FG: Frame Ground
Must be connected to electrically safety ground of apparatus or equipment by electrically conductive spacers. The mounting surface of the spacer should be within MAX 8mm.
- ⑤ CN2: ON/OFF control terminal (primary circuit)
See NOTE A
- ⑥ +: +Output terminal (M4 screw)
- ⑦ -: -Output terminal (M4 screw)
- ⑧ V.ADJ: Output voltage adjust trimmer (VR51)
The output voltage rises when a trimmer is turned clockwise.
- ⑨ CN52: ON/OFF control terminal (secondary circuit)
(For power supply output on and off control with an external signal.)
See NOTE A

● **Input & output connector (EMUDEN)
(also for option model /SL, /SA)**

	Connector
Input (CN1)	T6969-A
Output (CN51)	T7093-A

● **Connector for remote ON/OFF control:
CN2, CN52 (J.S.T)**

Connector	Housing	Terminal Pin
B2B-XH-AM	XHP-2	BXH-001T-P0.6 or SXH-001T-P0.6

* CN2 is normally shorted by JM-2W-96 (J.S.T).
* Hand crimping tool: YC-110R (J.S.T) or YRS-110 (J.S.T)

NOTE A: For cover & chassis type (model: ZWS240PAF/SA), remote ON/OFF control cannot be used.

2. Terminal Connecting Method

Pay attention to the input wiring. If it is connected to wrong terminal, the power supply will be damaged.

- Input must be off when making connections.
- Connect FG terminal of input connector and mountable FG to ground terminal of the equipment.
- Output current of each connector pin must be less than 5A. (Except /T, /S models which M4 screw is used.)
- The output load line and input line shall be separated and twisted to improve noise sensitivity.
- Remote ON/OFF control lines shall be twisted or use shield-

- ed wire.
- Use the input/output connector housing, terminal pin as specified in outline drawing. Also, use recommended crimping tool.
Connector housing and terminal pin is not included with this product.
- When connecting or removing connector, do not apply stress to PCB.

ZWS240PAF

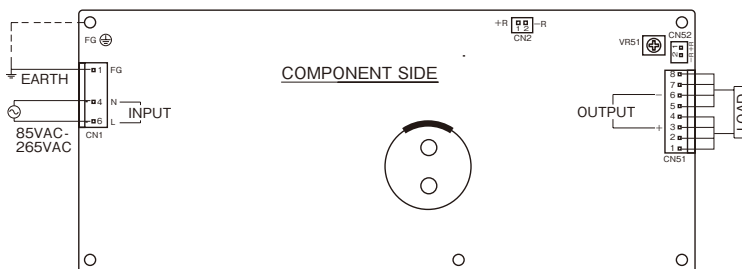

ZWS240PAF/J

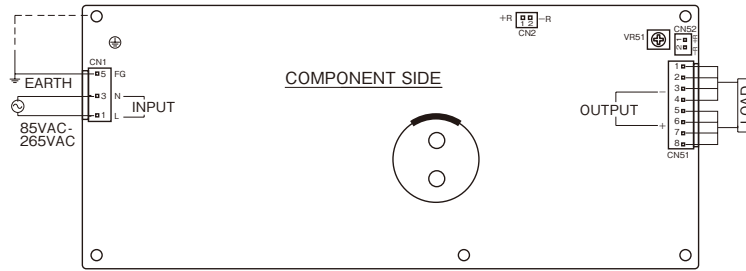

ZWS240PAF/T

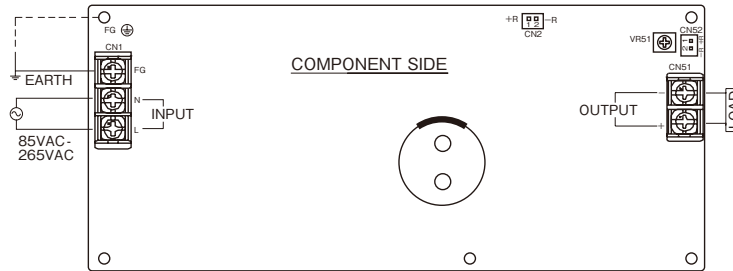

ZWS240PAF/S

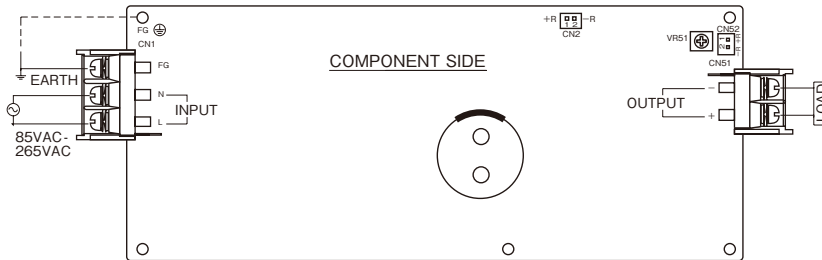

3. Explanation of Functions and Precautions

1 Input Voltage Range

Input voltage range is single phase 85 - 265VAC (47 - 63Hz) or 120 - 370VDC. Input voltage which is out of specification may cause unit damage. For cases where conformance to various safety specs (UL, CSA, EN) are required, input voltage range will be 100 - 240VAC (50/60Hz).

2 Output Voltage Range

V.ADJ trimmer (VR51) that is nearby to output connector is for output voltage adjustment within the range of specifications. To turn the trimmer clockwise, the output voltage will be increased. Note over voltage protection (OVP) function may trigger if the output voltage is increased excessively.

3 Inrush Current

This series has used Power Thermistor to protect the circuit from Inrush Current. Please carefully select input switch and fuse in cases of the high temperature and re-input the power.

4 Over Voltage Protection (OVP)

The OVP function (Inverter shut down method, manual reset type) is provided. OVP function operates within the range of OVP specifications. When OVP triggers, the output will be shut down. The input shall be removed for a few minutes, and then re-input for recovery of the output. OVP setting is fixed and not to be adjusted externally.

5 Over Current Protection (OCP)

Constant current limiting, automatic recovery. OCP function operates when the output current exceeds OCP specifications. The output will be automatically recovered when the overload condition is cancelled. Do not operate overload or dead short conditions for more than 30 seconds, which could result in damage.

6 Over Temperature Protection (OTP)

OTP circuit is built into the power supply to prevent power supply from damage when ambient temperature over the specification.

7 Output Ripple & Noise

The standard specification for maximum ripple value is measured according to measurement circuit specified by JEITA-RC9131. When load lines are longer, ripple becomes larger. In this case, electrolytic capacitor, film capacitor, etc. might be necessary to use across the load terminal. The output ripple cannot be measured accurately if the probe ground lead of oscilloscope is too long.

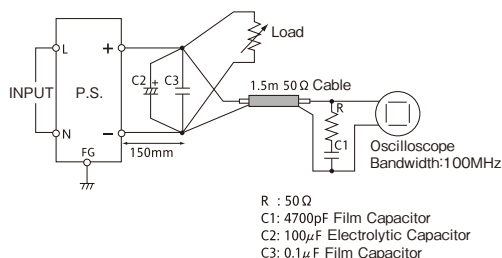

8 Series Operation

For series operation, either method (A) or (B) is possible.

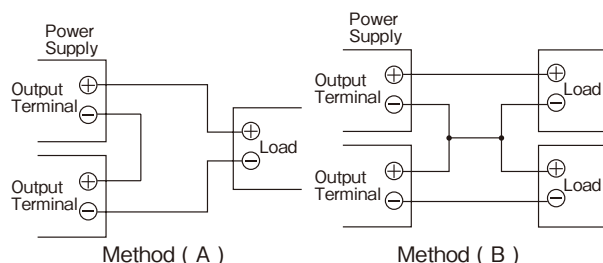

9 Parallel Operation

(A) To increase the output current is not possible.

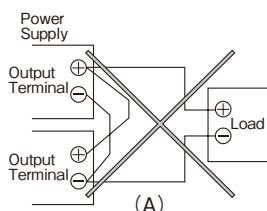

(B) To use as back-up power supply

1. Set power supply output voltage higher by the forward voltage drop (V_F) of diode
2. Adjust the output voltage of each power supply to be the same.
3. Use within the specifications for output voltage and output power.

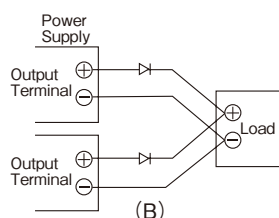

10 Peak Output Current

For ZWS240PAF series, the peak output current should satisfy the conditions below:

- 1) Should not exceed the rated peak current in the specifications. (eg. 20A for ZWS240PAF-24)

- 2) Duty cycle of the peak output current should be < 35%, and operating time of peak output current is less than 10 seconds. If the power supply is operated under convection cooling, and ambient exceeds 45°C, the following operating period for peak current is recommended.

Ambient Temperature (°C)	Peak current operating time
-10 to +45°C	within 10 seconds
+45°C onwards	within 5 seconds

- 3) The relation between peak output current with average output current is defined as below:

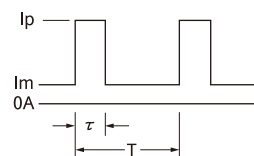

- I_p = Peak output current
- I_m = Minimum output current
- D = Duty cycle, τ / T
- τ = Peak output current operating time
- T = Period
- I_o = Maximum allowable average output current of specifications (I_o should be average load after derating at various mounting and ambient temperature)

Formula:

$$\mathbf{ZWS240PAF: 1.5 \times I_o^2 \geq I_p^2 \times D + I_m^2 \times (1-D)}$$

Example I : For ZWS240PAF-24 at $T_a=60^\circ\text{C}$, Mounting A,
 Max $I_o = 6\text{A}$ (after 60% Derating)

$$1.5 \times I_o^2 \geq I_p^2 \times D + I_m^2 \times (1-D)$$

(A): In case of $I_m=0$, $I_p=20\text{A}$, $D \leq 13.5\%$

(B): In case of $I_m=4\text{A}$, $I_p=20\text{A}$, $D \leq 9.9\%$

Example II: Following table illustrate some peak load operation examples for ZWS240PAF-24.

Please note that the actual I_o in peak load operation is low.

Max allowable average load after derating by various Mounting and T_a :		Examples of peak load derating, calculated by above formula			Actual I_o
Average Load (%)	I_o (A)	I_p (A) max	D max	I_m (A)	I_o (A)
100%	10	20	35.0%	3.92	9.55
90%	9	20	30.4%	0	6.08
80%	8	20	24.0%	0	4.80
70%	7	20	18.4%	0	3.68
60%	6	20	13.5%	0	2.70
50%	5	20	9.4%	0	1.88
40%	4	20	6.0%	0	1.20
30%	3	20	3.4%	0	0.68
20%	2	20	1.5%	0	0.30
10%	1	20	0.4%	0	0.08

11 Remote ON/OFF Control

Remote ON/OFF control (CN2, CN52) function is available. Using this function allows the user to turn the output on and off without having to turn the AC input on and off. Remote ON/OFF control can be used by following 2 modes. However, for Cover and Chassis type (eg. ZWS240PAF/A, /JA, /TA, /SA) cannot be used.

Using CN2

It is controlled by short or open between +R & -R of CN2. CN2 is provided in the primary circuit for ON/OFF control by means of a switch or other device. When using this connector, which is considered to be electrically connected to the mains input voltage, all the requirements of EN60950 must be met with respect to the connector, wiring and switch etc.

In particular :

- 1) Basic insulation must be provided between the ON/OFF control circuit and earth.
- 2) Reinforced insulation must be provided between the ON/OFF control circuit and any secondary circuit or accessible part.
- 3) Wiring must be routed such that damage to the insulation of the wire or additional sleeving cannot occur.
- 4) The switch must meet requirements for reinforced insulation from the ON/OFF control circuit to actuator/accessible parts.

[CN2] The control mode is shown below.

+R & -R Terminal condition	Output condition
Short	ON
Open	OFF

Using CN52

At first, remove short piece of CN2.

It is controlled by the voltage applied to +R and -R. This circuit is in the Secondary (output) side of the power supply unit. Do not connect in the Primary (input) side. And this circuit is isolated from the output by a photo-coupler.

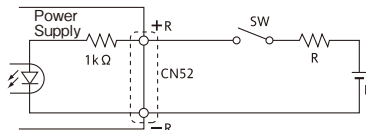

[CN52] The control mode is shown below.

+R & -R terminal condition	Output condition
SW ON (Higher than 4.5V)	ON
SW OFF (Lower than 0.8V)	OFF

External voltage level: E	External resistance: R
4.5 - 12.5VDC	No required
12.5 - 24.5VDC	1.5kΩ

12 Isolation Test

Isolation resistance between output and FG (Chassis) shall be more than 100MΩ at 500VDC. For safety operation, voltage setting of DC isolation tester must be done before the test. Ensure that the it is fully discharged after the test.

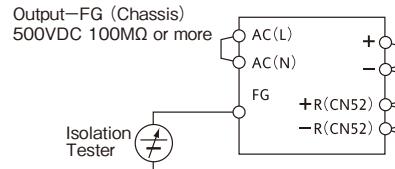

13 Withstand Voltage

This series is designed to withstand 3.0kVAC between input and output, 2.0kVAC between input and FG (Chassis) and 500VAC between output and the FG (Chassis) each for 1 minute. When testing withstand voltage, set current limit of the withstand voltage test equipment to 20mA (Output-FG (Chassis): 100mA). The applied voltage must be gradually increased from zero to the testing value and then gradually decreased for shut down. When timer is used, the power supply may be damaged by high impulse voltage at timer switch on and off. Connect input and output as follows.

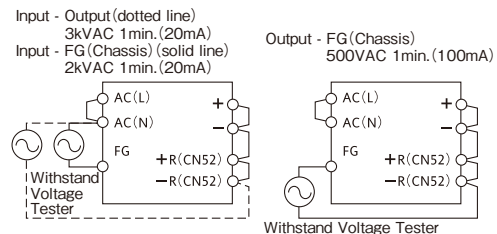

4. Mounting Directions

1 Output Derating according to the Mounting Directions

Recommended standard mounting method is (A). Method (B), (C), (D), (E) are also possible. Mounting (F), (G), (H), (I) are prohibited. Please do not use installation method (F), where the PCB will be on the top side and heat will be trapped inside the unit. Refer to the derating below. In the following derating curve, average load (%) is percent of maximum output load (both maximum output current and maximum output power in specifications). Do not exceed the load deratings.

● PCB type

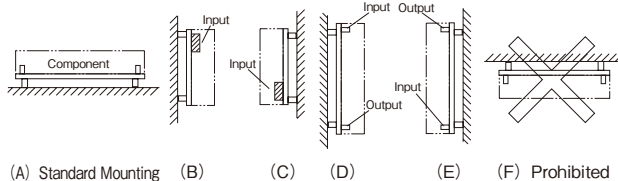

● With chassis, with chassis&cover type

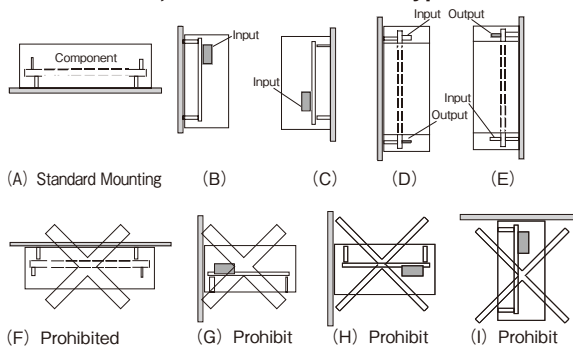

● Forced air cooling
PCB type and with chassis type

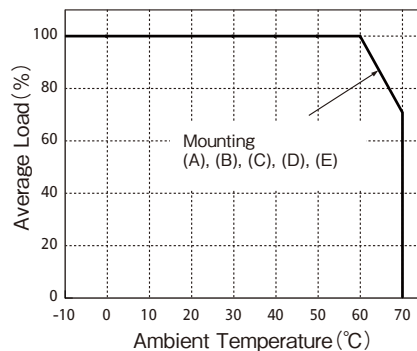

Output Derating

● Convection cooling

PCB type and with chassis type

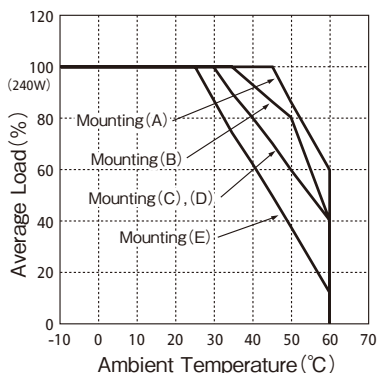

Convection		Average Load (%)				
Ta	Mounting	A	B	C	D	E
-10 to 25°C		100	100	100	100	100
30°C		100	100	100	100	87.5
35°C		100	100	90	90	75
40°C		100	93.3	80	80	62.5
45°C		100	86.7	70	70	50
50°C		86.7	80	60	60	37.5
55°C		73.3	60	50	50	25
60°C		60	40	40	40	12.5

With chassis and cover type

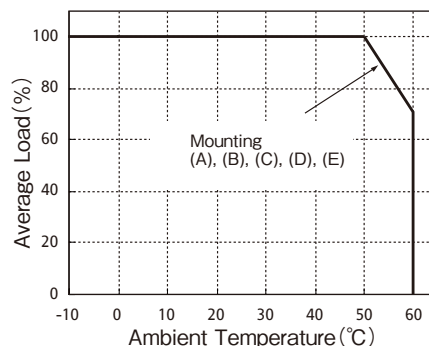

Forced air		Average Load (%)
Mounting		A, B, C, D, E
Ta		-10 to 50°C
		60°C

* Recommended minimum air velocity: 0.7m/s (Measured at component side of PCB, air must flow through component side). As a reference for forced air cooling, let air flow so that the transformer T1 core temperature is lower than 80°C

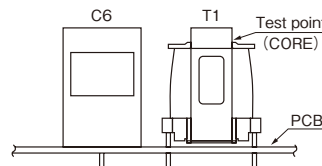

With chassis and cover type

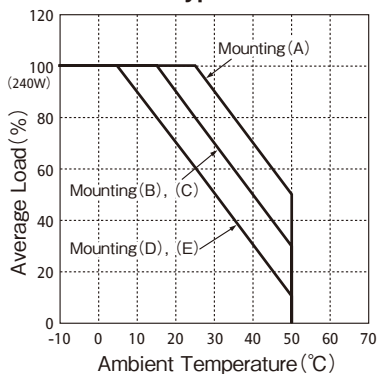

Convection		Average Load (%)				
Ta	Mounting	A	B	C	D	E
-10 to 5°C		100	100	100	100	100
15°C		100	100	100	80	80
25°C		100	80	80	60	60
50°C		50	30	30	10	10

2 Mounting Method

PCB type

Please use the mounting hole (5 holes of $\phi 3.5$) and insert the spacer (MAX $\phi 8.0$) of height over 8mm to lift the unit. Also use all 5 mounting holes for the unit installation. The vibration spec is the value taken when the unit is raised by 8mm spacers.

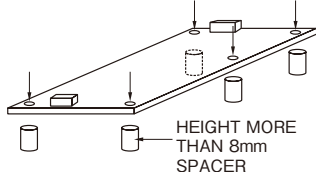

Please leave 4mm space from the surfaces and leave 4mm space from the sides of PCB, especially from the solder surface, 8mm space is necessary. If the space is not enough, the specification of insulation and withstand voltage will not be satisfied.

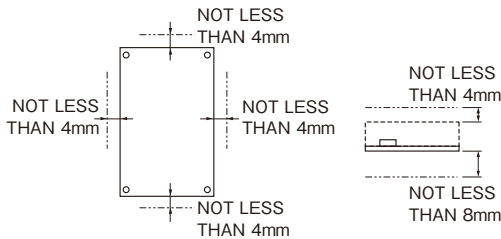

FG should be connected to the earth terminal of the apparatus. If not, the EMI noise and output noise will increase.

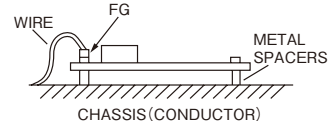

Hatching area is maximum permissible area of metal part for mounting.

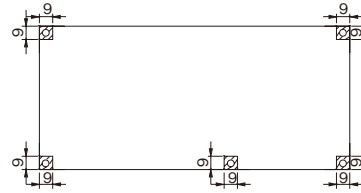

For chassis option /L, chassis & cover option /A

Recommended mounting by following holes A or B, to meet 19.6m/s^2 vibration specification. Mounting direction (F) & (G) are prohibited as shown in section 4-1.

- A: Embossed tapped and countersunk holes by 4-M4 screws
- B: $\phi 4.5$ holes and R2.25 slot hole by 3-M4 screws (For /SL and /SA models, these holes can not be used)

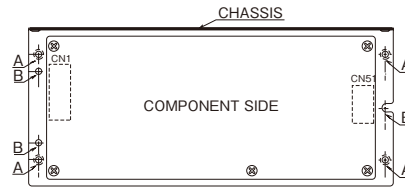

5. Wiring Method

- The output load line and input line shall be separated and twisted to improve noise sensitivity.
- Use all lines as thick and short as possible to make lower impedance.
- Noise can be eliminated by attaching a capacitor to the load terminals.
- For safety and EMI considerations, connect FG terminal of input connector and mountable FG to ground terminal

of equipment.

- Recommended screw torque is 0.49N.m (5kg.cm)
- Select the wire materials to adapt the MOLEX and J.S.T connector as follows.

INPUT: AWG#22 - #18

OUTPUT: AWG#22 - #18

6. External Fuse Rating

Refer to the following fuse rating when selecting the external fuses that are to be used on input line. Surge current flows when line turns on. Use slow-blow fuse or time-lag type fuse. Do not use fast-blow fuse. Fuse rating is specified by in-rush current value at line turn-on. Do not select the fuse according to input current (rms.) values under the actual load condition.

ZWS240PAF: 6.3A

7. Before concluding that the unit is at fault...

Before concluding that the unit is at fault, make the following checks.

- Check if the rated input voltage is connected.
- Check if the wiring of input and output is correct.
- Check if the wire material is not too thin.
- Check if the output voltage control (V.ADJ) is properly adjusted.
- If you use function of the Remote ON/OFF control, check if the Remote ON/OFF control connector is not opened.
- Check if the output current and output wattage do not over specification.
- Audible noise can be heard during dynamic-load operation.
- Audible noise can be heard when input voltage waveform is not sinusoidal wave.

8. Notes

- 1) Over voltage Category II.
- 2) Radio Interference Suppression Test is not performed.

9. Repair

In case of damage or repair of this product, please return to our service center or factory.

TDK-Lambda