

## 74FR16541 16-Bit Buffer/Line Driver with 3-STATE Outputs

### General Description

The 'FR16541 contains sixteen non-inverting buffers with 3-STATE outputs designed to be employed as a memory and address driver, clock driver, or bus-oriented transmitter/receiver. The device is byte controlled. Each byte has separate 3-STATE control inputs which can be shorted together for full 16-bit operation.

- 3-STATE outputs drive bus lines
- Output sink capability of 64 mA, source capability of 15 mA
- Separate 3-STATE control pins for each byte
- Guaranteed 4000V minimum ESD protection
- Guaranteed multiple output switching, 250 pF delays and pin-to-pin skew
- 16-bit version of the 'F541, 'F244 or 'FR244

### Features

- Non-inverting buffers

### Ordering Code:

Commercial	Package Number	Package Description
74FR16541QC	V44A	44-Lead Molded Plastic Leaded Chip Carrier (PLCC)
74FR16541SSC (Note 1)	MS48A	48-Lead (0.300" Wide) Molded Shrink Small Outline, JEDEC (SSOP)

Note 1: Devices also available in 13" reel. Use suffix = SSCX.

### Logic Symbol

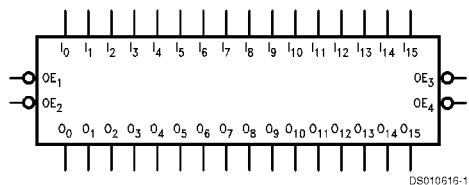

### Pin Descriptions

Pin Names	Description
$\overline{OE}_n$	Output Enable Inputs
$I_0$ - $I_{15}$	Inputs
$O_0$ - $O_{15}$	3-STATE Outputs

## Connection Diagrams

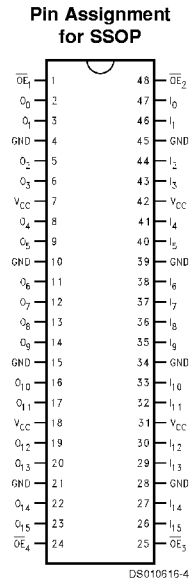
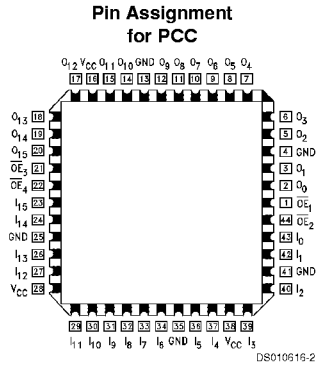

## Truth Table

Inputs				Outputs			
Byte1 [0:7]		Byte2 [8:15]		I <sub>0</sub> -I <sub>7</sub>	I <sub>8</sub> -I <sub>15</sub>	O <sub>0</sub> -O <sub>7</sub>	O <sub>8</sub> -O <sub>15</sub>
OE1	OE2	OE3	OE4				
L	L	L	L	H	H	H	H
H	X	L	L	X	L	Z	L
X	H	L	L	X	H	Z	H
L	L	H	X	L	X	L	Z
L	L	X	H	H	X	H	Z
H	H	H	H	X	X	Z	Z
L	L	L	L	L	L	L	L

H = High Voltage Level  
 L = Low Voltage Level  
 X = Immaterial  
 Z = High Impedance

## Logic Diagram

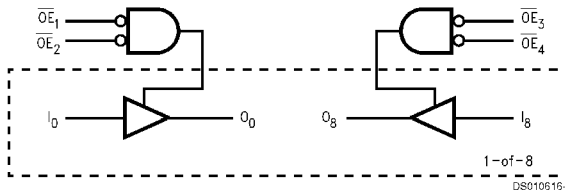

## Absolute Maximum Ratings (Note 2)

Storage Temperature	-65°C to +150°C
Ambient Temperature under Bias	-55°C to +125°C
Junction Temperature under Bias	-55°C to +175°C
Plastic	-55°C to +150°C
V <sub>CC</sub> Pin Potential to Ground Pin	-0.5V to +7.0V
Input Voltage (Note 3)	-0.5V to +7.0V
Input Current (Note 3)	-30 mA to +5.0 mA
Voltage Applied to Output in HIGH State (with V <sub>CC</sub> = 0V)	
Standard Output	-0.5V to V <sub>CC</sub>
3-STATE Output	-0.5V to +5.5V
Current Applied to Output	

in LOW State (Max) Twice the Rated I<sub>OL</sub> (mA)  
ESD Last Passing Voltage (Min) 4000V

## Recommended Operating Conditions

Free Air Ambient Temperature	
Commercial	0°C to +70°C
Supply Voltage	
Commercial	+4.5V to +5.5V

**Note 2:** Absolute maximum ratings are values beyond which the device may be damaged or have its useful life impaired. Functional operation under these conditions is not implied.

**Note 3:** Either voltage limit or current limit is sufficient to protect inputs.

## DC Electrical Characteristics

Symbol	Parameter	74F			Units	V <sub>CC</sub>	Conditions
		Min	Typ	Max			
V <sub>IH</sub>	Input HIGH Voltage	2.0			V		Recognized as a HIGH Signal
V <sub>IL</sub>	Input LOW Voltage			0.8	V		Recognized as a LOW Signal
V <sub>CD</sub>	Input Clamp Diode Voltage			-1.2	V	Min	I <sub>IN</sub> = -18 mA
V <sub>OH</sub>	Output HIGH Voltage	2.4			V	Min	I <sub>OH</sub> = -3 mA I <sub>OH</sub> = -15 mA
V <sub>OL</sub>	Output LOW Voltage			0.55	V	Min	I <sub>OL</sub> = 64 mA
I <sub>IH</sub>	Input HIGH Current			5.0	μA	Max	V <sub>IN</sub> = 2.7V
I <sub>BVI</sub>	Input HIGH Current Breakdown Test			7.0	μA	Max	V <sub>IN</sub> = 7.0V ( $\overline{O}E_n$ )
I <sub>IL</sub>	Input LOW Current			-120	μA	Max	V <sub>IN</sub> = 0.5V
I <sub>OS</sub>	Output Short-Circuit Current	-100		-225	mA	Max	V <sub>OUT</sub> = 0V
I <sub>OZH</sub>	Output Leakage Current		0	20	μA	Max	V <sub>OUT</sub> = 2.7V
I <sub>OZL</sub>	Output Leakage Current		0	-20	μA	Max	V <sub>OUT</sub> = 0.5V
I <sub>CEX</sub>	Output HIGH Leakage Current			50	μA	Max	V <sub>OUT</sub> = V <sub>CC</sub>
V <sub>ID</sub>	Input Leakage Test	4.75			V	0.0	I <sub>ID</sub> = 1.9 μA All Other Pins Grounded
I <sub>OD</sub>	Output Circuit Leakage Current			3.75	μA	0.0	V <sub>IOD</sub> = 150 mV All Other Pins Grounded
I <sub>ZZ</sub>	Bus Drainage Test			100	μA	0.0	V <sub>OUT</sub> = 5.25V
I <sub>CCH</sub>	Power Supply Current		35	50	mA	Max	V <sub>O</sub> = HIGH
I <sub>CCL</sub>	Power Supply Current		92	110	mA	Max	V <sub>O</sub> = LOW
I <sub>CCZ</sub>	Power Supply Current		36	50	mA	Max	V <sub>O</sub> = HIGH Z
C <sub>IN</sub>	Input Capacitance		8		pF	5.0	

## AC Electrical Characteristics

Symbol	Parameter	74FR			74FR		Units
		T <sub>A</sub> = +25°C V <sub>CC</sub> = +5.0V C <sub>L</sub> = 50 pF			T <sub>A</sub> = Comm V <sub>CC</sub> = Comm C <sub>L</sub> = 50 pF		
		Min	Typ	Max	Min	Max	
t <sub>PLH</sub>	Propagation Delay	1.5	2.8	4.3	1.5	4.3	ns
t <sub>PHL</sub>	In to On	1.5	2.4	4.3	1.5	4.3	
t <sub>PZH</sub>	Output Enable Time	3.6	5.8	11.6	3.6	11.6	ns
t <sub>PZL</sub>		3.6	6.6	11.6	3.6	11.6	
t <sub>PHZ</sub>	Output Disable Time	1.8	4.0	6.6	1.8	6.6	ns
t <sub>PLZ</sub>		1.8	4.1	6.6	1.8	6.6	

## Extended AC Characteristics

Symbol	Parameter	74FR		74FR		Units
		T <sub>A</sub> = Comm V <sub>CC</sub> = Comm C <sub>L</sub> = 50 pF 16 Outputs Switching (Note 5)		T <sub>A</sub> = Comm V <sub>CC</sub> = Comm C <sub>L</sub> = 250 pF  (Note 6)		
		Min	Max	Min	Max	
t <sub>PLH</sub>	Propagation Delay	1.5	5.7	3.0	9.0	ns
t <sub>PHL</sub>	An to Bn or Bn to An	1.5	5.7	3.0	9.0	
t <sub>PZH</sub>	Output Enable Time	3.6	12.5			ns
t <sub>PZL</sub>		3.6	12.5			
t <sub>PHZ</sub>	Output Disable Time	1.8	6.6			ns
t <sub>PLZ</sub>		1.8	6.6			
t <sub>osHL</sub> (Note 4)	Pin to Pin Skew for HL Transitions		1.5			ns
t <sub>osLH</sub> (Note 4)	Pin to Pin Skew for LH Transitions		1.3			ns
t <sub>ost</sub> (Note 4)	Pin to Pin Skew for HL/LH Transitions		2.0			ns

**Note 4:** Skew is defined as the absolute value of the difference between the actual propagation delays for any two outputs of the same device. The specification applies to any outputs switching HIGH to LOW, (t<sub>osHL</sub>), LOW to HIGH, (t<sub>osLH</sub>), or HIGH to LOW and/or LOW to HIGH, (t<sub>ost</sub>). Specifications guaranteed with all outputs switching in phase.

**Note 5:** This specification is guaranteed but not tested. The limits apply to propagation delays for all paths described switching in phase, i.e., all LOW-to-HIGH, HIGH-to-LOW, 3-STATE-to-High, etc.

**Note 6:** These specifications guaranteed but not tested. The limits represent propagation delays with 250 pF load capacitors in place of the 50 pF load capacitors in the standard AC load. This specification pertains to single output switching only.

## Ordering Information

The device number is used to form part of a simplified purchasing code where a package type and temperature range are defined as follows:

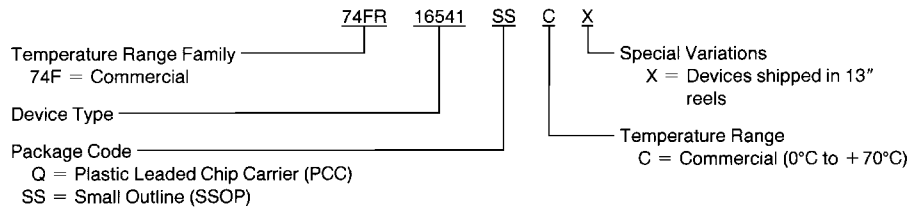

DS010516-5

## Physical Dimensions

inches (millimeters) unless otherwise noted

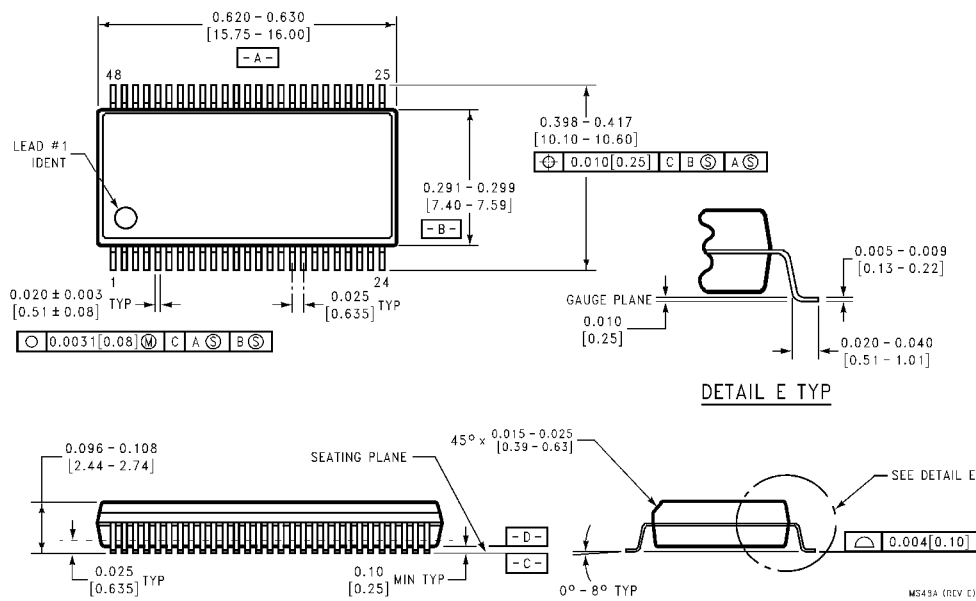

**48-Lead (0.300" Wide) Molded Shrink Small Outline Package, JEDEC (SS)**  
**Package Number MS48A**

**Physical Dimensions** inches (millimeters) unless otherwise noted (Continued)

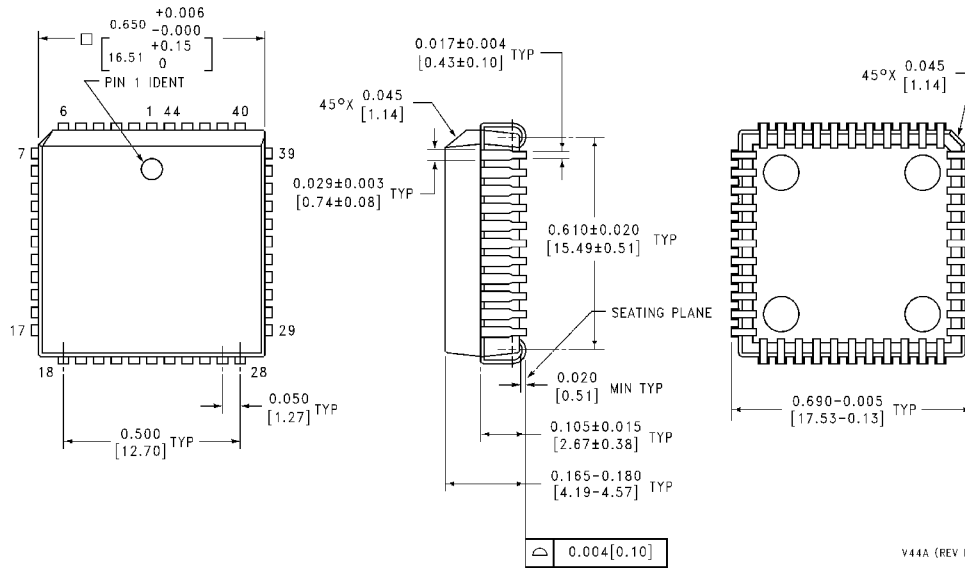

**44-Lead Molded Plastic Chip Carrier (Q)  
Package Number V44A**

V44A (REV K)

**LIFE SUPPORT POLICY**

FAIRCHILD'S PRODUCTS ARE NOT AUTHORIZED FOR USE AS CRITICAL COMPONENTS IN LIFE SUPPORT DEVICES OR SYSTEMS WITHOUT THE EXPRESS WRITTEN APPROVAL OF THE PRESIDENT OF FAIRCHILD SEMICONDUCTOR CORPORATION. As used herein:

1. Life support devices or systems are devices or systems which, (a) are intended for surgical implant into the body, or (b) support or sustain life, and (c) whose failure to perform when properly used in accordance with instructions for use provided in the labeling, can be reasonably expected to result in a significant injury to the user.
2. A critical component in any component of a life support device or system whose failure to perform can be reasonably expected to cause the failure of the life support device or system, or to affect its safety or effectiveness.

**Fairchild Semiconductor Corporation Americas**  
Customer Response Center  
Tel: 1-888-522-5372

**Fairchild Semiconductor Europe**  
Fax: +49 (0) 1 80-530 85 86  
Email: europe.support@nsc.com  
Deutsch Tel: +49 (0) 8 141-35-0  
English Tel: +44 (0) 1 793-85-68-56  
Italy Tel: +39 (0) 2 57 5631

**Fairchild Semiconductor Hong Kong Ltd.**  
13th Floor, Straight Block,  
Ocean Centre, 5 Canton Rd.  
Tsimshatsui, Kowloon  
Hong Kong  
Tel: +852 2737-7200  
Fax: +852 2314-0061

**National Semiconductor Japan Ltd.**  
Tel: 81-3-5620-6175  
Fax: 81-3-5620-6179

[www.fairchildsemi.com](http://www.fairchildsemi.com)